



Data and Signal Line Chokes / Common-mode Filters

Series/Type: B82789C0

The following products presented in this data sheet are being withdrawn.

Ordering Code	Substitute Product	Date of Withdrawal	Deadline Last Orders	Last Shipments
B82789C0513H001	B82789C0513H002	2025-10-31	2026-03-31	2026-10-31
B82789C0223N001	B82789C0223N002	2025-10-31	2026-03-31	2026-10-31
B82789C0223H001	B82789C0223H002	2025-10-31	2026-03-31	2026-10-31



Ordering Code	Substitute Product	Date of Withdrawal	Deadline Last Orders	Last Shipments
B82789C0113N001	B82789C0113N002	2025-10-31	2026-03-31	2026-10-31
B82789C0113H001	B82789C0113H002	2025-10-31	2026-03-31	2026-10-31
B82789C0104N001	B82789C0104N002	2025-10-31	2026-03-31	2026-10-31
B82789C0104H001	B82789C0104H002	2025-10-31	2026-03-31	2026-10-31
B82789C0513N001	B82789C0513N002	2025-10-31	2026-03-31	2026-10-31
B82789S0223H001	B82789S0223H002	2025-10-31	2026-03-31	2026-10-31
B82789S0223N001	B82789S0223N002	2025-10-31	2026-03-31	2026-10-31

Please contact your nearest TDK sales office if you need support in selecting a suitable substitute. The addresses of our worldwide sales network are presented at www.tdk-electronics.tdk.com/sales.

SMD

Rated voltage 42 V AC/80 V DC

Rated inductance 11 ... 100 μ H

Rated current 150 ... 300 mA

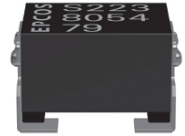

Construction

- Current-compensated double choke
- Ferrite I core
- Winding: enamel copper wire
- Winding welded to terminals
- Bifilar winding (B82789C0...)
- Sector winding (B82789S0...)

Features

- Temperature range up to +150 °C (B82789C0/S0*H)
- Suitable for lead-free reflow soldering as referenced in JEDEC J-STD 020D
- For gold-plated terminals conductive adhesion possible
- Qualified to AEC-Q200
- RoHS-compatible

Function

- B82789C0:
Suppression of asymmetrical interference coupled in on lines, whereas data signals up to some MHz can pass unaffectedly.
- B82789S0:
Suppression of asymmetrical (by L_R) and symmetrical interference (by L_{stray}) coupled in on lines. The high-frequency portions of the symmetrical data signal are decreased so far that EMC problems can be significantly reduced.

Applications

- Automotive applications, e.g. CAN and FlexRay bus
- Industrial field bus systems
- Line cards for telecom

Terminals

Tinned terminals (B82789C0/S0*002)

- Base material CuSn6
- Layer composition Ni, Ag, Sn¹⁾
- Lead-free tinned

Gold-plated terminals (B82789C0/S0*001)

- Base material CuSn6
- Layer composition Ni, Ag, Au
- Gold plated

1) Ni-barrier-plated terminals (NiSn) on request (B82789C0/S0*H052).

SMD**Marking**

- Marking on component:
Manufacturer, bifilar or sector winding (coded),
L value (in nH; for version B82789C0/S0*H052 underlined),
date of manufacture (YWWD), two last digits of production order
- Minimum data on reel:
Manufacturer, ordering code, L value (in nH), quantity, date of packing

Delivery mode and packing unit

- 12-mm blister tape, wound on 330-mm \varnothing reel
- Packing unit: 2500 pcs./reel

SIMDAD 1812, common-mode chokes

SMD

Dimensional drawing and pin configuration

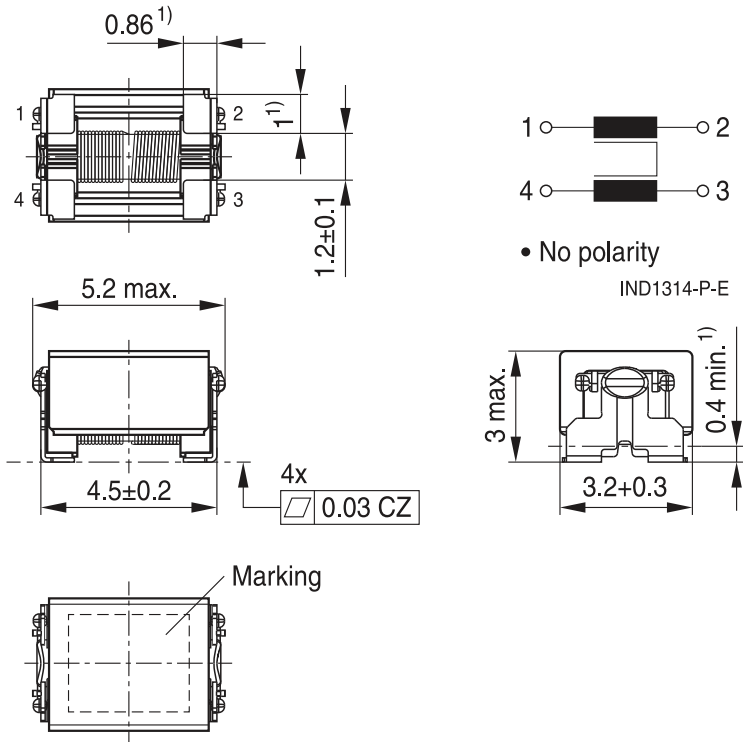

¹⁾ Soldering area

IND1305-G-E

Layout recommendation

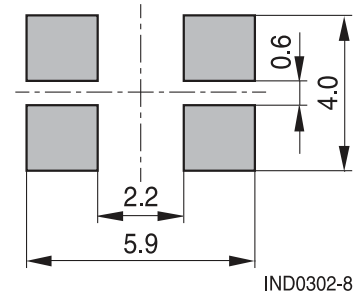

Dimensions in mm

Taping and packing

Blister tape

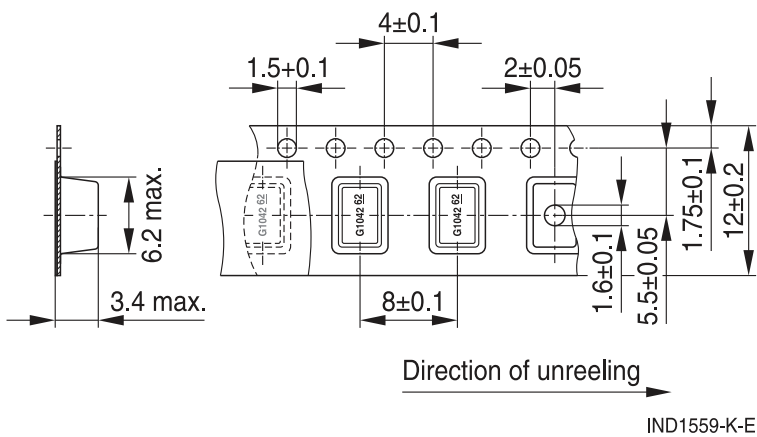

Reel

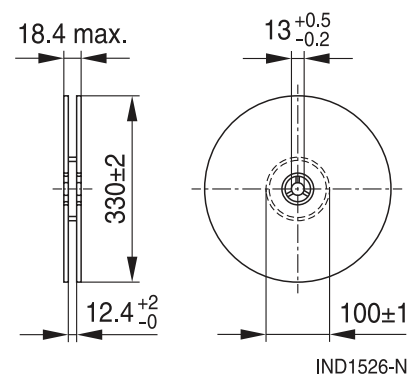

Dimensions in mm

SMD
Technical data and measuring conditions

Rated voltage V_R	42 V AC (50/60 Hz) / 80 V DC
Test voltage V_{test}	250 V DC, 2 s (line/line)
Rated temperature T_R	+85 °C / +110 °C
Rated current I_R	Referred to 50 Hz and rated temperature
Rated inductance L_R	Measured with Agilent 4284A at 100 kHz, 0.1 mA, +20 °C Inductance is specified per winding.
Inductance tolerance	-30/+50% at +20 °C
Inductance decrease $\Delta L/L_0$	Common mode < 10% at DC magnetic bias with I_R , +20 °C
Stray inductance $L_{stray,typ}$	Measured with Agilent 4284A at 100 kHz, 5 mA, +20 °C, typical values
DC resistance R_{max}	Measured at +20 °C, specified per winding
Solderability (lead-free)	Dip and look method Sn95.5Ag3.8Cu0.7: +(245 ±5) °C, (3 ±0.3) s Wetting of soldering area ≥ 90% (based on IEC 60068-2-58)
Resistance to soldering heat	+260 °C, 40 s as referenced in JEDEC J-STD 020D
Climatic category	55/125/56 (B82789*N) 55/150/56 (B82789*H) (to IEC 60068-1)
Storage conditions	Mounted: -55 °C ... +125 °C (B82789C0/S0*N) -55 °C ... +150 °C (B82789C0/S0*H) Packaged: -25 °C ... +40 °C, ≤ 75% RH
Weight	Approx. 0.16 g

SMD
Characteristics and ordering codes

L_R	$L_{\text{stray,typ}}$	I_R	R_{max}	T_R	Ordering code	
					Gold-plated terminals	Tinned terminals
μH	μH	mA	$\text{m}\Omega$	$^{\circ}\text{C}$		
B82789C0/S0*N (operating temperature: $-55 \dots +125 \text{ }^{\circ}\text{C}$)						
11	0.06	300	250	85	B82789C0113N001	B82789C0113N002
22	0.10	250	580	85	B82789C0223N001	B82789C0223N002
22	3.0	250	580	85	B82789S0223N001	B82789S0223N002
51	0.10	250	550	85	B82789C0513N001	B82789C0513N002
100	0.25	150	1500	85	B82789C0104N001	B82789C0104N002
B82789C0/S0*H (operating temperature: $-55 \dots +150 \text{ }^{\circ}\text{C}$)						
11	0.06	300	250	110	B82789C0113H001	B82789C0113H002 ¹⁾
22	0.10	250	580	110	B82789C0223H001	B82789C0223H002 ¹⁾
22	3.0	250	580	110	B82789S0223H001	B82789S0223H002 ¹⁾
51	0.10	250	550	110	B82789C0513H001	B82789C0513H002 ¹⁾
100	0.25	150	1500	110	B82789C0104H001	B82789C0104H002 ¹⁾

1) Replace the two last digits "02" by "52" for Ni-barrier-plated terminals.

SIMDAD 1812, common-mode chokes

SMD

Insertion loss α (typical values at $|Z| = 50 \Omega$, $+20 \text{ }^\circ\text{C}$)

———— asymmetrical, all branches in parallel (common mode)

- - - - - symmetrical (differential mode)

$L_R = 11 \mu\text{H}$

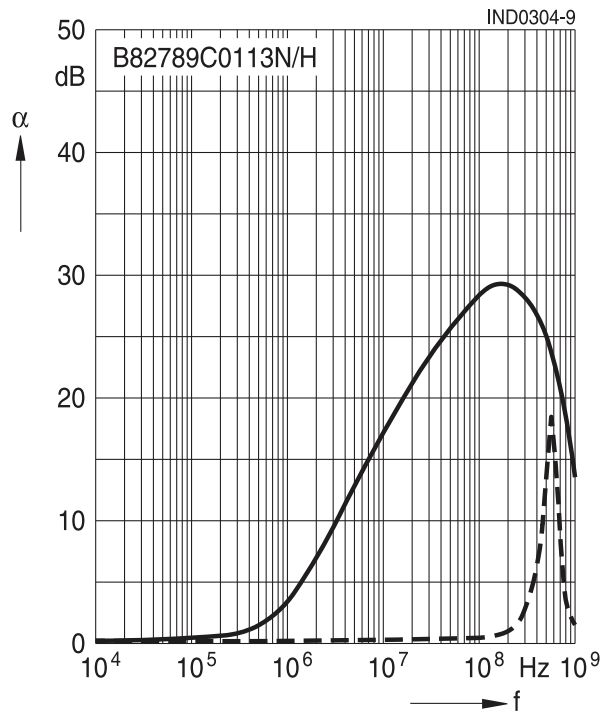

$L_R = 22 \mu\text{H}$ (low L_{stray})

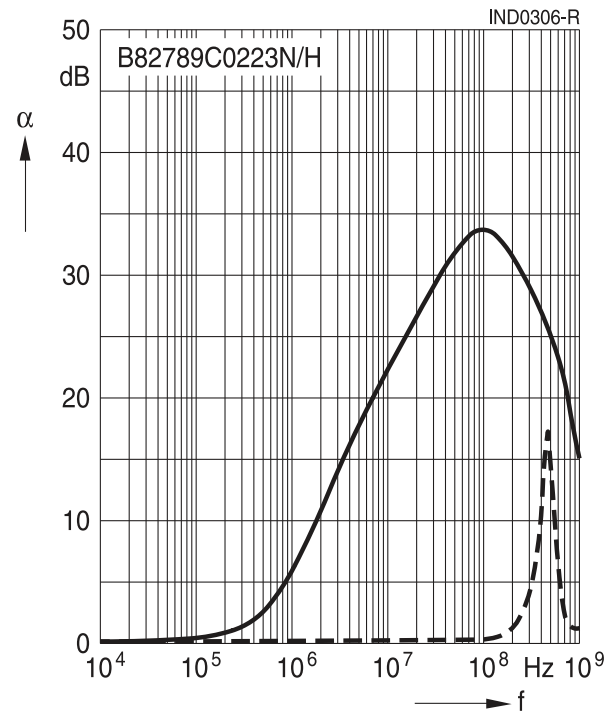

$L_R = 22 \mu\text{H}$ (high L_{stray})

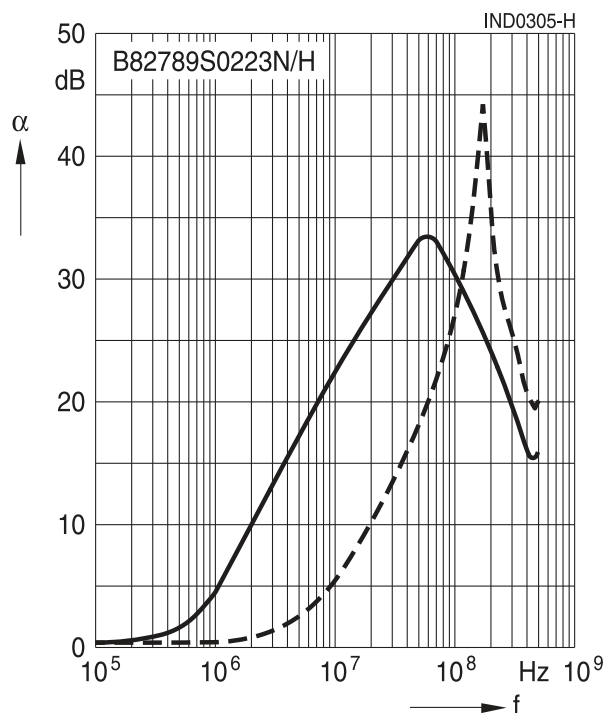

$L_R = 51 \mu\text{H}$

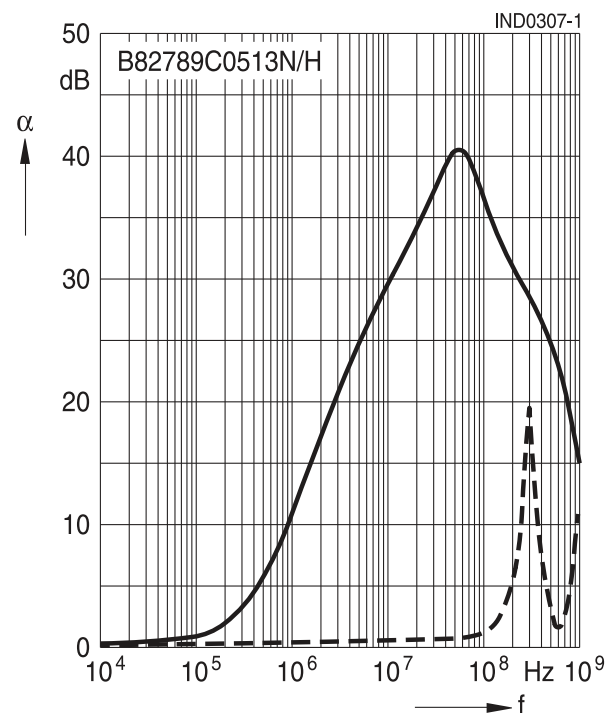

Data and signal line chokes **B82789C0/S0**
SIMDAD 1812, common-mode chokes

SMD

Insertion loss α (typical values at $|Z| = 50 \Omega$, $+20 \text{ }^\circ\text{C}$)

- asymmetrical, all branches in parallel (common mode)
- - - - - symmetrical (differential mode)

$L_R = 100 \mu\text{H}$

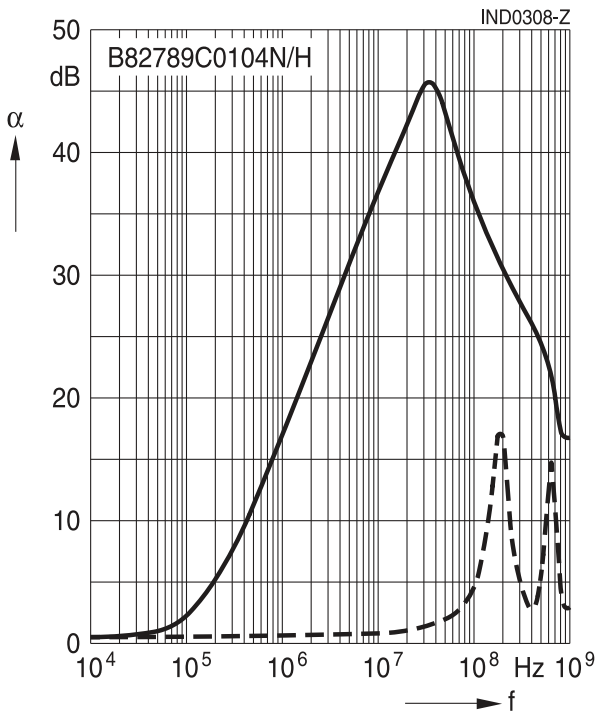

Current derating I_{op}/I_R versus ambient temperature (rated temperature $T_R = +85 \text{ }^\circ\text{C}$)

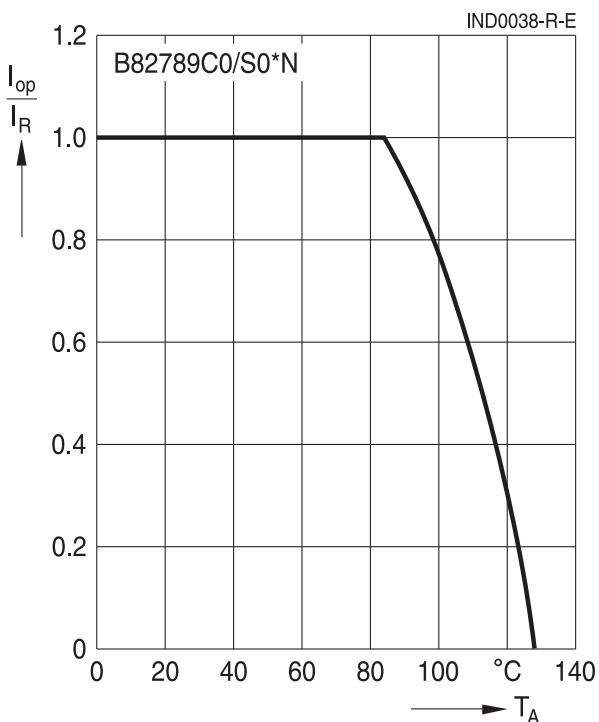

Current derating I_{op}/I_R versus ambient temperature (rated temperature $T_R = +110 \text{ }^\circ\text{C}$)

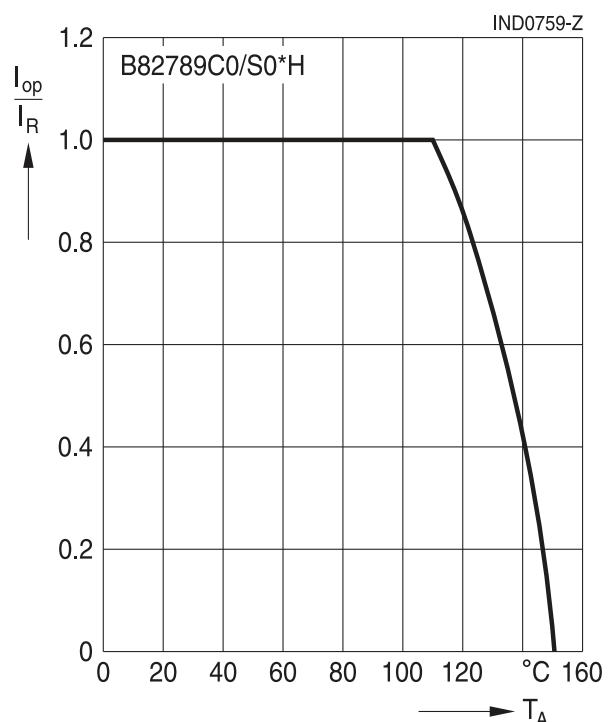

Cautions and warnings

- Please note the recommendations in our Inductors data book (latest edition) and in the data sheets.
 - Particular attention should be paid to the derating curves given there.
 - The soldering conditions should also be observed. Temperatures quoted in relation to wave soldering refer to the pin, not the housing.
- If the components are to be washed varnished it is necessary to check whether the washing varnish agent that is used has a negative effect on the wire insulation, any plastics that are used, or on glued joints. In particular, it is possible for washing varnish agent residues to have a negative effect in the long-term on wire insulation.
Washing processes may damage the product due to the possible static or cyclic mechanical loads (e.g. ultrasonic cleaning). They may cause cracks to develop on the product and its parts, which might lead to reduced reliability or lifetime.
- The following points must be observed if the components are potted in customer applications:
 - Many potting materials shrink as they harden. They therefore exert a pressure on the plastic housing or core. This pressure can have a deleterious effect on electrical properties, and in extreme cases can damage the core or plastic housing mechanically.
 - It is necessary to check whether the potting material used attacks or destroys the wire, wire insulation, plastics or glue.
 - The effect of the potting material can change the high-frequency behaviour of the components.
 - Many coating materials have a negative effect (chemically and mechanically) on the winding wires, insulation materials and connecting points. Customers are always obligated to determine whether and to what extent their coating materials influence the component.
Customers are responsible and bear all risk for the use of the coating material. TDK Electronics does not assume any liability for failures of our components that are caused by the coating material.
- Ceramics / Ferrites are sensitive to direct impact. This can cause the core material to flake, or lead to breakage of the core.
- Even for customer-specific products, conclusive validation of the component in the circuit can only be carried out by the customer.

Display of ordering codes for TDK Electronics products

The ordering code for one and the same product can be represented differently in data sheets, data books, other publications, on the company website, or in order-related documents such as shipping notes, order confirmations and product labels. **The varying representations of the ordering codes are due to different processes employed and do not affect the specifications of the respective products.** Detailed information can be found on the Internet under www.tdk-electronics.tdk.com/orderingcodes.

Important notes

The following applies to all products named in this publication:

1. Some parts of this publication contain **statements about the suitability of our products for certain areas of application**. These statements are based on our knowledge of typical requirements that are often placed on our products in the areas of application concerned. We nevertheless expressly point out **that such statements cannot be regarded as binding statements about the suitability of our products for a particular customer application**. As a rule, we are either unfamiliar with individual customer applications or less familiar with them than the customers themselves. For these reasons, it is always ultimately incumbent on the customer to check and decide whether a product with the properties described in the product specification is suitable for use in a particular customer application.
2. We also point out that **in individual cases, a malfunction of electronic components or failure before the end of their usual service life cannot be completely ruled out in the current state of the art, even if they are operated as specified**. In customer applications requiring a very high level of operational safety and especially in customer applications in which the malfunction or failure of an electronic component could endanger human life or health (e.g. in accident prevention or life-saving systems), it must therefore be ensured by means of suitable design of the customer application or other action taken by the customer (e.g. installation of protective circuitry or redundancy) that no injury or damage is sustained by third parties in the event of malfunction or failure of an electronic component.
3. **The warnings, cautions and product-specific notes must be observed.**
4. In order to satisfy certain technical requirements, **some of the products described in this publication may contain substances subject to restrictions in certain jurisdictions (e.g. because they are classed as hazardous)**. Useful information on this will be found in our Material Data Sheets on the Internet (www.tdk-electronics.tdk.com/material). Should you have any more detailed questions, please contact our sales offices.
5. We constantly strive to improve our products. Consequently, **the products described in this publication may change from time to time**. The same is true of the corresponding product specifications. Please check therefore to what extent product descriptions and specifications contained in this publication are still applicable before or when you place an order.
We also **reserve the right to discontinue production and delivery of products**. Consequently, we cannot guarantee that all products named in this publication will always be available. The aforementioned does not apply in the case of individual agreements deviating from the foregoing for customer-specific products.
6. Unless otherwise agreed in individual contracts, **all orders are subject to our General Terms and Conditions of Supply**.

Important notes

7. **Our manufacturing sites serving the automotive business apply the IATF 16949 standard.**
The IATF certifications confirm our compliance with requirements regarding the quality management system in the automotive industry. Referring to customer requirements and customer specific requirements (“CSR”) TDK always has and will continue to have the policy of respecting individual agreements. Even if IATF 16949 may appear to support the acceptance of unilateral requirements, we hereby like to emphasize that **only requirements mutually agreed upon can and will be implemented in our Quality Management System.** For clarification purposes we like to point out that obligations from IATF 16949 shall only become legally binding if individually agreed upon.
8. The trade names EPCOS, CeraCharge, CeraDiode, CeraLink, CeraPad, CeraPlas, CSMP, CTVS, DeltaCap, DigiSiMic, ExoCore, FilterCap, FormFit, LeaXield, MiniBlue, MiniCell, MKD, MKK, MotorCap, PCC, PhaseCap, PhaseCube, PhaseMod, PhiCap, PowerHap, PQSine, PQvar, SIFERRIT, SIFI, SIKOREL, SilverCap, SIMDAD, SiMic, SIMID, SineFormer, SIOV, ThermoFuse, WindCap are **trademarks registered or pending** in Europe and in other countries. Further information will be found on the Internet at www.tdk-electronics.tdk.com/trademarks.

Release 2018-10