

ASMT-Rx45-xxxxx

0.45-mm Leadframe-Based Surface Mount ChipLED

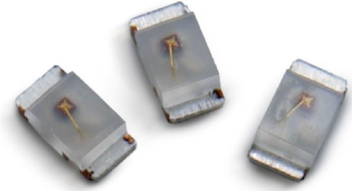

Description

The ultra-thin ASMT-Rx45 ChipLEDs from Broadcom[®] were developed based on the industrial standard ChipLED 0603 platform, which requires less board space. These ChipLEDs provide a wide viewing angle of 130 degrees to improve visibility in bright sunlight.

In addition to the high-brightness and compact size, Broadcom's ASMT-Rx45 ChipLEDs provide two significant advantages in the production environment: They can be easily soldered using the IR solder reflow process, and the package is qualified to a Joint Electronic Device Engineering Council (JEDEC) moisture sensitive level (MSL) rating of 2a. For manufacturers, this rating means that these ChipLEDs can be kept in the open air (30°C, 60% relative humidity) for up to four weeks after being removed from its sealed package without the need to remove absorbed moisture.

Broadcom's ultra-thin Leadframe ChipLED is available in red, orange, yellow green, and amber colors. The ASMT-Rx45 series is ideal for use by lighting designers developing backlighting for dashboards and entertainment consoles in automobiles, backlighting of industrial switches and buttons, and small pixel indoor signs.

Features

- Industrial 0603 platform – 1.6 mm × 0.8 mm × 0.45 mm
- Automotive qualified
- Super wide 145° viewing angle
- JEDEC MSL 2a.
- Robust operating temperature from –40°C to +100°C
- Junction temperature $T_J = 110^\circ\text{C}$
- Available in 4000 parts per reel
- RoHS and IR reflow compatible

Applications

- Interior automotive
 - Navigation backlighting
 - Audio panel backlighting
 - Push button backlighting
- Office automation, home appliances, and industrial equipment
 - Front panel backlighting
 - Push button backlighting
 - LCD backlighting
 - Switch backlighting
 - Navigation backlighting

CAUTION! ASMT-Rx45 LEDs are Class 1C ESD sensitive per JESD22-A114C.01. Observe appropriate precautions during handling and processing. Refer to Application Note AN-1142 for additional details.

Package Dimensions

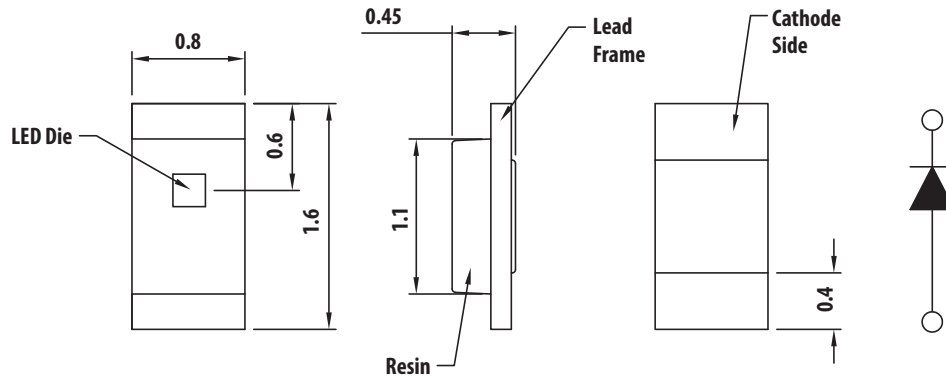

NOTE:

1. All dimensions are in millimeters.
2. Tolerance is ± 0.1 mm unless otherwise specified.

Device Selection Guide

Part Number	Min. I_v (mcd)	Typ. I_v (mcd)	Test Current (mA)	Colors	Dice Technology	Package Description
ASMT-RR45-AQ902	90.0	120.0	20	Red	AllnGaP	Untinted, Diffused
ASMT-RJ45-AQ502	71.5	130.0	20	Orange	AllnGaP	Untinted, Diffused
ASMT-RF45-AN002	28.0	60.0	20	Yellow Green	AllnGaP	Untinted, Diffused
ASMT-RA45-AP932	57.0	90.0	20	Amber	AllnGaP	Untinted, Diffused
ASMT-RH45-AQ502	71.5	110.0	20	Red Orange	AllnGaP	Untinted, Diffused

NOTE:

1. The luminous intensity, I_v , is measured at the peak of the spatial radiation pattern, which may not be aligned with the mechanical axis of the LED package.
2. Tolerance: $\pm 15\%$.

Part Numbering System

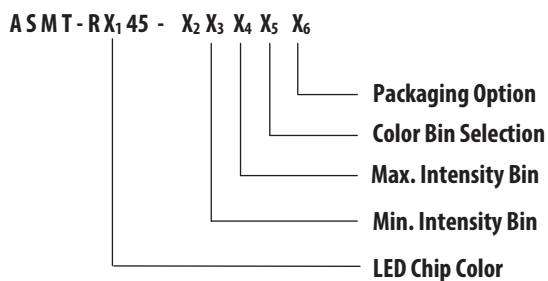

Absolute Maximum Ratings at $T_A = 25^\circ\text{C}$

Parameter	ASMT-Rx45	Units
DC Forward Current ^a	20	mA
Power Dissipation	48	mW
Reverse Voltage ($I_R = 100\text{ mA}$)	5	V
LED Junction Temperature	110	$^\circ\text{C}$
Operating Temperature Range	-40 to +100	$^\circ\text{C}$
Storage Temperature Range	-40 to +100	$^\circ\text{C}$

a. Applies when a single LED is illuminated.

Electrical Characteristics at $T_A = 25^\circ\text{C}$

Part Number	Forward Voltage VF (Volts) ^a @ $I_F = 20\text{ mA}$			Reverse Breakdown V_R (Volts) @ $I_R = 100\text{ }\mu\text{A}$	Thermal Resistance $R_{\theta_{J-PIN}}$ ($^\circ\text{C/W}$)
	Min.	Typ.	Max.	Min.	Typ.
ASMT-Rx45-Axxxx	1.6	2.0	2.4	5	246

a. VF tolerance: $\pm 0.1\text{V}$.

Optical Characteristics at $T_A = 25^\circ\text{C}$

Part Number	Color	Peak Wavelength λ_{peak} (nm)	Dominant Wavelength λ_d^a (nm)	Viewing Angle $2\theta_{1/2}^b$ (Degrees)
		Typical	Typical	Typical
ASMT-RR45-AQ902	Red	636	622	145
ASMT-RJ45-AQ502	Orange	612	605	145
ASMT-RF45-AN002	Yellow Green	574	573	145
ASMT-RA45-AP932	Amber	593	591	145
ASMT-RH45-AQ502	Red Orange	621	615	145

a. The dominant wavelength, λ_d , is derived from the CIE Chromaticity Diagram and represents the perceived color of the device.

b. $\theta_{1/2}$ is the off-axis angle where the luminous intensity is $\frac{1}{2}$ the peak intensity.

Figure 1: Relative Intensity vs. Wavelength

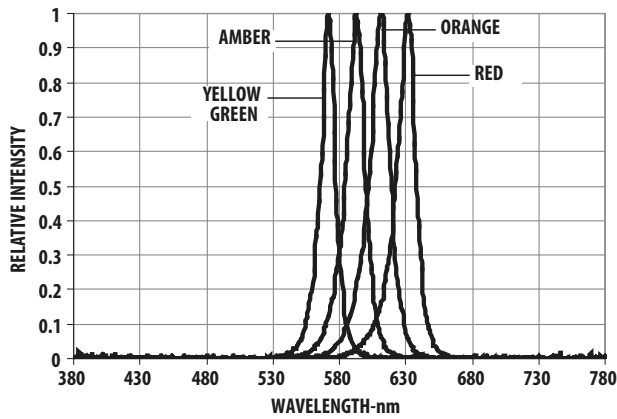

Figure 2: Forward Current vs. Forward Voltage

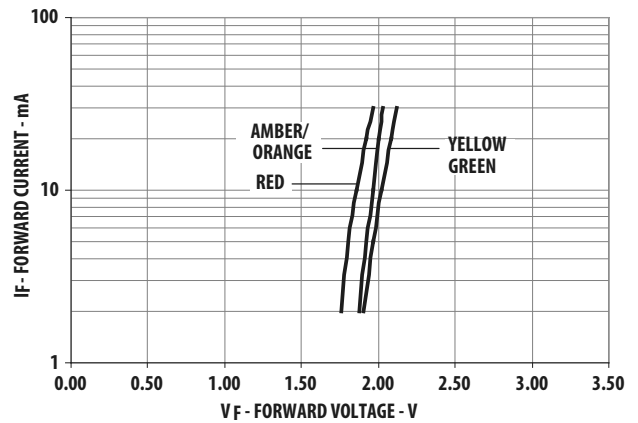

Figure 3: Luminous Intensity vs. Forward Current

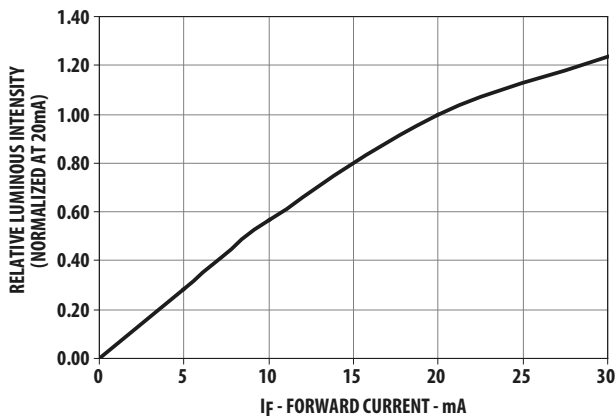

Figure 4: Maximum Forward Current vs. Ambient Temperature. Derated based on $T_{JMAX} = 110^{\circ}C$, $R_{\theta JA} = 465^{\circ}C/W$.

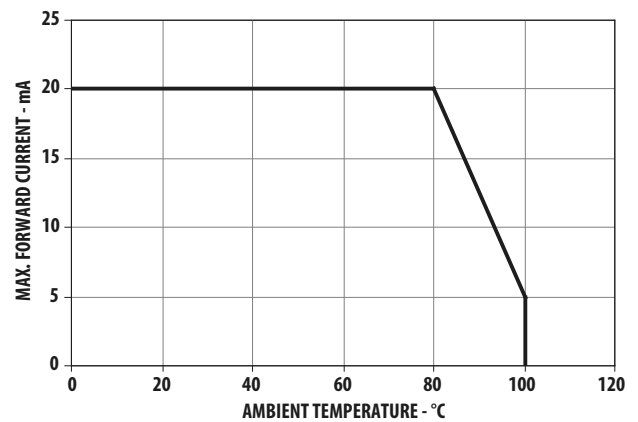

Figure 5: Radiation Pattern

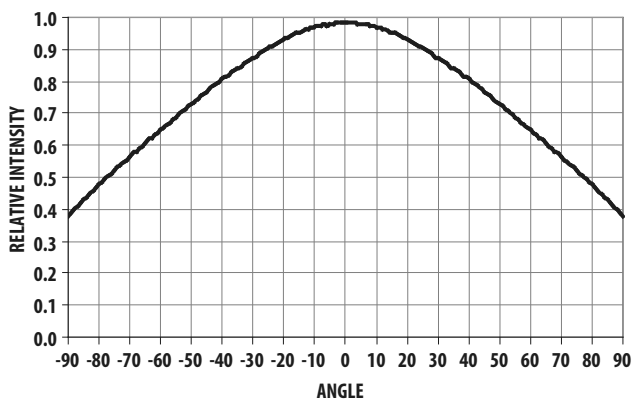
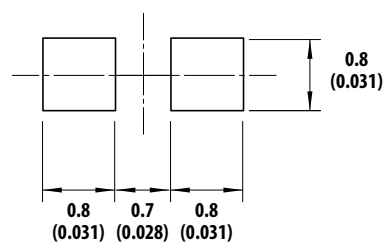

Figure 6: Recommended Soldering Land Pattern



1. All dimensions are in millimeters (inches).
2. Tolerance is ± 0.1 mm (± 0.004 in.) unless otherwise specified.

Figure 7: Recommended Reflow Soldering Profile

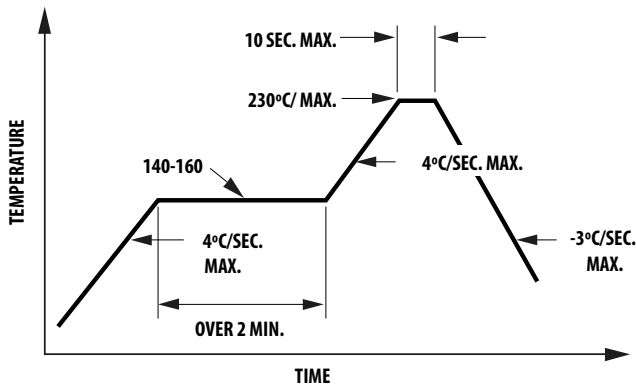
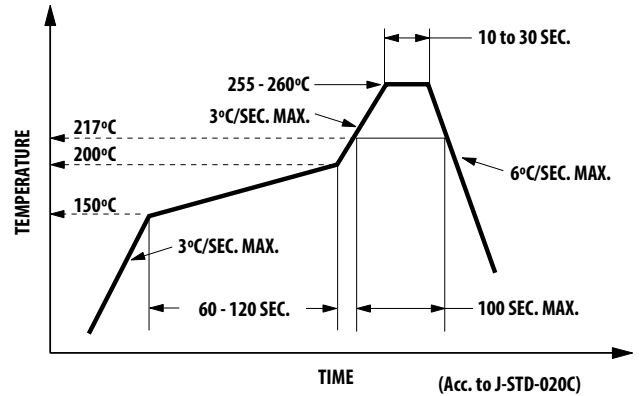

Figure 8: Recommended Pb-Free Reflow Soldering Profile



NOTE: For detailed information on reflow soldering of Broadcom surface mount LEDs, refer to Broadcom Application Note AN1060, *Surface Mounting SMT LED Indicator Components*.

Figure 9: Tape Dimensions

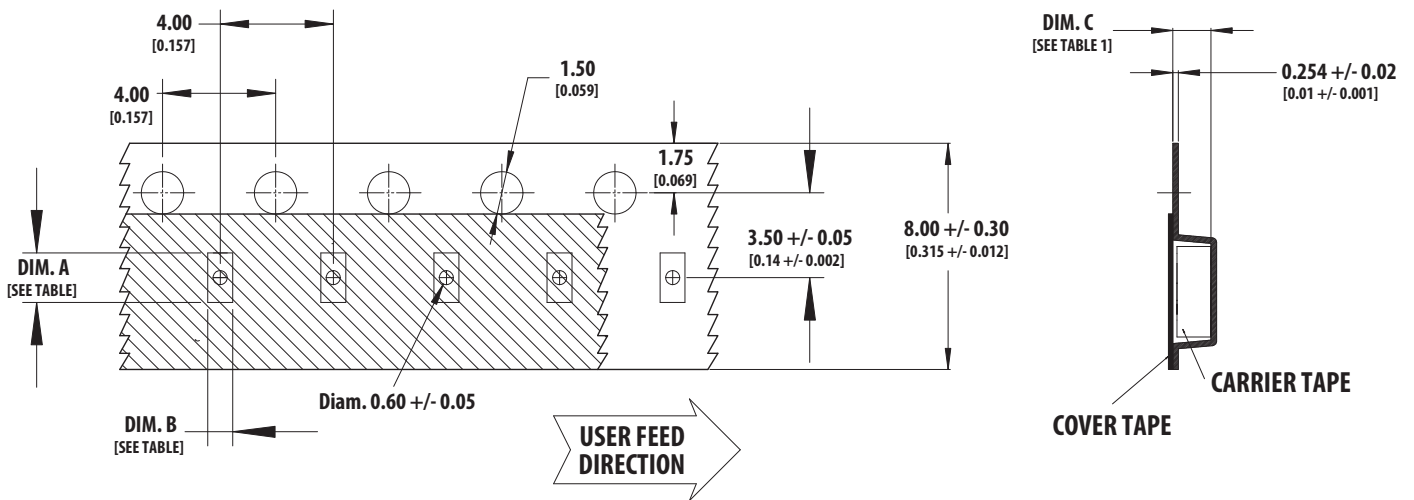
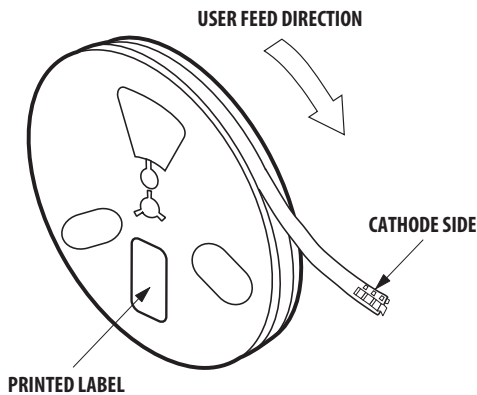

Figure 10: Reeling Orientation



Intensity Bin Select (X_3X_4)

Individual reel contains parts from one-half bin only.

X_3	Min I_V Bin
-------	---------------

X_4	Full Distribution
0	Full Distribution
2	2 half bins starting from X31
3	3 half bins starting from X31
4	4 half bins starting from X31
5	5 half bins starting from X31
6	2 half bins starting from X32
7	3 half bins starting from X32
8	4 half bins starting from X32
9	5 half bins starting from X32

Light Intensity (I_V) Bin Limits

Bin ID	Intensity (mcd)	
	Min.	Max
A1	0.11	0.14
A2	0.14	0.18
B1	0.18	0.23
B2	0.23	0.29
C1	0.29	0.36
C2	0.36	0.45
D1	0.45	0.57
D2	0.57	0.72
E1	0.72	0.90
E2	0.90	1.10
F1	1.10	1.41
F2	1.41	1.80
G1	1.80	2.24
G2	2.24	2.80
H1	2.80	3.55
H2	3.55	4.50
J1	4.50	5.70
J2	5.70	7.20
K1	7.20	9.00
K2	9.00	11.20
L1	11.20	14.20
L2	14.20	18.00
M1	18.00	22.50
M2	22.50	28.00
N1	28.00	36.00
N2	36.00	45.00
P1	45.00	57.00
P2	57.00	71.50
Q1	71.50	90.00
Q2	90.00	113.00
R1	113.00	142.00
R2	142.00	180.00
S1	180.00	227.00
S2	227.00	285.00

Tolerance: $\pm 15\%$.

Color Bin Select (X₅)

Individual reel contains parts from one full bin only.

X ₅	
0	Full Distribution
Z	A and B only
Y	B and C only
W	C and D only
V	D and E only
U	E and F only
T	F and G only
S	G and H only
Q	A, B and C only
P	B, C and D only
N	C, D and E only
M	D, E and F only
L	E, F and G only
K	F, G and H only
J	Special Color Bin
1	A, B, C and D only
2	E, F, G and H only
3	B, C, D and E only
4	C, D, E and F only
5	A, B, C, D and E only
6	B, C, D, E, and F only

Packaging Option (X₆)

Option	Test Current	Package Type	Reel Size
2	20 mA	Top Mount	7 Inch
H	2 mA	Top Mount	7 Inch
K	5 mA	Top Mount	7 Inch

Forward Voltage (V_F) Bin Limits

Bin ID	Forward Voltage (V)	
	Min.	Max.
1	1.60	1.80
2	1.80	2.00
3	2.00	2.20
4	2.20	2.40

Tolerance: ±0.1V.

Color Bin Limits

Yellow Green Color Bin

Bin ID	Dominant Wavelength (nm)	
	Min.	Max.
E	564.5	567.5
F	567.5	570.5
G	570.5	573.5
H	573.5	576.5

Yellow/Amber Color Bin

Bin ID	Dominant Wavelength (nm)	
	Min.	Max.
A	582.0	584.5
B	584.5	587.0
C	587.0	589.5
D	589.5	592.0
E	592.0	594.5
F	594.5	597.0

Orange Color Bin

Bin ID	Dominant Wavelength (nm)	
	Min.	Max.
A	597.0	600.0
B	600.0	603.0
C	603.0	606.0
D	606.0	609.0
E	609.0	612.0

Red Color Bin

Bin ID	Dominant Wavelength (nm)	
	Min.	Max.
Full Distribution	620.0	635.0

Red Orange Color Bin

Bin ID	Dominant Wavelength (nm)	
	Min.	Max.
A	610.0	615.0
B	615.0	620.0

Tolerance: ±1 nm.

Moisture Sensitivity

This product is qualified as Moisture Sensitive Level 2a per JEDEC J-STD-020. Take precautions when handling this moisture sensitive product to ensure the reliability of the product. Refer to Broadcom Application Note AN5305, *Handling of Moisture Sensitive Surface Mount Devices* for details.

Storage Before Use

- An unopen moisture barrier bag (MBB) can be stored at < 40°C/90% RH for 12 months. If the actual shelf life has exceeded 12 months and the humidity indicator card (HIC) indicates that baking is not required, then it is safe to reflow the LEDs per the original MSL rating.
- Do not open the MBB prior to assembly (for example, for IQC).

Control after Opening the MBB

- Read the HIC when opening the MBB.
- Keep the LEDs at < 30°C/60% RH at all times and for all high-temperature related processes, including soldering, curing, or rework that must be completed within 672 hours.

Control for the Unfinished Reel

- Store unused LEDs in a sealed MBB with desiccant or desiccator at < 5%RH.

Control of Assembled Boards

- If the PCB soldered with the LEDs is to be subjected to other high-temperature processes, store the PCB in a sealed MBB with desiccant or desiccator at <5% RH to ensure that no LEDs have exceeded their floor life of 672 hours.

Baking Is Required for the Following Conditions

- "10%" or "15%" on the HIC turns pink.
- The LEDs are exposed to conditions of > 30°C/60% RH at any time.
- The LEDs' floor life exceeded 672 hours.

The recommended baking condition is 60°C ± 5°C for 20 hours.

Broadcom, the pulse logo, Connecting everything, Avago Technologies, Avago, and the A logo are among the trademarks of Broadcom and/or its affiliates in the United States, certain other countries, and/or the EU.

Copyright © 2014–2019 Broadcom. All Rights Reserved.

The term “Broadcom” refers to Broadcom Inc. and/or its subsidiaries. For more information, please visit www.broadcom.com.

Broadcom reserves the right to make changes without further notice to any products or data herein to improve reliability, function, or design. Information furnished by Broadcom is believed to be accurate and reliable. However, Broadcom does not assume any liability arising out of the application or use of this information, nor the application or use of any product or circuit described herein, neither does it convey any license under its patent rights nor the rights of others.



Mouser Electronics

Authorized Distributor

Click to View Pricing, Inventory, Delivery & Lifecycle Information:

[Broadcom Limited:](#)

[ASMT-RA45-AP932](#) [ASMT-RF45-AN002](#) [ASMT-RH45-AQ502](#) [ASMT-RR45-AQ902](#) [ASMT-RJ45-AQ502](#)