

ADR4520/ADR4525/ADR4530/ADR4533/ ADR4540/ADR4550

Ultralow Noise, High Accuracy Voltage References

FEATURES

- ▶ Maximum temperature coefficient (TCV_{OUT}):
 - ▶ 0.8 ppm/°C (D grade 0°C to 70°C)
 - ▶ 1 ppm/°C (C grade 0°C to 70°C)
 - ▶ 2 ppm/°C (B grade -40°C to +125°C)
 - ▶ 4 ppm/°C (A grade -40°C to +125°C)
- ▶ Output noise (0.1 Hz to 10 Hz):
 - ▶ 1 μ V p-p at V_{OUT} of 2.048 V typical
- ▶ Initial output voltage error:
 - ▶ B, C, D grade: $\pm 0.02\%$ (maximum)
- ▶ Input voltage range: 3 V to 15 V
- ▶ Operating temperature:
 - ▶ A grade and B grade: -40°C to +125°C
 - ▶ C grade and D grade: 0°C to +70°C
- ▶ Output current: +10 mA source/-10 mA sink
- ▶ Low quiescent current: 950 μ A (maximum)
- ▶ Low dropout voltage: 300 mV at 2 mA ($V_{OUT} \geq 3$ V)
- ▶ 8-lead SOIC and LCC packages
- ▶ AEC-Q100 qualified for automotive applications
- ▶ Long-term drift: 8 ppm typical at 4500 hours

APPLICATIONS

- ▶ Precision data acquisition systems
- ▶ High resolution data converters
- ▶ High precision measurement devices
- ▶ Industrial instrumentation
- ▶ Medical devices
- ▶ Automotive battery monitoring

GENERAL DESCRIPTION

The ADR4520/ADR4525/ADR4530/ADR4533/ADR4540/ADR4550 devices are high precision, low power, low noise voltage references featuring $\pm 0.02\%$ B, C, and D grade maximum initial error, excellent temperature stability, and low output noise.

This family of voltage references uses an innovative core topology to achieve high accuracy while offering industry-leading temperature stability and noise performance. The low, thermally induced output voltage hysteresis and low long-term output voltage drift of the devices also improve system accuracy over time and temperature variations.

A maximum operating current of 950 μ A and a maximum low dropout voltage of 300 mV allow the devices to function very well in portable equipment.

Rev. E

PIN CONFIGURATIONS

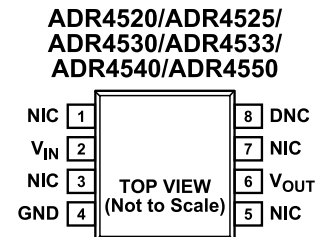

NOTES

1. NC = NO CONNECT.
THIS PIN IS NOT CONNECTED INTERNALLY.
2. DNC = DO NOT CONNECT. DO NOT CONNECT TO THIS PIN.

001

Figure 1. 8-Lead SOIC Pin Configuration

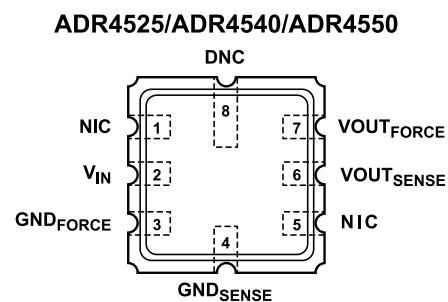

NOTES

1. NIC = NO INTERNAL CONNECTION.
THIS PIN IS NOT CONNECTED INTERNALLY.
2. DNC = DO NOT CONNECT. DO NOT CONNECT TO THIS PIN.

057

Figure 2. 8-Lead LCC Pin Configuration

The ADR4520/ADR4525/ADR4530/ADR4533/ADR4540/ADR4550 series of references are each provided in an 8-lead SOIC and are available in a wide range of output voltages, all of which are specified over the extended industrial temperature range of -40°C to +125°C.

The ADR4525, ADR4540, and ADR4550 are also available in D, which are in 8 lead LCC package, and C grade with a temperature range of 0°C to 70°C. The ADR4525W, available in an 8-lead SOIC package, is qualified for automotive applications.

TABLE OF CONTENTS

Features.....	1	ADR4533.....	22
Applications.....	1	ADR4540.....	25
Pin Configurations.....	1	ADR4550.....	29
General Description.....	1	Terminology.....	33
Specifications.....	3	Applications Information.....	35
ADR4520 Electrical Characteristics.....	3	Basic Voltage Reference Connection.....	35
ADR4525 Electrical Characteristics.....	3	Input and Output Capacitors.....	35
ADR4530 Electrical Characteristics.....	5	Location of Reference in System.....	35
ADR4533 Electrical Characteristics.....	6	Power Dissipation.....	35
ADR4540 Electrical Characteristics.....	6	Sample Applications.....	35
ADR4550 Electrical Characteristics.....	8	Long-Term Drift	36
Absolute Maximum Ratings.....	10	Thermal Hysteresis.....	37
Thermal Resistance.....	10	Humidity Sensitivity.....	38
ESD Caution.....	10	Power Cycle Hysteresis.....	39
Pin Configurations and Function Descriptions.....	11	Selection Guide and Voltage Reference	
Typical Performance Characteristics.....	12	Choices.....	39
ADR4520.....	12	Outline Dimensions.....	40
ADR4525.....	15	Ordering Guide.....	40
ADR4530.....	19	Automotive Products.....	41

REVISION HISTORY

5/2023—Rev. D to Rev. E

Changes to Figure 2.....	1
Changes to Figure 4 and Table 10.....	11
Changes to Figure 31 and Figure 34.....	17
Changes to Figure 36 and Figure 38.....	18
Change to Figure 61.....	23
Changes to Figure 65 and Figure 67.....	25
Changes to Figure 78 and Figure 81.....	27
Changes to Figure 83 and Figure 85.....	28
Changes to Figure 86 and Figure 88.....	29
Changes to Figure 99 and Figure 102.....	31
Changes to Figure 104 and Figure 106.....	32
Added Selection Guide and Voltage Reference Choices Section.....	39
Moved Table 12 and Table 13.....	39

SPECIFICATIONS

ADR4520 ELECTRICAL CHARACTERISTICS

Unless otherwise noted, supply voltage (V_{IN}) = 3 V to 15 V, I_L = 0 mA, T_A = 25°C.

Table 1.

Parameter	Symbol	Test Conditions/Comments	Min	Typ	Max	Unit
OUTPUT VOLTAGE	V_{OUT}			2.048		V
INITIAL OUTPUT VOLTAGE ERROR	V_{OUT_ERR}					
B Grade					±0.02	%
					410	μV
A Grade					±0.04	%
					820	μV
SOLDER HEAT RESISTANCE SHIFT				±0.02		%
TEMPERATURE COEFFICIENT	TCV_{OUT}	See Terminology section				
B Grade		-40°C ≤ T_A ≤ +125°C (box method)			2	ppm/°C
		-40°C ≤ T_A ≤ +125°C (bowtie method)			4	ppm/°C
A Grade		-40°C ≤ T_A ≤ +125°C (box method)			4	ppm/°C
		-40°C ≤ T_A ≤ +125°C (bowtie method)			8	ppm/°C
LINE REGULATION	$\Delta V_{OUT}/\Delta V_{IN}$	-40°C ≤ T_A ≤ +125°C		1	10	ppm/V
LOAD REGULATION	$\Delta V_{OUT}/\Delta I_L$	I_L = 0 mA to +10 mA source, -40°C ≤ T_A ≤ +125°C		30	80	ppm/mA
		I_L = 0 mA to -10 mA sink, -40°C ≤ T_A ≤ +125°C		100	120	ppm/mA
QUIESCENT CURRENT	I_Q	-40°C ≤ T_A ≤ +125°C, no load		700	950	μA
DROPOUT VOLTAGE	V_{DO}	-40°C ≤ T_A ≤ +125°C, no load			1	V
		-40°C ≤ T_A ≤ +125°C, I_L = 2 mA			1	V
RIPPLE REJECTION RATIO	RRR	Input frequency (f_{IN}) = 1 kHz		90		dB
OUTPUT CURRENT CAPACITY	I_L					
Sinking					-8	mA
Sourcing					10	mA
OUTPUT VOLTAGE NOISE	e_{NP-p}	0.1 Hz to 10.0 Hz		1.0		μV p-p
OUTPUT VOLTAGE NOISE DENSITY	e_N	1 kHz		35.8		nV/√Hz
OUTPUT VOLTAGE HYSTERESIS	ΔV_{OUT_HYS}	T_A = temperature cycled from				
		+25°C to +125°C to -40°C to +25°C (full cycle)			-13	ppm
		25°C to 125°C to 25°C (half cycle)			-97	ppm
		25°C to 70°C to 0°C to 25°C (full cycle)			-8	ppm
		25°C to 70°C to 25°C (half cycle)			-17	ppm
LONG-TERM DRIFT	ΔV_{OUT_LTD}	T_A = 25°C				
		250 hours (early life drift)		19		ppm
		1000 hours		25		ppm
		4500 hours		51		ppm
TURN-ON SETTLING TIME	t_R	Output capacitor (C_{OUT}) = 1 μF, input capacitor (C_{IN}) = 0.1 μF, load resistance (R_{LOAD}) = 1 kΩ		90		μs
LOAD CAPACITANCE			1		100	μF

ADR4525 ELECTRICAL CHARACTERISTICS

Unless otherwise noted, V_{IN} = 3 V to 15 V, I_L = 0 mA, T_A = 25°C.

SPECIFICATIONS

Table 2.

Parameter	Symbol	Test Conditions/Comments	Min	Typ	Max	Unit
OUTPUT VOLTAGE	V_{OUT}			2.500		V
INITIAL OUTPUT VOLTAGE ERROR	V_{OUT_ERR}					
B, C, D Grade					±0.02	%
					500	µV
A Grade					±0.04	%
					1	mV
SOLDER HEAT RESISTANCE SHIFT						
A, B, C, D Grade				±0.02		%
TEMPERATURE COEFFICIENT	TCV_{OUT}	See Terminology section				
D Grade		$0^{\circ}\text{C} \leq T_A \leq 70^{\circ}\text{C}$ (box method)			0.8	ppm/°C
		$0^{\circ}\text{C} \leq T_A \leq 70^{\circ}\text{C}$ (bowtie method)			1.6	ppm/°C
C Grade		$0^{\circ}\text{C} \leq T_A \leq 70^{\circ}\text{C}$ (box method)			1	ppm/°C
		$0^{\circ}\text{C} \leq T_A \leq 70^{\circ}\text{C}$ (bowtie method)			2	ppm/°C
B Grade		$-40^{\circ}\text{C} \leq T_A \leq +125^{\circ}\text{C}$ (box method)			2	ppm/°C
		$-40^{\circ}\text{C} \leq T_A \leq +125^{\circ}\text{C}$ (bowtie method)			4	ppm/°C
A Grade		$-40^{\circ}\text{C} \leq T_A \leq +125^{\circ}\text{C}$ (box method)			4	ppm/°C
		$-40^{\circ}\text{C} \leq T_A \leq +125^{\circ}\text{C}$ (bowtie method)			8	ppm/°C
LINE REGULATION	$\Delta V_{OUT}/\Delta V_{IN}$	$-40^{\circ}\text{C} \leq T_A \leq +125^{\circ}\text{C}$		1	10	ppm/V
LOAD REGULATION	$\Delta V_{OUT}/\Delta I_L$					
A, B, C Grade		$I_L = 0\text{ mA to }+10\text{ mA source, }-40^{\circ}\text{C} \leq T_A \leq +125^{\circ}\text{C}$		30	80	ppm/mA
		$I_L = 0\text{ mA to }-10\text{ mA sink, }-40^{\circ}\text{C} \leq T_A \leq +125^{\circ}\text{C}$		60	120	ppm/mA
D Grade		$I_L = 0\text{ mA to }+10\text{ mA source, }0^{\circ}\text{C} \leq T_A \leq +70^{\circ}\text{C}$		35	45	ppm/mA
		$I_L = 0\text{ mA to }-10\text{ mA sink, }0^{\circ}\text{C} \leq T_A \leq +70^{\circ}\text{C}$		4	9	ppm/mA
QUIESCENT CURRENT	I_Q	$-40^{\circ}\text{C} \leq T_A \leq +125^{\circ}\text{C}$, no load		700	950	µA
DROPOUT VOLTAGE	V_{DO}	$-40^{\circ}\text{C} \leq T_A \leq +125^{\circ}\text{C}$, no load			500	mV
		$-40^{\circ}\text{C} \leq T_A \leq +125^{\circ}\text{C}$, $I_L = 2\text{ mA}$			500	mV
RIPPLE REJECTION RATIO	RRR	$f_{IN} = 1\text{ kHz}$		90		dB
OUTPUT CURRENT CAPACITY	I_L					
Sinking					-10	mA
Sourcing					10	mA
OUTPUT VOLTAGE NOISE	e_{Np-p}	0.1 Hz to 10.0 Hz		1.25		µV p-p
OUTPUT VOLTAGE NOISE DENSITY	e_N	1 kHz		41.3		nV/√Hz
OUTPUT VOLTAGE HYSTERESIS	ΔV_{OUT_HYS}	$T_A =$ temperature cycled from				
A, B, C Grade		+25°C to +125°C to -40°C to +25°C (full cycle)		-13		ppm
		25°C to 125°C to 25°C (half cycle)		-97		ppm
		25°C to 70°C to 0°C to 25°C (full cycle)		-8		ppm
		25°C to 70°C to 25°C (half cycle)		-17		ppm
D Grade		25°C to 70°C to 0°C to 25°C (full cycle)		1		ppm
		25°C to 70°C to 25°C (half cycle)		5		ppm
LONG-TERM DRIFT	ΔV_{OUT_LTD}	$T_A = 25^{\circ}\text{C}$				
A, B, C Grade		250 hours (early life drift)		19		ppm
		1000 hours		25		ppm
		4500 hours		51		ppm
D Grade		250 hours (early life drift)		3		ppm
		1000 hours		5		ppm
		4500 hours		8		ppm

SPECIFICATIONS

Table 2. (Continued)

Parameter	Symbol	Test Conditions/Comments	Min	Typ	Max	Unit
TURN-ON SETTLING TIME	t_R	$C_{OUT} = 1 \mu\text{F}$, $C_{IN} = 0.1 \mu\text{F}$, $R_{LOAD} = 1 \text{ k}\Omega$		125		μs
LOAD CAPACITANCE			1		100	μF

ADR4530 ELECTRICAL CHARACTERISTICS

Unless otherwise noted, $V_{IN} = 3.1 \text{ V}$ to 15 V , $I_L = 0 \text{ mA}$, $T_A = 25^\circ\text{C}$.

Table 3.

Parameter	Symbol	Test Conditions/Comments	Min	Typ	Max	Unit
OUTPUT VOLTAGE	V_{OUT}			3.000		V
INITIAL OUTPUT VOLTAGE ERROR	V_{OUT_ERR}					
B Grade					± 0.02	%
					600	μV
A Grade					± 0.04	%
					1.2	mV
SOLDER HEAT RESISTANCE SHIFT				± 0.02		%
TEMPERATURE COEFFICIENT	TCV_{OUT}	See Terminology section				
B Grade		$-40^\circ\text{C} \leq T_A \leq +125^\circ\text{C}$ (box method)			2	ppm/ $^\circ\text{C}$
		$-40^\circ\text{C} \leq T_A \leq +125^\circ\text{C}$ (bowtie method)			4	ppm/ $^\circ\text{C}$
A Grade		$-40^\circ\text{C} \leq T_A \leq +125^\circ\text{C}$ (box method)			4	ppm/ $^\circ\text{C}$
		$-40^\circ\text{C} \leq T_A \leq +125^\circ\text{C}$ (bowtie method)			8	ppm/ $^\circ\text{C}$
LINE REGULATION	$\Delta V_{OUT}/\Delta V_{IN}$	$-40^\circ\text{C} \leq T_A \leq +125^\circ\text{C}$		1	10	ppm/V
LOAD REGULATION	$\Delta V_{OUT}/\Delta I_L$	$I_L = 0 \text{ mA}$ to $+10 \text{ mA}$ source, $-40^\circ\text{C} \leq T_A \leq +125^\circ\text{C}$ $I_L = 0 \text{ mA}$ to -10 mA sink, $-40^\circ\text{C} \leq T_A \leq +125^\circ\text{C}$		30	80	ppm/mA
				60	120	ppm/mA
QUIESCENT CURRENT	I_Q	$-40^\circ\text{C} \leq T_A \leq +125^\circ\text{C}$, no load		700	950	μA
DROPOUT VOLTAGE	V_{DO}	$-40^\circ\text{C} \leq T_A \leq +125^\circ\text{C}$, no load $-40^\circ\text{C} \leq T_A \leq +125^\circ\text{C}$, $I_L = 2 \text{ mA}$			100	mV
					300	mV
RIPPLE REJECTION RATIO	RRR	$f_{IN} = 1 \text{ kHz}$		90		dB
OUTPUT CURRENT CAPACITY	I_L					
Sinking					-10	mA
Sourcing					10	mA
OUTPUT VOLTAGE NOISE	e_{Np-p}	0.1 Hz to 10.0 Hz		1.6		$\mu\text{V p-p}$
OUTPUT VOLTAGE NOISE DENSITY	e_N	1 kHz		60		nV/ $\sqrt{\text{Hz}}$
OUTPUT VOLTAGE HYSTERESIS	ΔV_{OUT_HYS}	$T_A =$ temperature cycled from $+25^\circ\text{C}$ to $+125^\circ\text{C}$ to -40°C to $+25^\circ\text{C}$ (full cycle) 25°C to 125°C to 25°C (half cycle) 25°C to 70°C to 0°C to 25°C (full cycle) 25°C to 70°C to 25°C (half cycle)		-13		ppm
				-97		ppm
				-8		ppm
				-17		ppm
LONG-TERM DRIFT	ΔV_{OUT_LTD}	$T_A = 25^\circ\text{C}$ 250 hours (early life drift) 1000 hours 4500 hours		19		ppm
				25		ppm
				51		ppm
TURN-ON SETTLING TIME	t_R	$C_{OUT} = 0.1 \mu\text{F}$, $C_{IN} = 0.1 \mu\text{F}$, $R_{LOAD} = 1 \text{ k}\Omega$		130		μs
LOAD CAPACITANCE			0.1		100	μF

SPECIFICATIONS

ADR4533 ELECTRICAL CHARACTERISTICS

Unless otherwise noted, $V_{IN} = 3.4\text{ V to }15\text{ V}$, $I_L = 0\text{ mA}$, $T_A = 25^\circ\text{C}$.

Table 4.

Parameter	Symbol	Test Conditions/Comments	Min	Typ	Max	Unit
OUTPUT VOLTAGE	V_{OUT}			3.300		V
INITIAL OUTPUT VOLTAGE ERROR	V_{OUT_ERR}					
B Grade					±0.02	%
A Grade					660	μV
					±0.04	%
					1.32	mV
SOLDER HEAT RESISTANCE SHIFT				±0.02		%
TEMPERATURE COEFFICIENT	TCV_{OUT}	See Terminology section				
B Grade		-40°C ≤ T_A ≤ +125°C (box method)			2	ppm/°C
		-40°C ≤ T_A ≤ +125°C (bowtie method)			4	ppm/°C
A Grade		-40°C ≤ T_A ≤ +125°C (box method)			4	ppm/°C
		-40°C ≤ T_A ≤ +125°C (bowtie method)			8	ppm/°C
LINE REGULATION	$\Delta V_{OUT}/\Delta V_{IN}$	-40°C ≤ T_A ≤ +125°C		1	10	ppm/V
LOAD REGULATION	$\Delta V_{OUT}/\Delta I_L$	$I_L = 0\text{ mA to }+10\text{ mA source, }-40^\circ\text{C} \leq T_A \leq +125^\circ\text{C}$ $I_L = 0\text{ mA to }-10\text{ mA sink, }-40^\circ\text{C} \leq T_A \leq +125^\circ\text{C}$		30	80	ppm/mA
				60	120	ppm/mA
QUIESCENT CURRENT	I_Q	-40°C ≤ T_A ≤ +125°C, no load		700	950	μA
DROPOUT VOLTAGE	V_{DO}	-40°C ≤ T_A ≤ +125°C, no load			100	mV
		-40°C ≤ T_A ≤ +125°C, $I_L = 2\text{ mA}$			300	mV
RIPPLE REJECTION RATIO	RRR	$f_{IN} = 1\text{ kHz}$		90		dB
OUTPUT CURRENT CAPACITY	I_L					
Sinking					-10	mA
Sourcing					10	mA
OUTPUT VOLTAGE NOISE	e_{Np-p}	0.1 Hz to 10.0 Hz		2.1		μV p-p
OUTPUT VOLTAGE NOISE DENSITY	e_N	1 kHz		64.2		nV/√Hz
OUTPUT VOLTAGE HYSTERESIS	ΔV_{OUT_HYS}	$T_A = \text{temperature cycled from}$ +25°C to +125°C to -40°C to +25°C (full cycle) 25°C to 125°C to 25°C (half cycle) 25°C to 70°C to 0°C to 25°C (full cycle) 25°C to 70°C to 25°C (half cycle)		-13		ppm
				-97		ppm
				-8		ppm
				-17		ppm
LONG-TERM DRIFT	ΔV_{OUT_LTD}	$T_A = 25^\circ\text{C}$ 250 hours (early life drift) 1000 hours 4500 hours		19		ppm
				25		ppm
				51		ppm
TURN-ON SETTLING TIME	t_R	$C_{OUT} = 0.1\text{ }\mu\text{F}$, $C_{IN} = 0.1\text{ }\mu\text{F}$, $R_{LOAD} = 1\text{ k}\Omega$		135		μs
LOAD CAPACITANCE			0.1		100	μF

ADR4540 ELECTRICAL CHARACTERISTICS

Unless otherwise noted, $V_{IN} = 4.2\text{ V to }15\text{ V}$, $I_L = 0\text{ mA}$, $T_A = 25^\circ\text{C}$.

Table 5.

Parameter	Symbol	Test Conditions/Comments	Min	Typ	Max	Unit
OUTPUT VOLTAGE	V_{OUT}			4.096		V

SPECIFICATIONS

Table 5. (Continued)

Parameter	Symbol	Test Conditions/Comments	Min	Typ	Max	Unit
INITIAL OUTPUT VOLTAGE ERROR B, C, D Grade	V_{OUT_ERR}				±0.02 820	% μV
A Grade					±0.04 1.64	% mV
SOLDER HEAT RESISTANCE SHIFT A, B, C, D Grade				±0.02		%
TEMPERATURE COEFFICIENT	TCV_{OUT}	See Terminology section				
D Grade		0°C ≤ T _A ≤ +70°C (box method)			0.8	ppm/°C
C Grade		0°C ≤ T _A ≤ +70°C (bowtie method)			1.6	ppm/°C
B Grade		0°C ≤ T _A ≤ +70°C (box method)			1	ppm/°C
A Grade		0°C ≤ T _A ≤ +70°C (bowtie method)			2	ppm/°C
		-40°C ≤ T _A ≤ +125°C (box method)			2	ppm/°C
		-40°C ≤ T _A ≤ +125°C (bowtie method)			4	ppm/°C
		-40°C ≤ T _A ≤ +125°C (box method)			4	ppm/°C
		-40°C ≤ T _A ≤ +125°C (bowtie method)			8	ppm/°C
LINE REGULATION	$\Delta V_{OUT}/\Delta V_{IN}$	-40°C ≤ T _A ≤ +125°C		1	10	ppm/V
LOAD REGULATION	$\Delta V_{OUT}/\Delta I_L$					
A, B, C Grade		I _L = 0 mA to +10 mA source, -40°C ≤ T _A ≤ +125°C		25	80	ppm/mA
D Grade		I _L = 0 mA to -10 mA sink, -40°C ≤ T _A ≤ +125°C		50	120	ppm/mA
		I _L = 0 mA to +10 mA source, 0°C ≤ T _A ≤ +70°C		15	25	ppm/mA
		I _L = 0 mA to -10 mA sink, 0°C ≤ T _A ≤ +70°C		5	9	ppm/mA
QUIESCENT CURRENT	I _Q	-40°C ≤ T _A ≤ +125°C, no load		700	950	μA
DROPOUT VOLTAGE	V _{DO}	-40°C ≤ T _A ≤ +125°C, no load			100	mV
		-40°C ≤ T _A ≤ +125°C, I _L = 2 mA			300	mV
RIPPLE REJECTION RATIO	RRR	f _{IN} = 1 kHz		90		dB
OUTPUT CURRENT CAPACITY	I _L					
Sinking					-10	mA
Sourcing					10	mA
OUTPUT VOLTAGE NOISE	e _{Np-p}	0.1 Hz to 10.0 Hz		2.7		μV p-p
OUTPUT VOLTAGE NOISE DENSITY	e _N	1 kHz		83.5		nV/√Hz
OUTPUT VOLTAGE HYSTERESIS	ΔV_{OUT_HYS}	T _A = temperature cycled from				
A, B, C Grade		+25°C to +125°C to -40°C to +25°C (full cycle)		-13		ppm
		25°C to 125°C to 25°C (half cycle)		-97		ppm
		25°C to 70°C to 0°C to 25°C (full cycle)		-8		ppm
		25°C to 70°C to 25°C (half cycle)		-17		ppm
D Grade		25°C to 70°C to 0°C to 25°C (full cycle)		1		ppm
		25°C to 70°C to 25°C (half cycle)		5		ppm
LONG-TERM DRIFT	ΔV_{OUT_LTD}	T _A = 25°C				
A, B, C Grade		250 hours (early life drift)		19		ppm
		1000 hours		25		ppm
		4500 hours		51		ppm
D Grade		250 hours (early life drift)		3		ppm
		1000 hours		5		ppm
		4500 hours		8		ppm
TURN-ON SETTLING TIME	t _R	C _{OUT} = 0.1 μF, C _{IN} = 0.1 μF, R _{LOAD} = 1 kΩ		155		μs

SPECIFICATIONS

Table 5. (Continued)

Parameter	Symbol	Test Conditions/Comments	Min	Typ	Max	Unit
LOAD CAPACITANCE			0.1		100	μF

ADR4550 ELECTRICAL CHARACTERISTICS

Unless otherwise noted, $V_{\text{IN}} = 5.1 \text{ V to } 15 \text{ V}$, $I_{\text{L}} = 0 \text{ mA}$, $T_{\text{A}} = 25^{\circ}\text{C}$.

Table 6.

Parameter	Symbol	Test Conditions/Comments	Min	Typ	Max	Unit
OUTPUT VOLTAGE	V_{OUT}			5.000		V
INITIAL OUTPUT VOLTAGE ERROR B, C, D Grade	$V_{\text{OUT_ERR}}$				± 0.02	%
A Grade					1	mV
					± 0.04	%
					2	mV
SOLDER HEAT RESISTANCE SHIFT A, B, C, D Grade				± 0.02		%
TEMPERATURE COEFFICIENT D Grade	TCV_{OUT}	See Terminology section $0^{\circ}\text{C} \leq T_{\text{A}} \leq +70^{\circ}\text{C}$ (box method)			0.8	ppm/ $^{\circ}\text{C}$
C Grade		$0^{\circ}\text{C} \leq T_{\text{A}} \leq +70^{\circ}\text{C}$ (bowtie method)			1.6	ppm/ $^{\circ}\text{C}$
B Grade		$0^{\circ}\text{C} \leq T_{\text{A}} \leq +70^{\circ}\text{C}$ (box method)			1	ppm/ $^{\circ}\text{C}$
		$0^{\circ}\text{C} \leq T_{\text{A}} \leq +70^{\circ}\text{C}$ (bowtie method)			2	ppm/ $^{\circ}\text{C}$
		$-40^{\circ}\text{C} \leq T_{\text{A}} \leq +125^{\circ}\text{C}$ (box method)			2	ppm/ $^{\circ}\text{C}$
		$-40^{\circ}\text{C} \leq T_{\text{A}} \leq +125^{\circ}\text{C}$ (bowtie method)			4	ppm/ $^{\circ}\text{C}$
A Grade		$-40^{\circ}\text{C} \leq T_{\text{A}} \leq +125^{\circ}\text{C}$ (box method)			4	ppm/ $^{\circ}\text{C}$
		$-40^{\circ}\text{C} \leq T_{\text{A}} \leq +125^{\circ}\text{C}$ (bowtie method)			8	ppm/ $^{\circ}\text{C}$
LINE REGULATION	$\Delta V_{\text{OUT}}/\Delta V_{\text{IN}}$	$-40^{\circ}\text{C} \leq T_{\text{A}} \leq +125^{\circ}\text{C}$		1	10	ppm/V
LOAD REGULATION A, B, C Grade	$\Delta V_{\text{OUT}}/\Delta I_{\text{L}}$	$I_{\text{L}} = 0 \text{ mA to } +10 \text{ mA source}$, $-40^{\circ}\text{C} \leq T_{\text{A}} \leq +125^{\circ}\text{C}$		25	80	ppm/mA
		$I_{\text{L}} = 0 \text{ mA to } -10 \text{ mA sink}$, $-40^{\circ}\text{C} \leq T_{\text{A}} \leq +125^{\circ}\text{C}$		35	120	ppm/mA
D Grade		$I_{\text{L}} = 0 \text{ mA to } +10 \text{ mA source}$, $0^{\circ}\text{C} \leq T_{\text{A}} \leq +70^{\circ}\text{C}$		6	12	ppm/mA
		$I_{\text{L}} = 0 \text{ mA to } -10 \text{ mA sink}$, $0^{\circ}\text{C} \leq T_{\text{A}} \leq +70^{\circ}\text{C}$		4	9	ppm/mA
QUIESCENT CURRENT	I_{Q}	$-40^{\circ}\text{C} \leq T_{\text{A}} \leq +125^{\circ}\text{C}$, no load		700	950	μA
DROPOUT VOLTAGE	V_{DO}	$-40^{\circ}\text{C} \leq T_{\text{A}} \leq +125^{\circ}\text{C}$, no load			100	mV
		$-40^{\circ}\text{C} \leq T_{\text{A}} \leq +125^{\circ}\text{C}$, $I_{\text{L}} = 2 \text{ mA}$			300	mV
RIPPLE REJECTION RATIO	RRR	$f_{\text{IN}} = 1 \text{ kHz}$		90		dB
OUTPUT CURRENT CAPACITY Sinking	I_{L}				-10	mA
Sourcing					10	mA
OUTPUT VOLTAGE NOISE	$e_{\text{Np-p}}$	0.1 Hz to 10.0 Hz		2.8		$\mu\text{V p-p}$
OUTPUT VOLTAGE NOISE DENSITY	e_{N}	1 kHz		95.3		nV/ $\sqrt{\text{Hz}}$
OUTPUT VOLTAGE HYSTERESIS A, B, C Grade	$\Delta V_{\text{OUT_HYS}}$	$T_{\text{A}} = \text{temperature cycled from}$ $+25^{\circ}\text{C to } +125^{\circ}\text{C to } -40^{\circ}\text{C to } +25^{\circ}\text{C}$ (full cycle)		-13		ppm
		$25^{\circ}\text{C to } 125^{\circ}\text{C to } 25^{\circ}\text{C}$ (half cycle)		-97		ppm
		$25^{\circ}\text{C to } 70^{\circ}\text{C to } 0^{\circ}\text{C to } 25^{\circ}\text{C}$ (full cycle)		-8		ppm
		$25^{\circ}\text{C to } 70^{\circ}\text{C to } 25^{\circ}\text{C}$ (half cycle)		-17		ppm
D Grade		$25^{\circ}\text{C to } 70^{\circ}\text{C to } 0^{\circ}\text{C to } 25^{\circ}\text{C}$ (full cycle)		1		ppm
		$25^{\circ}\text{C to } 70^{\circ}\text{C to } 25^{\circ}\text{C}$ (half cycle)		5		ppm

SPECIFICATIONS

Table 6. (Continued)

Parameter	Symbol	Test Conditions/Comments	Min	Typ	Max	Unit
LONG-TERM DRIFT	$\Delta V_{\text{OUT_LTD}}$	$T_A = 25^\circ\text{C}$				
A, B, C Grade		250 hours (early life drift)		19		ppm
		1000 hours		25		ppm
		4500 hours		51		ppm
D Grade		250 hours (early life drift)		3		ppm
		1000 hours		5		ppm
		4500 hours		8		ppm
TURN-ON SETTLING TIME	t_R	$C_{\text{OUT}} = 0.1 \mu\text{F}$, $C_{\text{IN}} = 0.1 \mu\text{F}$, $R_{\text{LOAD}} = 1 \text{ k}\Omega$		160		μs
LOAD CAPACITANCE			0.1		100	μF

ABSOLUTE MAXIMUM RATINGS

$T_A = 25^\circ\text{C}$, unless otherwise noted.

Table 7.

Parameter	Rating
Supply Voltage	16 V
Operating Temperature Range	-40°C to +125°C
ADR4525, ADR4540, ADR4550 C and D Grade Only	0°C to 70°C
Storage Temperature Range	-65°C to +150°C
Junction Temperature Range	-65°C to +150°C
Electrostatic Discharge (ESD) Human Body Model (HBM)	6 kV
Moisture Sensitivity Level Rating	MSL-1

Stresses at or above those listed under Absolute Maximum Ratings may cause permanent damage to the product. This is a stress rating only; functional operation of the product at these or any other conditions above those indicated in the operational section of this specification is not implied. Operation beyond the maximum operating conditions for extended periods may affect product reliability.

THERMAL RESISTANCE

Thermal performance is directly linked to printed circuit board (PCB) design and operating environment. Close attention to PCB thermal design is required.

Table 8. Thermal Resistance

Package Type	θ_{JA}	θ_{JC}^1	Unit
8-Lead SOIC ²			
1-Layer JEDEC Board	N/A ³	63	°C/W
2-Layer JEDEC Board	120	N/A ³	°C/W
8-Lead LCC	120	N/A ³	°C/W

¹ For the θ_{JC} test, 100 μm thermal interface material (TIM) is used. TIM is assumed to have 3.6 W/mK.

² Thermal impedance simulated values are based on a JEDEC thermal test board. See JEDEC JESD51.

³ N/A means not applicable.

ESD CAUTION

ESD (electrostatic discharge) sensitive device. Charged devices and circuit boards can discharge without detection. Although this product features patented or proprietary protection circuitry, damage may occur on devices subjected to high energy ESD. Therefore, proper ESD precautions should be taken to avoid performance degradation or loss of functionality.

PIN CONFIGURATIONS AND FUNCTION DESCRIPTIONS

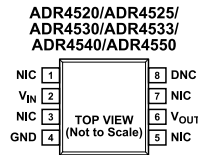

NOTES
 1. NC = NO CONNECT.
 THIS PIN IS NOT CONNECTED INTERNALLY.
 2. DNC = DO NOT CONNECT. DO NOT CONNECT TO THIS PIN.

Figure 3. 8-Lead SOIC Pin Configuration

Table 9. 8-Lead SOIC Pin Function Descriptions

Pin No.	Mnemonic	Description
1	NIC	Not Internally Connected. This pin is not connected internally.
2	V _{IN}	Input Voltage Connection.
3	NIC	Not Internally Connected. This pin is not connected internally.
4	GND	Ground.
5	NIC	Not Internally Connected. This pin is not connected internally.
6	V _{OUT}	Output Voltage.
7	NIC	Not Internally Connected. This pin is not connected internally.
8	DNC	Do Not Connect. Do not connect to this pin.

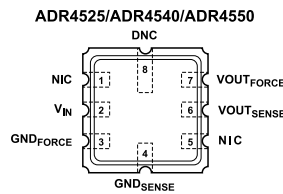

NOTES
 1. NIC = NO INTERNAL CONNECTION.
 THIS PIN IS NOT CONNECTED INTERNALLY.
 2. DNC = DO NOT CONNECT. DO NOT CONNECT TO THIS PIN.

Figure 4. 8-Lead LCC Pin Configuration

Table 10. 8-Lead LCC Pin Function Descriptions

Pin No.	Mnemonic	Description
1	NIC	Not Internally Connected. This pin is not connected internally.
2	V _{IN}	Input Voltage Connection.
3	GND _{FORCE}	Ground connection.
4	GND _{SENSE}	Ground sensing connection. Connect directly to the ground connection of the load device.
5	NIC	Not Internally Connected. This pin is not connected internally.
6	VOUT _{SENSE}	Reference Voltage Output sensing connection. Connect directly to the voltage input of the load device.
7	VOUT _{FORCE}	Reference Voltage Output.
8	DNC	Do Not Connect. Do not connect to this pin.

TYPICAL PERFORMANCE CHARACTERISTICS

T_A = 25°C, unless otherwise noted.

ADR4520

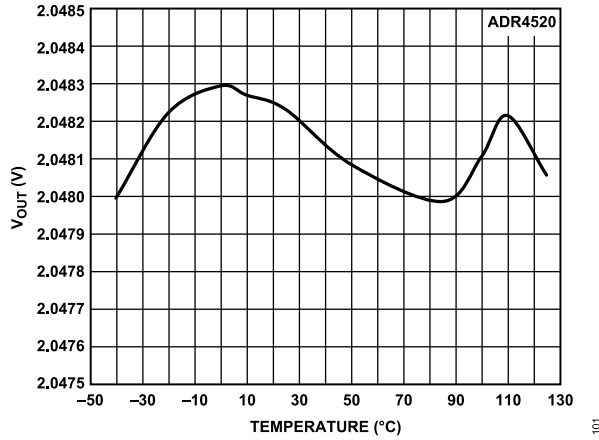

Figure 5. ADR4520 B Grade Output Voltage vs. Temperature

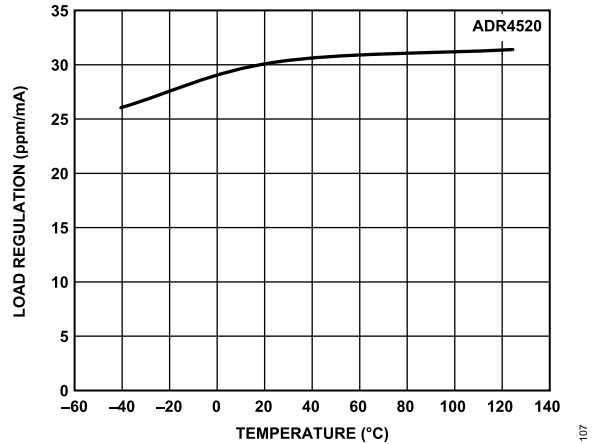

Figure 8. ADR4520 Load Regulation vs. Temperature (Sourcing)

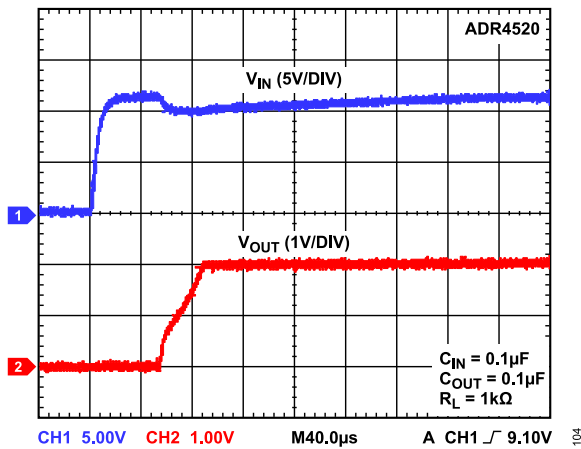

Figure 6. ADR4520 Output Voltage Start-Up Response

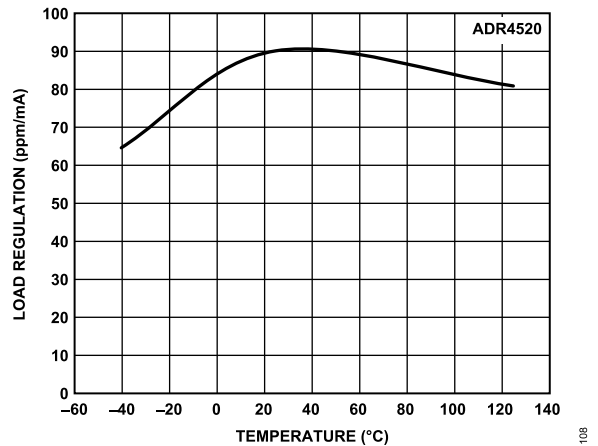

Figure 9. ADR4520 Load Regulation vs. Temperature (Sinking)

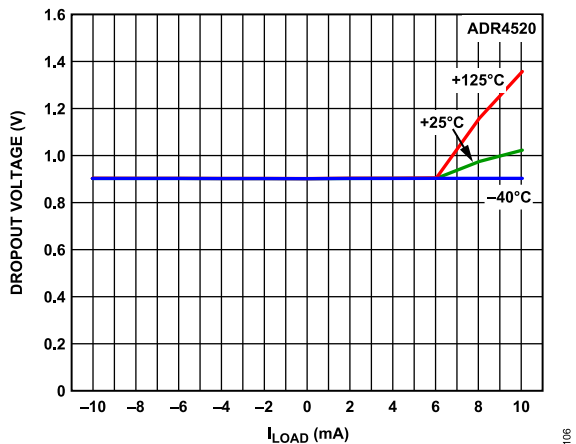

Figure 7. ADR4520 Dropout Voltage vs. Load Current

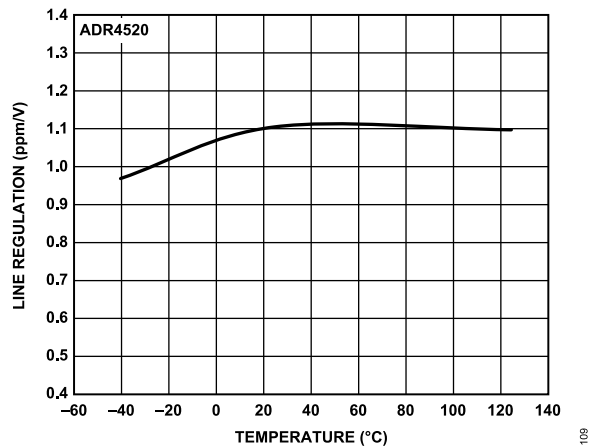

Figure 10. ADR4520 Line Regulation vs. Temperature

TYPICAL PERFORMANCE CHARACTERISTICS

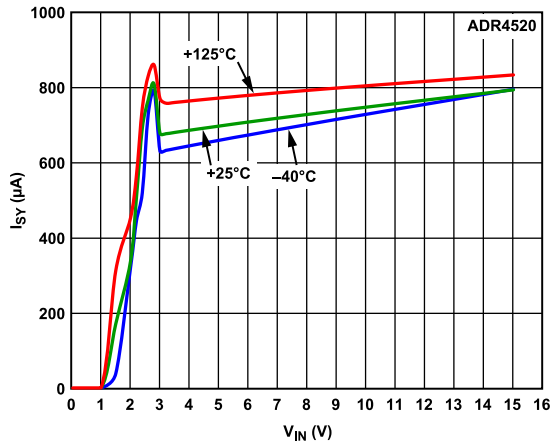

Figure 11. ADR4520 Supply Current (I_S) vs. Supply Voltage

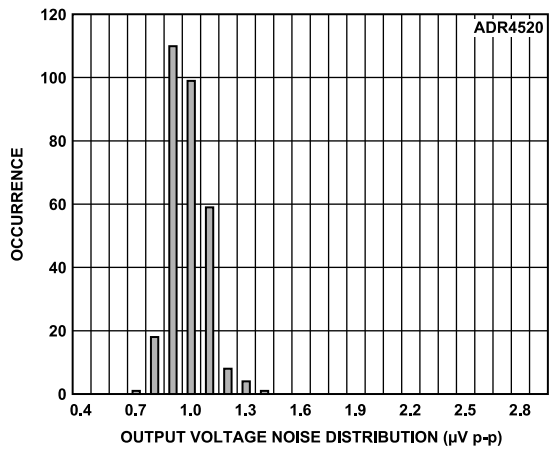

Figure 12. ADR4520 Output Voltage Noise (Maximum Amplitude from 0.1 Hz to 10 Hz)

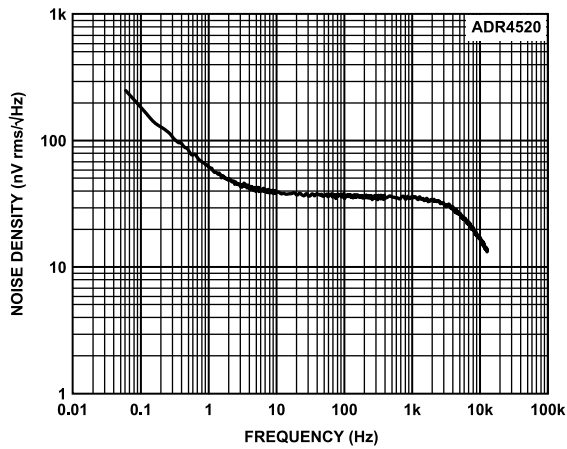

Figure 13. ADR4520 Output Noise Spectral Density

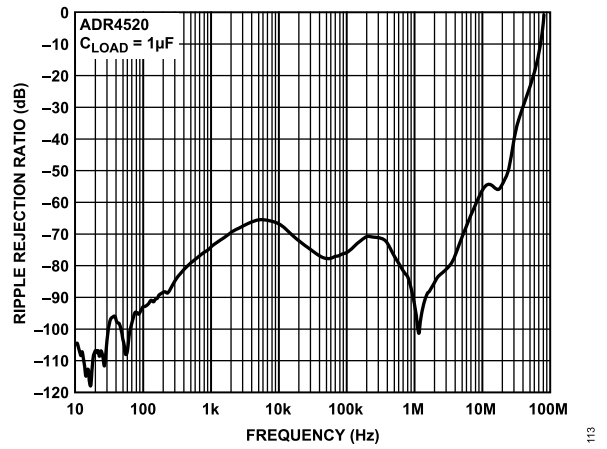

Figure 14. ADR4520 Ripple Rejection Ratio vs. Frequency

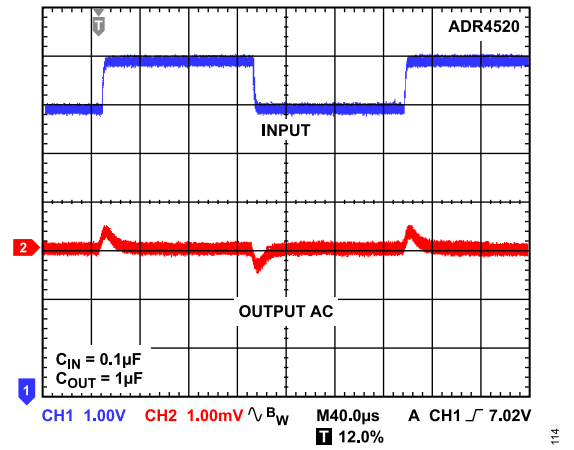

Figure 15. ADR4520 Line Transient Response

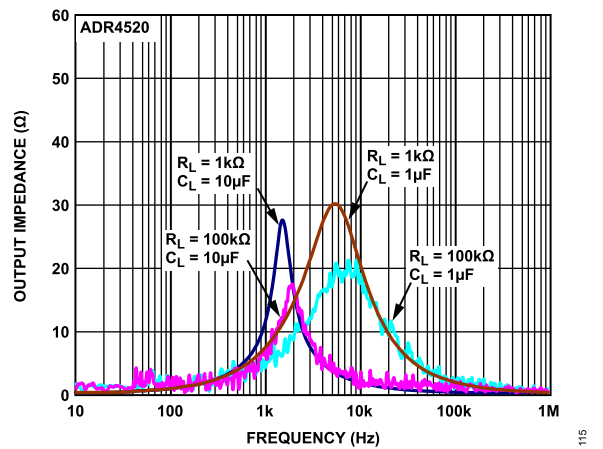

Figure 16. ADR4520 Output Impedance vs. Frequency

TYPICAL PERFORMANCE CHARACTERISTICS

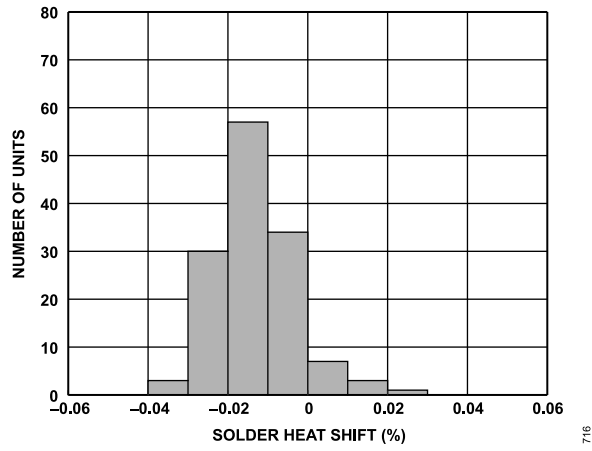

Figure 17. ADR4520 Solder Heat Resistance Shift (3 × Reflow)

TYPICAL PERFORMANCE CHARACTERISTICS

ADR4525

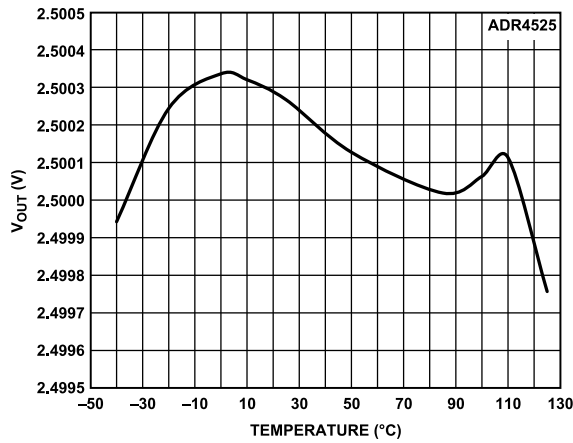

Figure 18. ADR4525 B Grade Output Voltage vs. Temperature

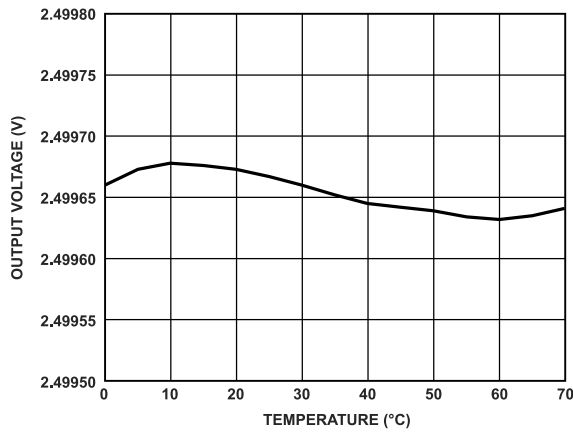

Figure 19. ADR4525 C Grade Output Voltage vs. Temperature

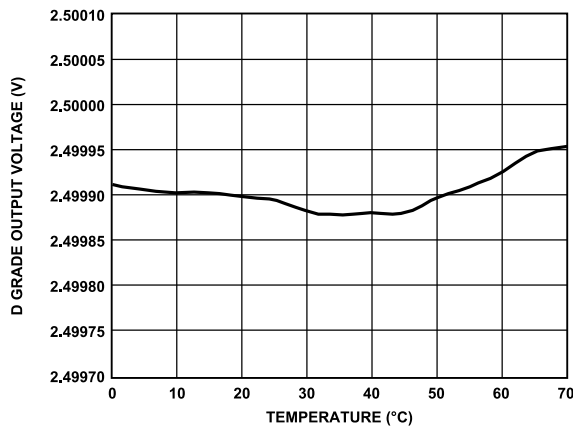

Figure 20. ADR4525 D Grade Output Voltage vs. Temperature

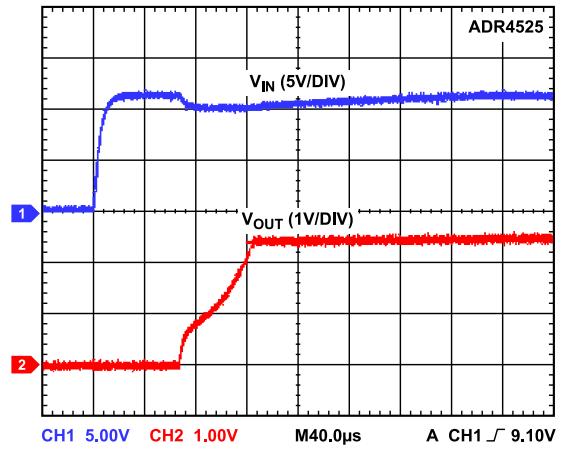

Figure 21. ADR4525 Output Voltage Start-Up Response

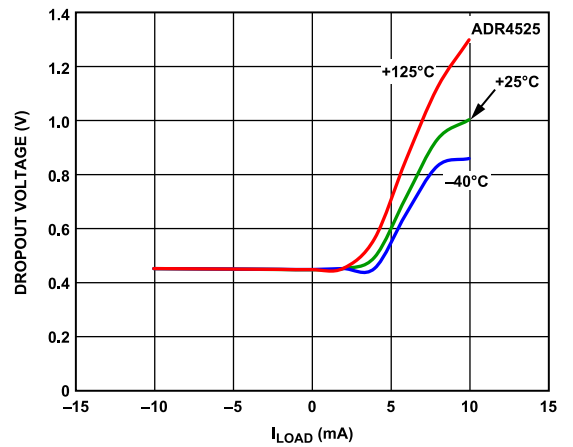

Figure 22. ADR4525 Dropout Voltage vs. Load Current

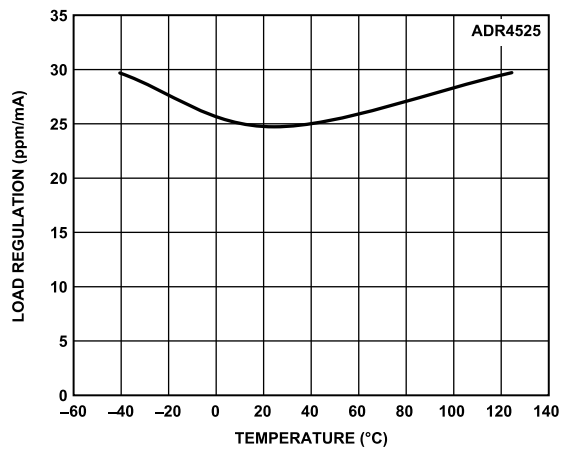

Figure 23. ADR4525 Load Regulation vs. Temperature (Sourcing)

TYPICAL PERFORMANCE CHARACTERISTICS

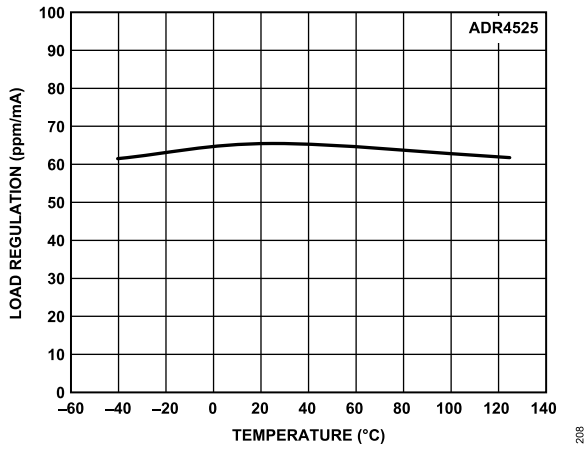

Figure 24. ADR4525 Load Regulation vs. Temperature (Sinking)

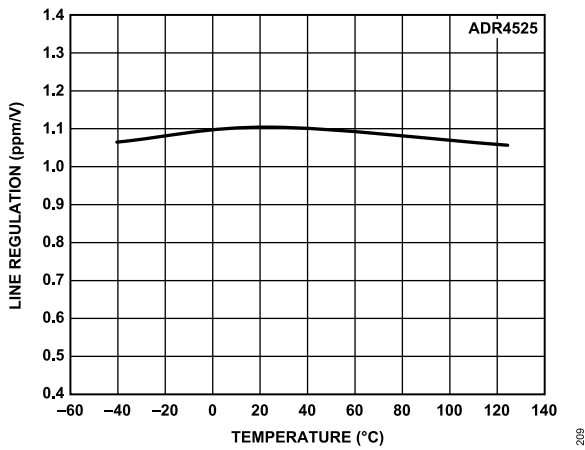

Figure 25. ADR4525 Line Regulation vs. Temperature

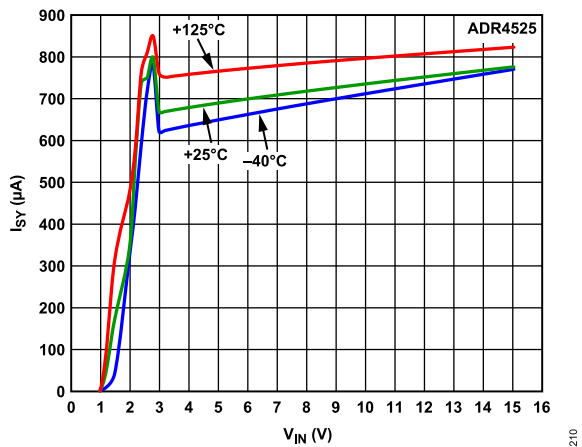

Figure 26. ADR4525 Supply Current vs. Supply Voltage

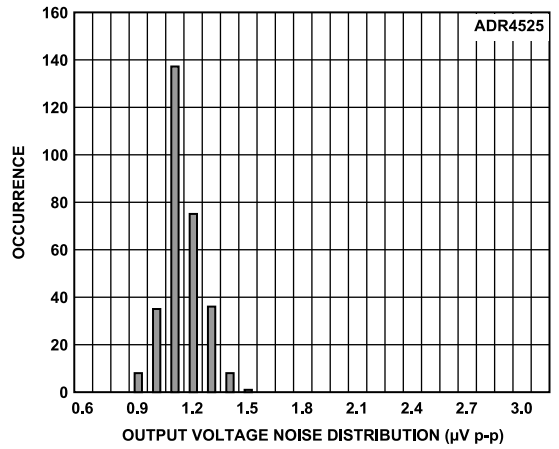

Figure 27. ADR4525 Output Voltage Noise (Maximum Amplitude from 0.1 Hz to 10 Hz)

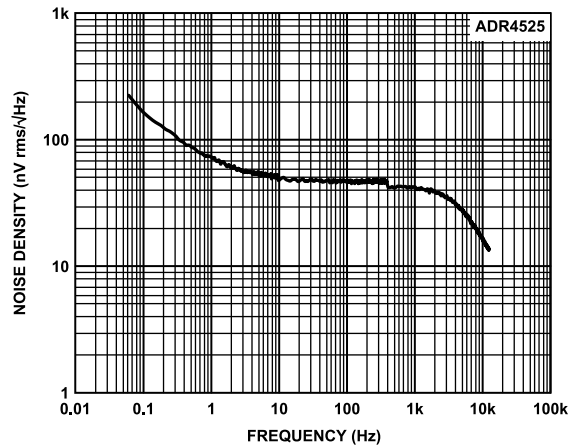

Figure 28. ADR4525 Output Noise Spectral Density

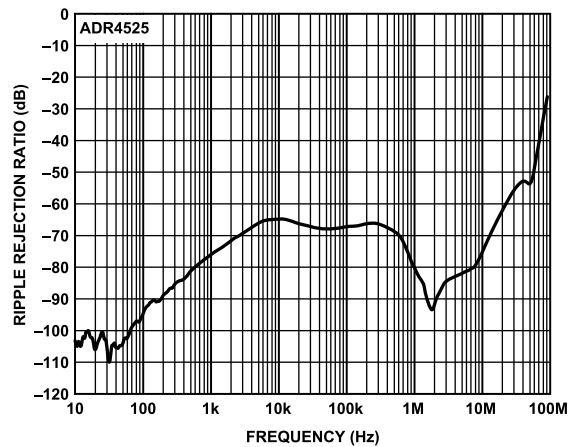

Figure 29. ADR4525 Ripple Rejection Ratio vs. Frequency

TYPICAL PERFORMANCE CHARACTERISTICS

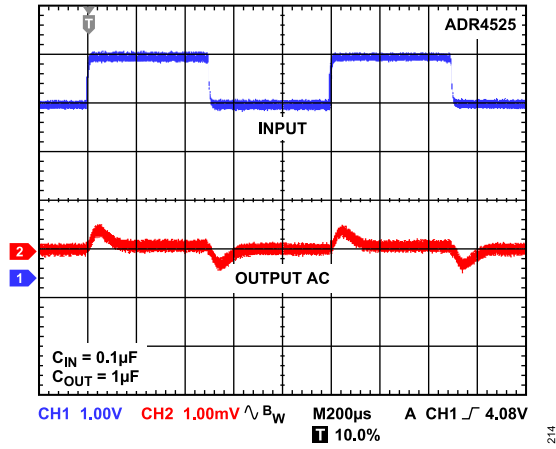

Figure 30. ADR4525 Line Transient Response

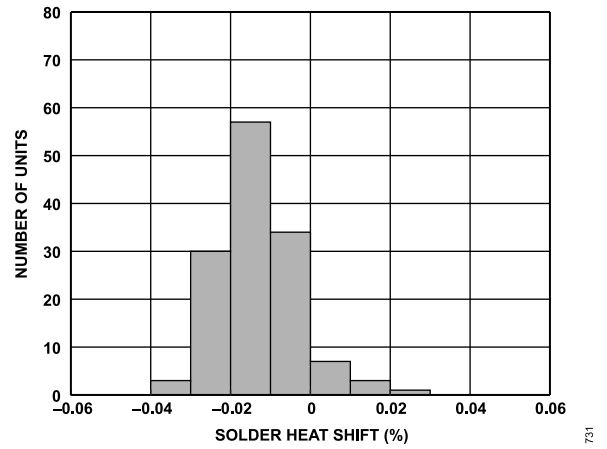

Figure 33. ADR4525 Solder Heat Resistance Shift (3 × Reflow)

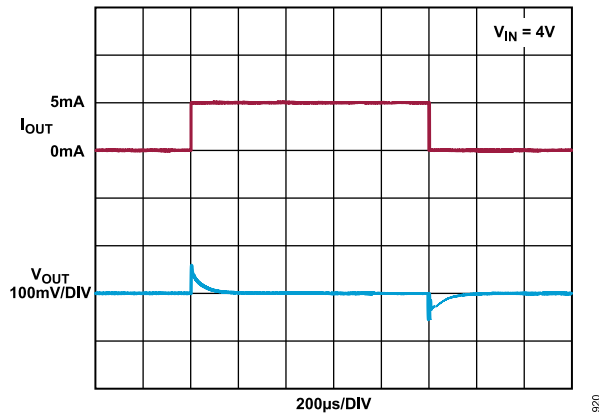

Figure 31. ADR4525 A, B, and C Grades Load Transient Response (Sinking)

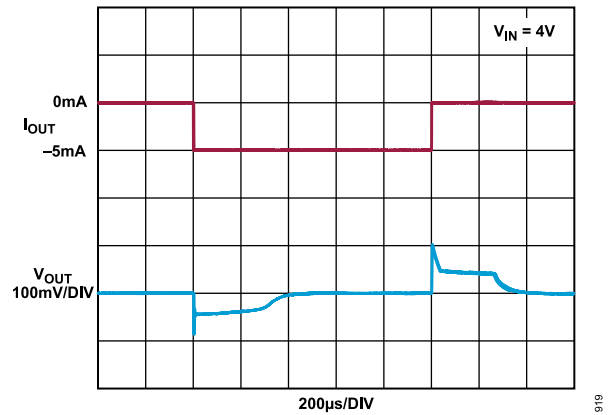

Figure 34. ADR4525 A, B, and C Grades Load Transient Response (Sourcing)

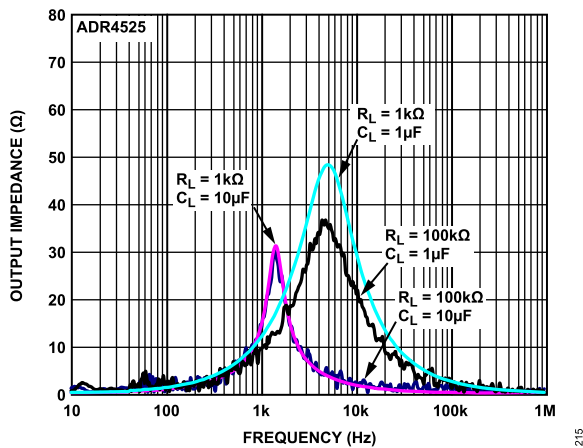

Figure 32. ADR4525 Output Impedance vs. Frequency

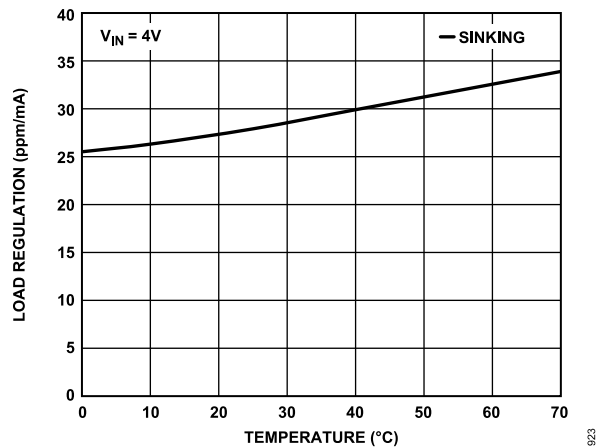

Figure 35. ADR4525 D Grade Load Regulation vs. Temperature (Sinking)

TYPICAL PERFORMANCE CHARACTERISTICS

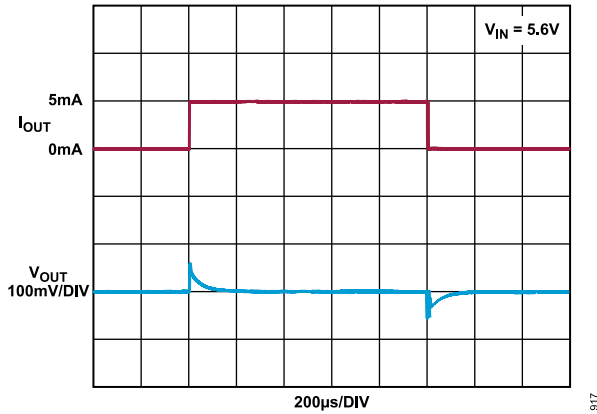

Figure 36. ADR4525 D Grade Load Transient Response (Sinking)

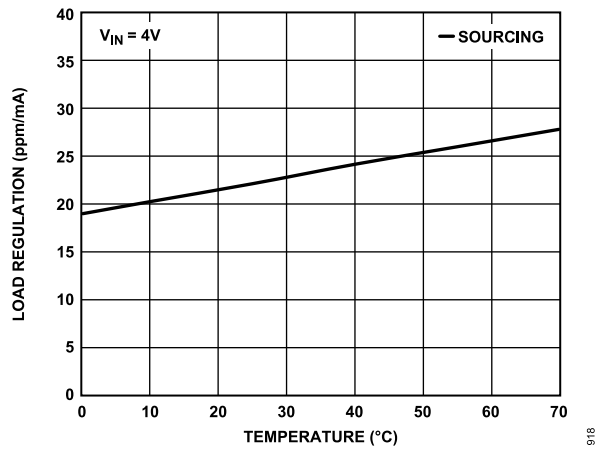

Figure 37. ADR4525 D Grade Load Regulation vs. Temperature (Sourcing)

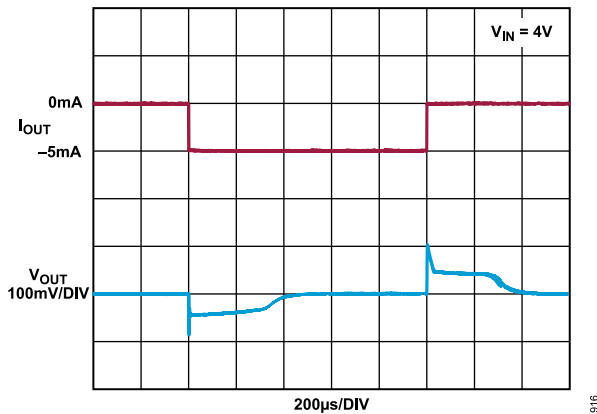

Figure 38. ADR4525 D Grade Load Transient Response (Sourcing)

TYPICAL PERFORMANCE CHARACTERISTICS

ADR4530

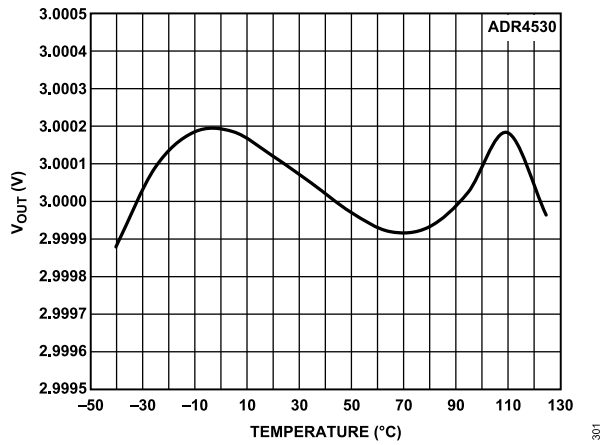

Figure 39. ADR4530 B Grade Output Voltage vs. Temperature

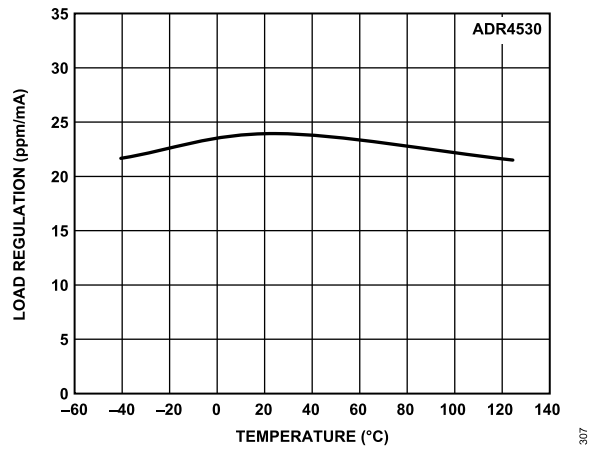

Figure 42. ADR4530 Load Regulation vs. Temperature (Sourcing)

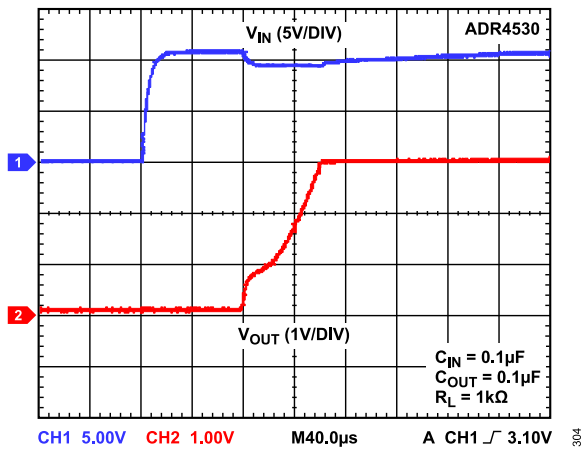

Figure 40. ADR4530 Output Voltage Start-Up Response

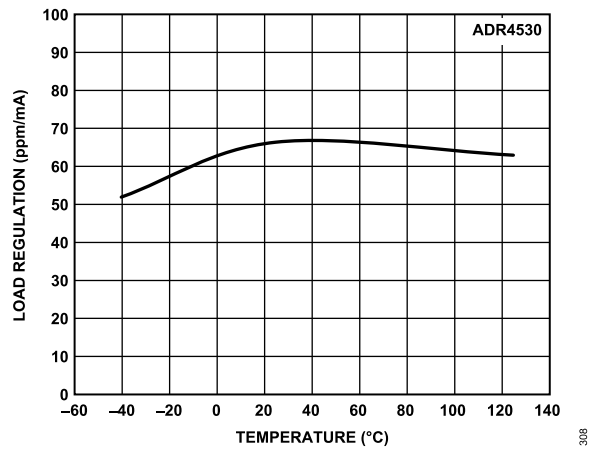

Figure 43. ADR4530 Load Regulation vs. Temperature (Sinking)

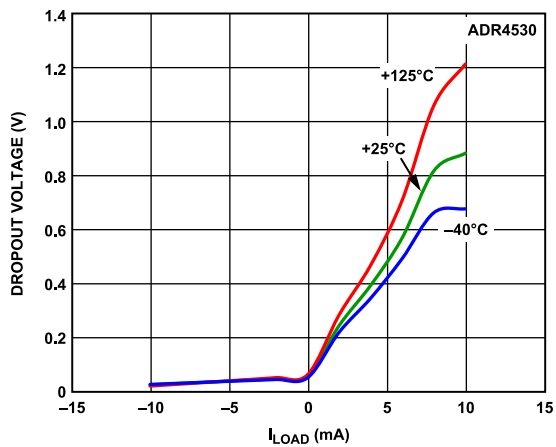

Figure 41. ADR4530 Dropout Voltage vs. Load Current

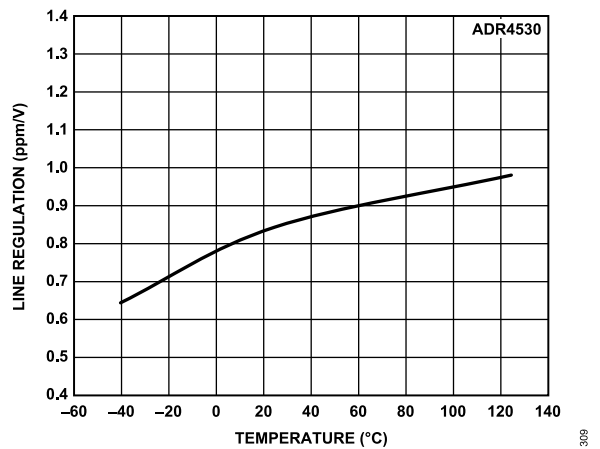

Figure 44. ADR4530 Line Regulation vs. Temperature

TYPICAL PERFORMANCE CHARACTERISTICS

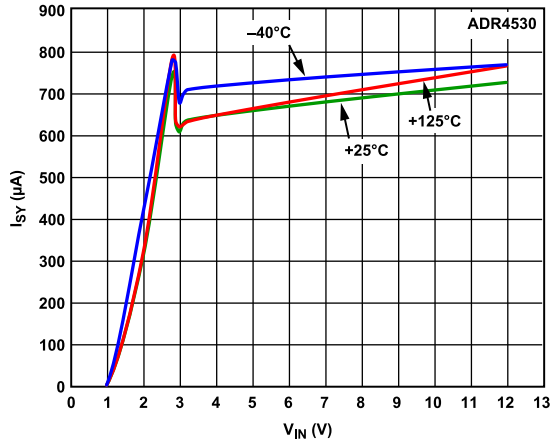

Figure 45. ADR4530 Supply Current vs. Supply Voltage

310

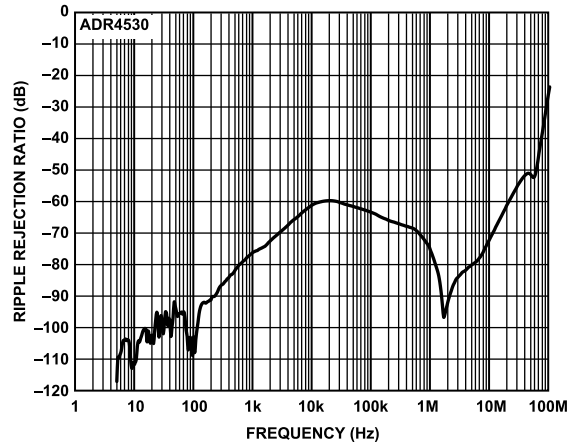

Figure 48. ADR4530 Ripple Rejection Ratio vs. Frequency

313

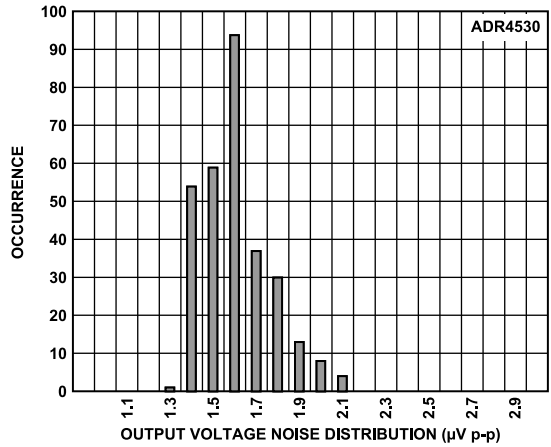

Figure 46. ADR4530 Output Voltage Noise (Maximum Amplitude from 0.1 Hz to 10 Hz)

311

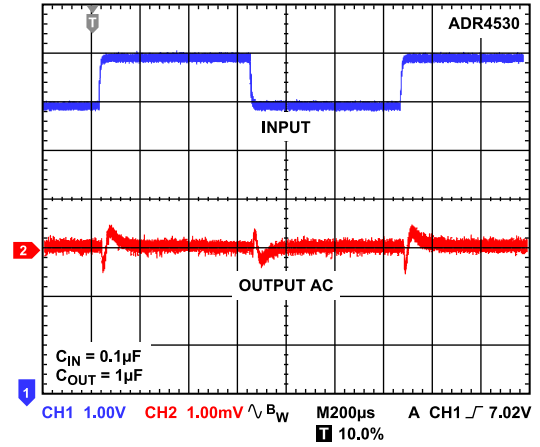

Figure 49. ADR4530 Line Transient Response

314

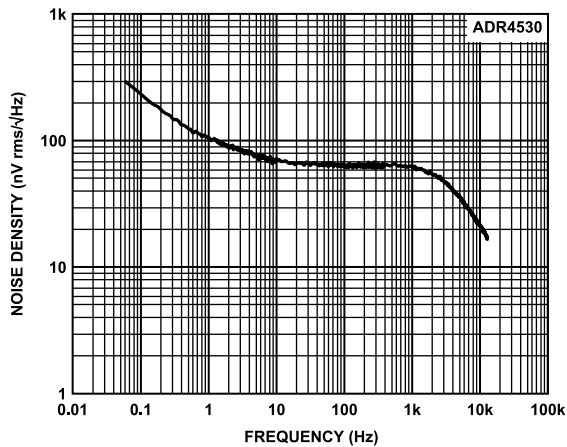

Figure 47. ADR4530 Output Noise Spectral Density

312

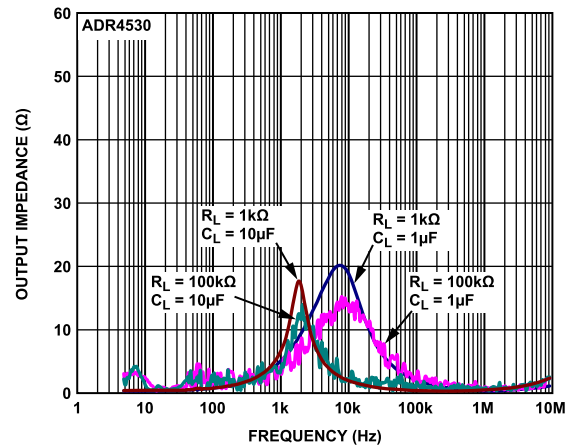

Figure 50. ADR4530 Output Impedance vs. Frequency

315

TYPICAL PERFORMANCE CHARACTERISTICS

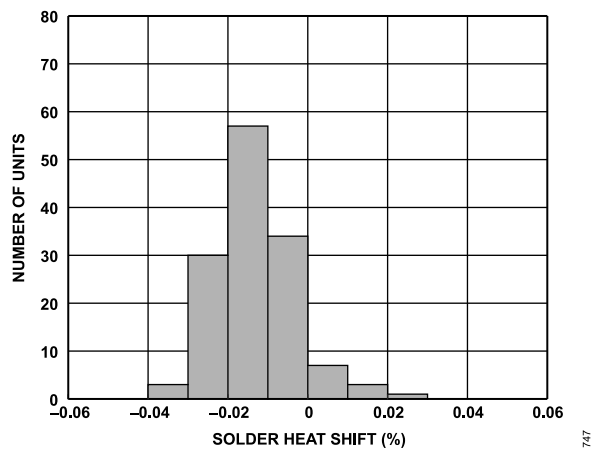

Figure 51. ADR4530 Solder Heat Resistance Shift (3 × Reflow)

TYPICAL PERFORMANCE CHARACTERISTICS

ADR4533

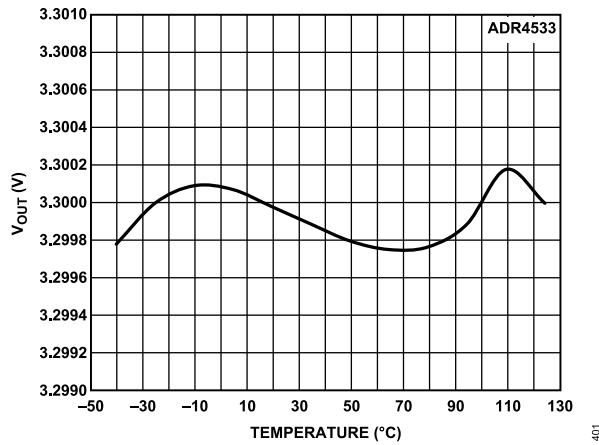

Figure 52. ADR4533 B Grade Output Voltage vs. Temperature

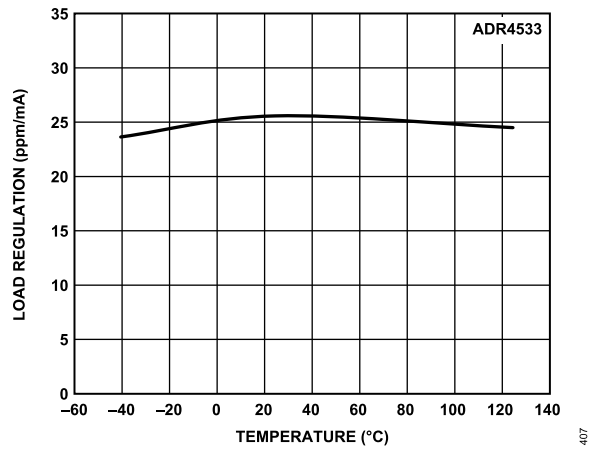

Figure 55. ADR4533 Load Regulation vs. Temperature (Sourcing)

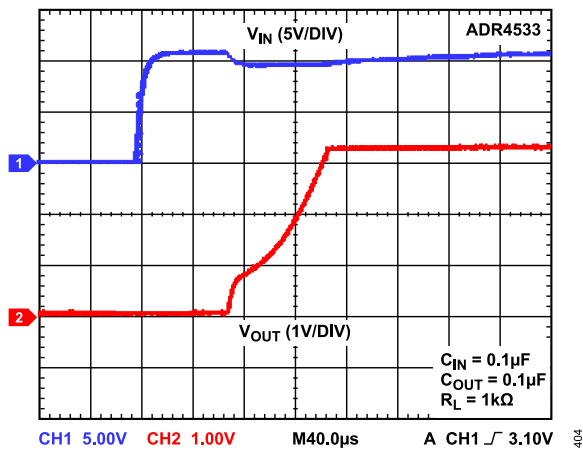

Figure 53. ADR4533 Output Voltage Start-Up Response

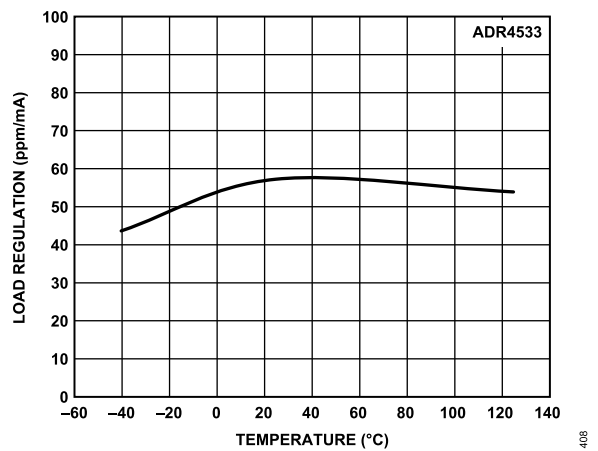

Figure 56. ADR4533 Load Regulation vs. Temperature (Sinking)

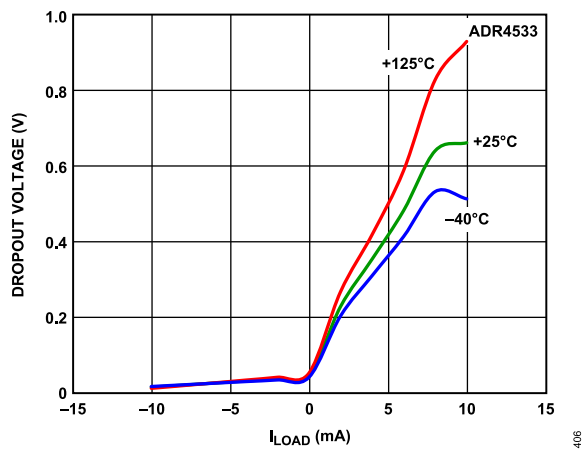

Figure 54. ADR4533 Dropout Voltage vs. Load Current

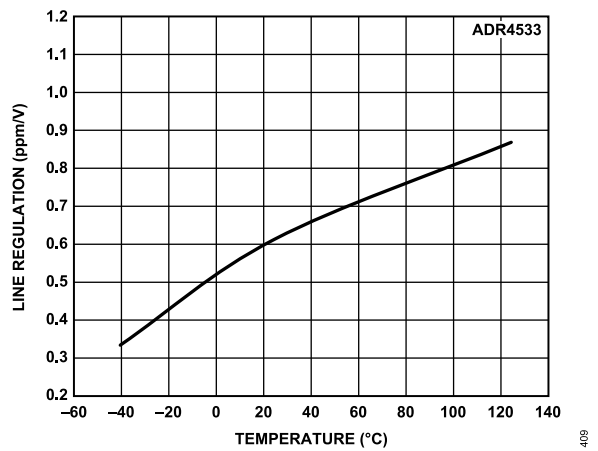

Figure 57. ADR4533 Line Regulation vs. Temperature

TYPICAL PERFORMANCE CHARACTERISTICS

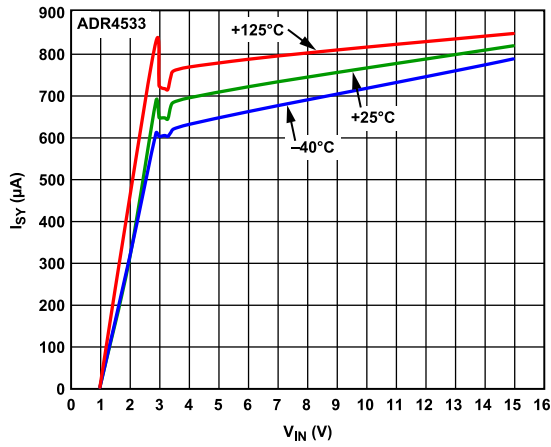

Figure 58. ADR4533 Supply Current vs. Supply Voltage

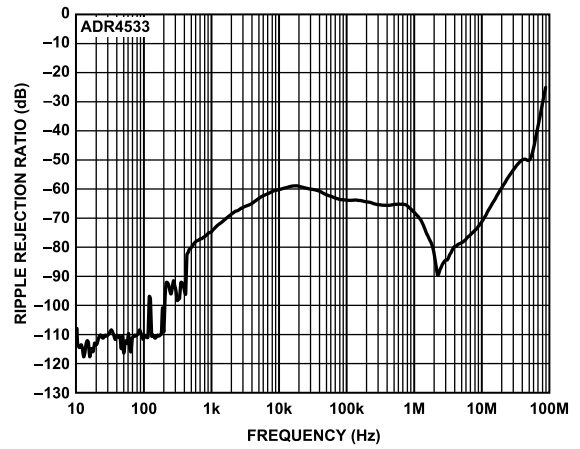

Figure 61. ADR4533 Ripple Rejection Ratio vs. Frequency

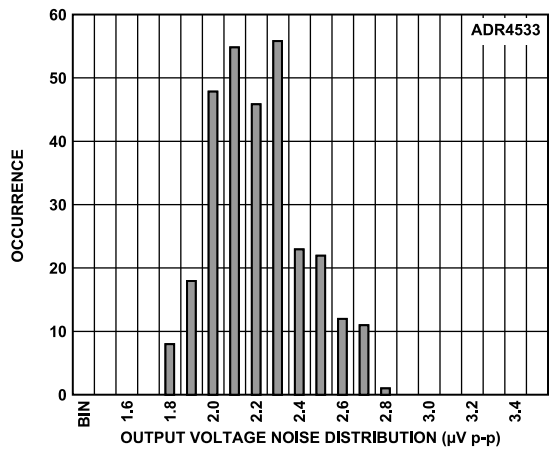

Figure 59. ADR4533 Output Voltage Noise (Maximum Amplitude from 0.1 Hz to 10 Hz)

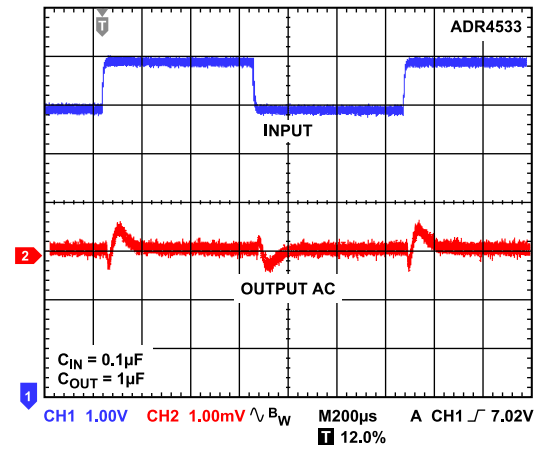

Figure 62. ADR4533 Line Transient Response

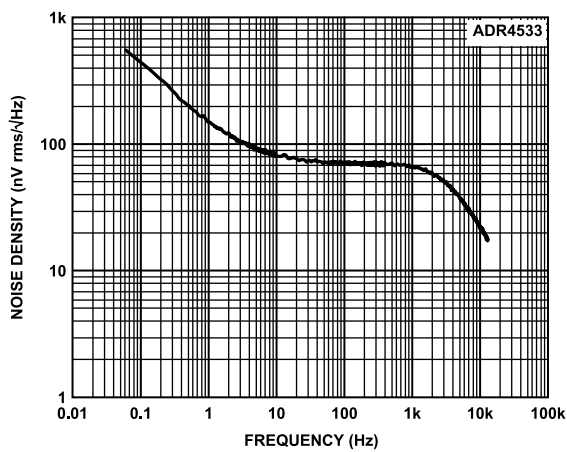

Figure 60. ADR4533 Output Noise Spectral Density

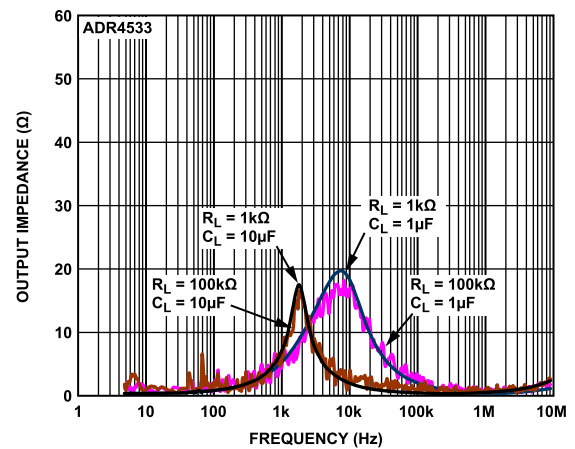

Figure 63. ADR4533 Output Impedance vs. Frequency

TYPICAL PERFORMANCE CHARACTERISTICS

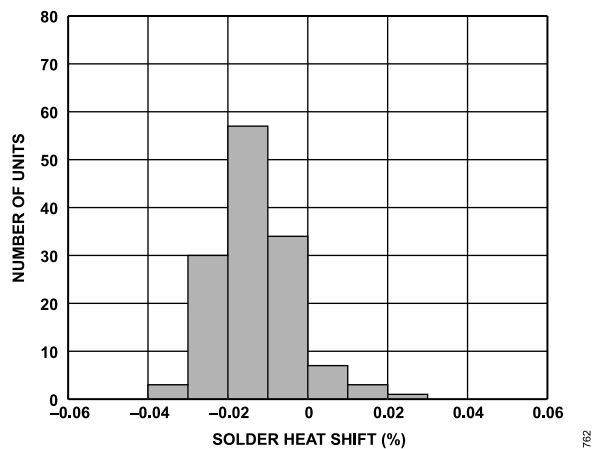

Figure 64. ADR4533 Solder Heat Resistance Shift (3 × Reflow)

TYPICAL PERFORMANCE CHARACTERISTICS

ADR4540

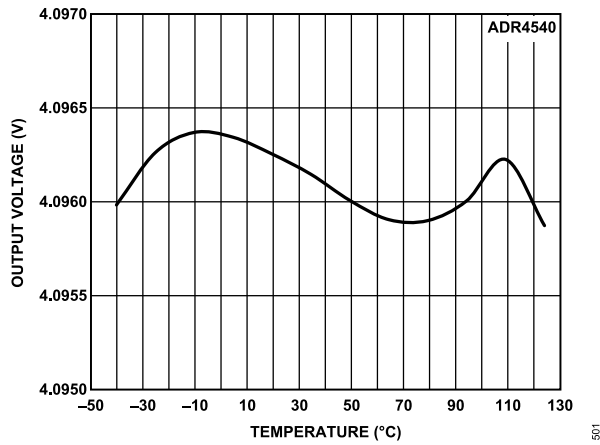

Figure 65. ADR4540 B Grade Output Voltage vs. Temperature

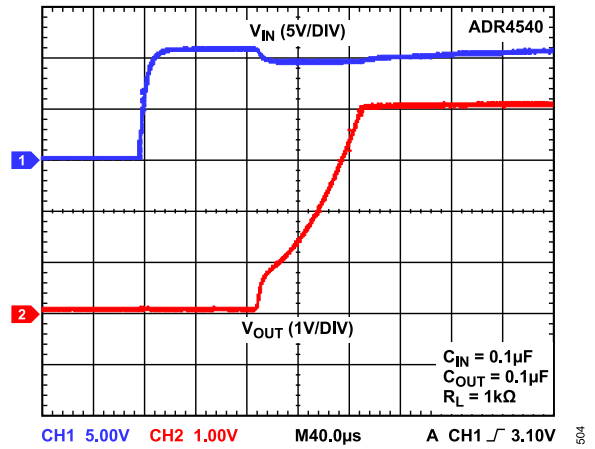

Figure 68. ADR4540 Output Voltage Start-Up Response

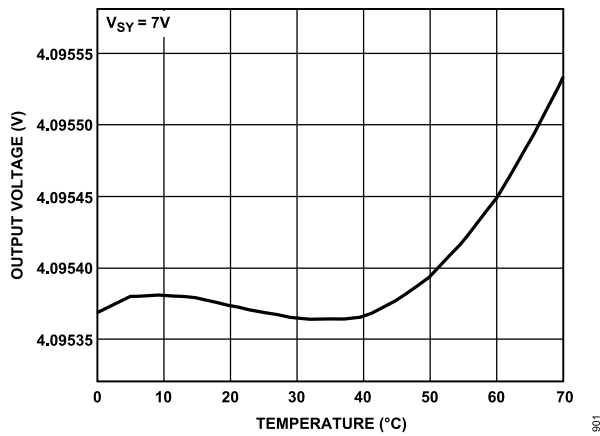

Figure 66. ADR4540 C Grade Output Voltage vs. Temperature

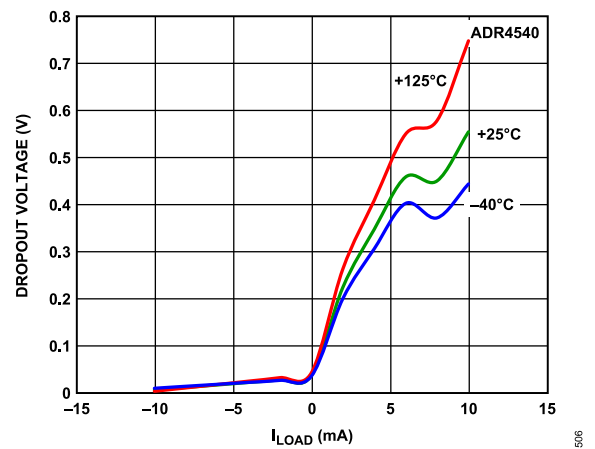

Figure 69. ADR4540 Dropout Voltage vs. Load Current

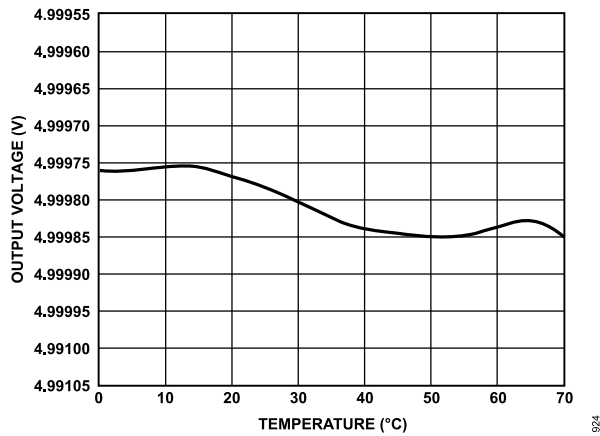

Figure 67. ADR4540 D Grade Output Voltage vs. Temperature

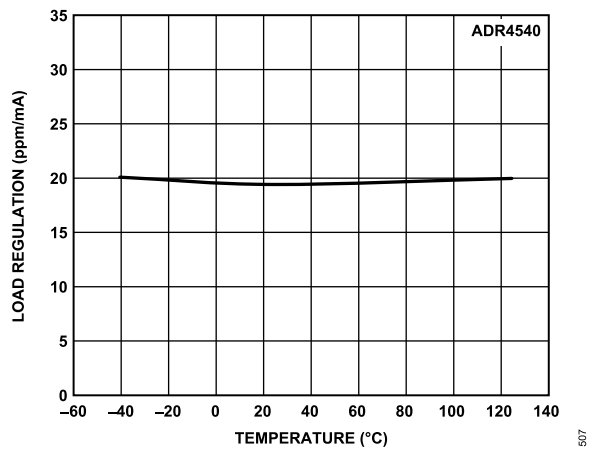

Figure 70. ADR4540 Load Regulation vs. Temperature (Sourcing)

TYPICAL PERFORMANCE CHARACTERISTICS

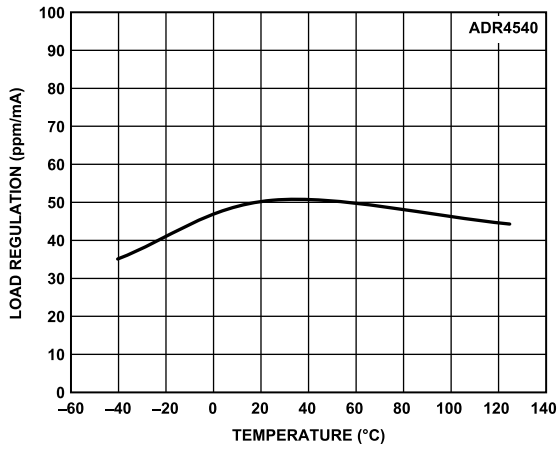

Figure 71. ADR4540 Load Regulation vs. Temperature (Sinking)

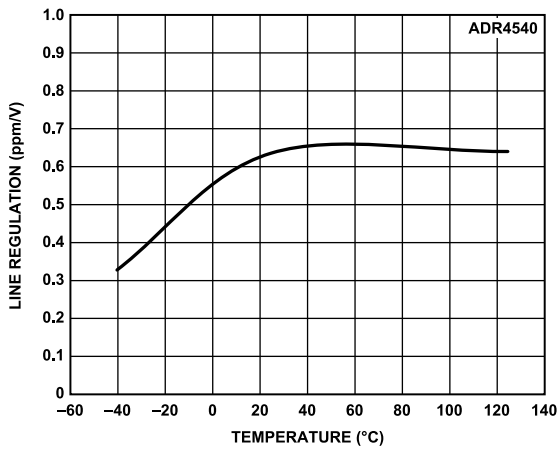

Figure 72. ADR4540 Line Regulation vs. Temperature

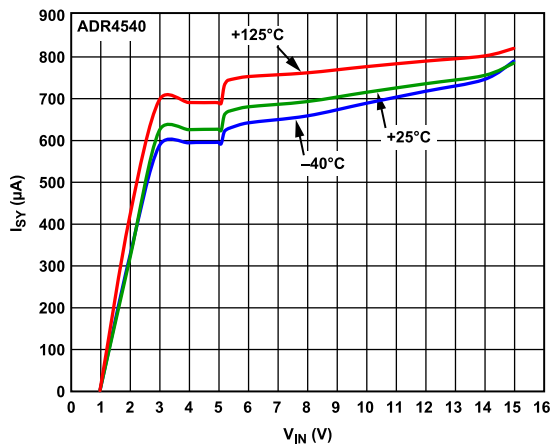

Figure 73. ADR4540 Supply Current vs. Supply Voltage

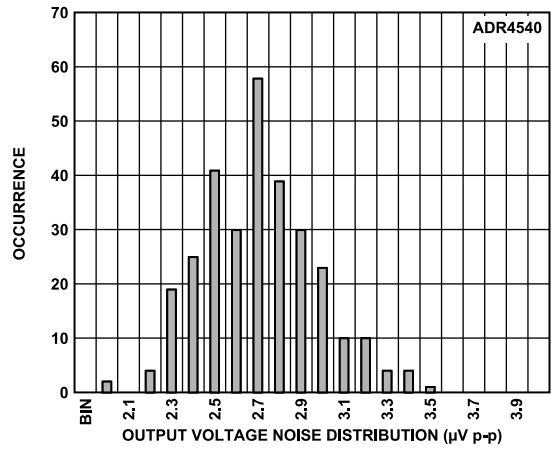

Figure 74. ADR4540 Output Voltage Noise (Maximum Amplitude from 0.1 Hz to 10 Hz)

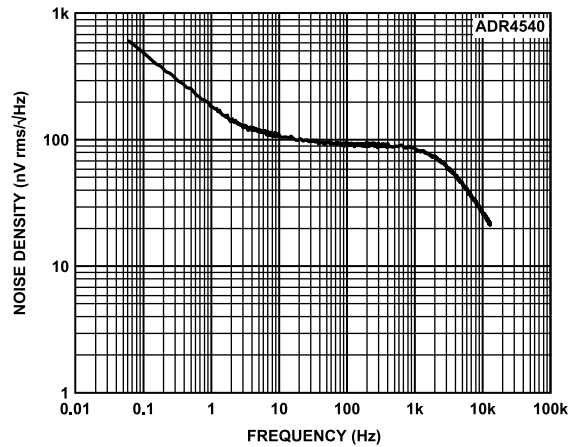

Figure 75. ADR4540 Output Noise Spectral Density

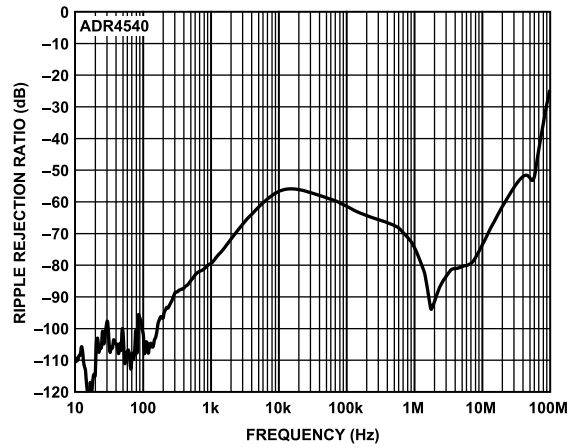

Figure 76. ADR4540 Ripple Rejection Ratio vs. Frequency

TYPICAL PERFORMANCE CHARACTERISTICS

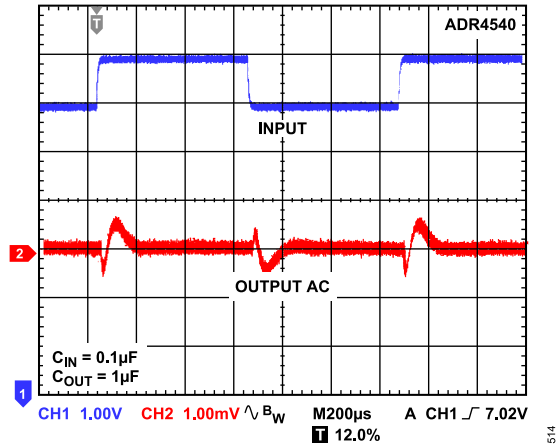

Figure 77. ADR4540 Line Transient Response

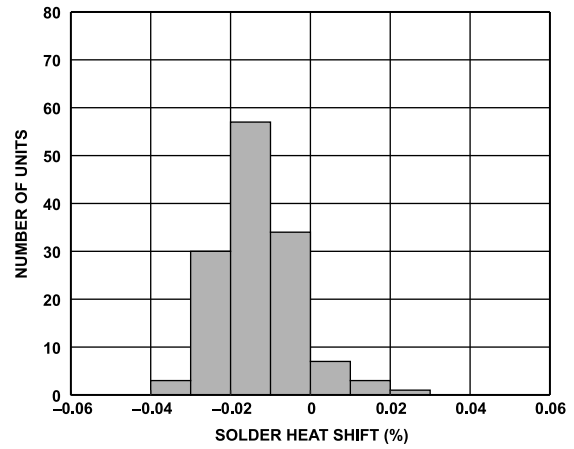

Figure 80. ADR4540 Solder Heat Resistance Shift (3 x Reflow)

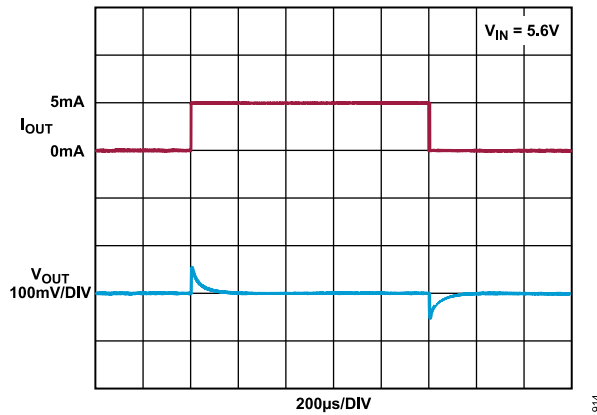

Figure 78. ADR4540 A, B, and C Grades Load Transient Response (Sinking)

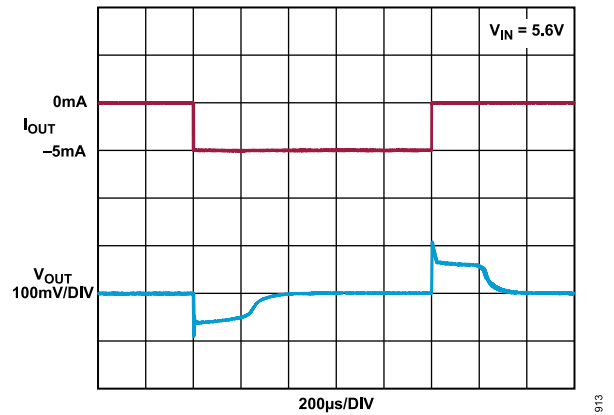

Figure 81. ADR4540 A, B, and C Grades Load Transient Response (Sourcing)

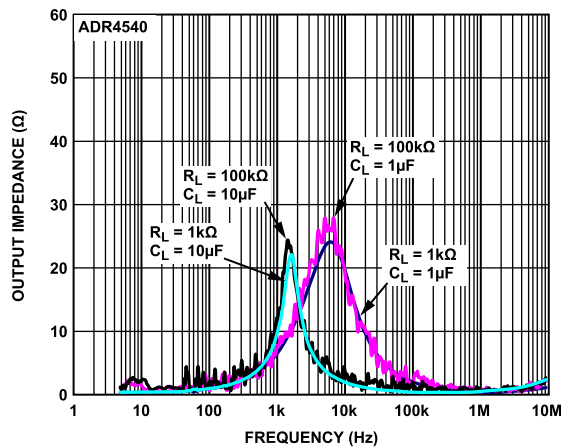

Figure 79. ADR4540 Output Impedance vs. Frequency

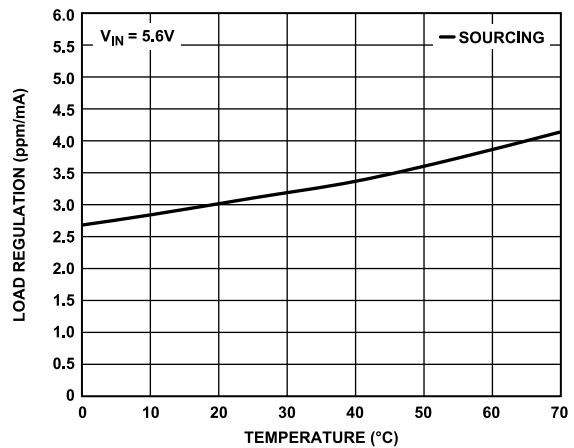

Figure 82. ADR4540 D Grade Load Regulation vs. Temperature (Sinking)

TYPICAL PERFORMANCE CHARACTERISTICS

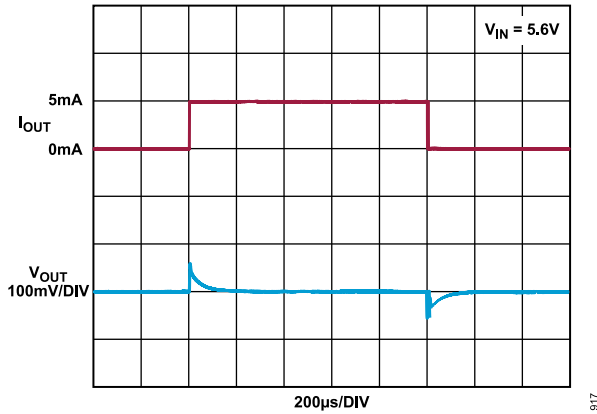

Figure 83. ADR4540 D Grade Load Transient Response (Sinking)

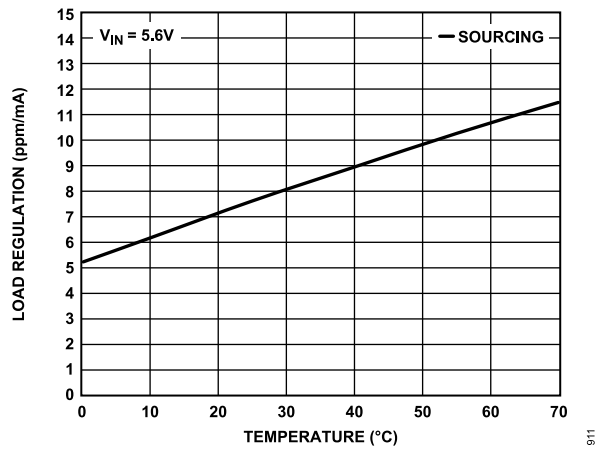

Figure 84. ADR4540 D Grade Load Regulation vs. Temperature (Sourcing)

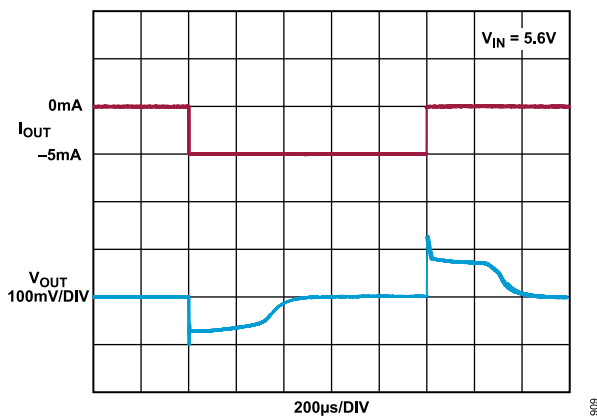

Figure 85. ADR4540 D Grade Load Transient Response (Sourcing)

TYPICAL PERFORMANCE CHARACTERISTICS

ADR4550

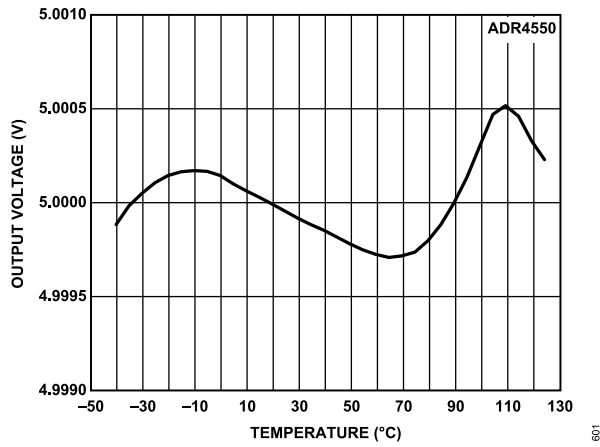

Figure 86. ADR4550 B Grade Output Voltage vs. Temperature

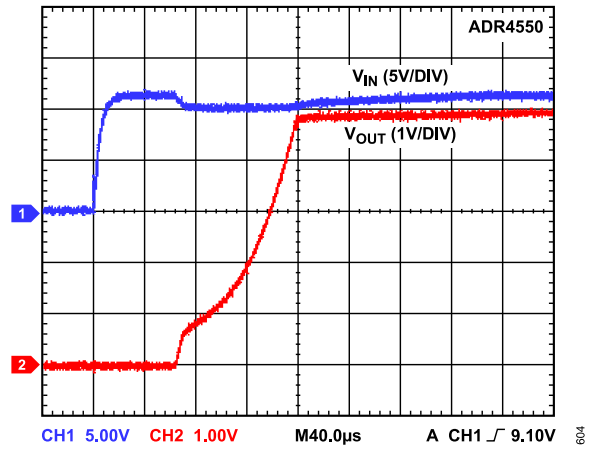

Figure 89. ADR4550 Output Voltage Start-Up Response

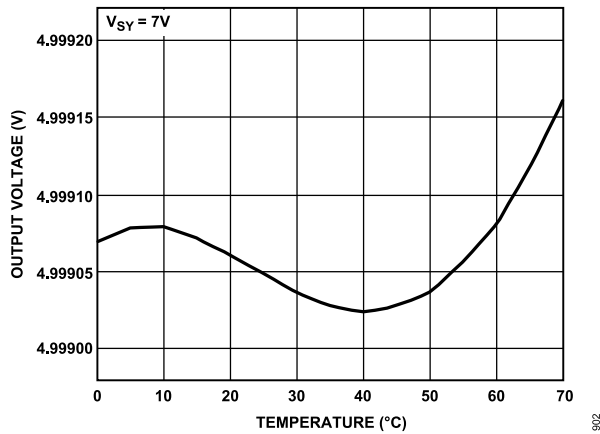

Figure 87. ADR4550 C Grade Output Voltage vs. Temperature

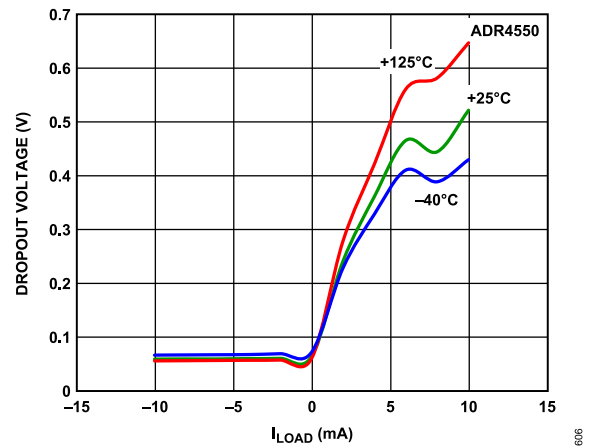

Figure 90. ADR4550 Dropout Voltage vs. Load Current

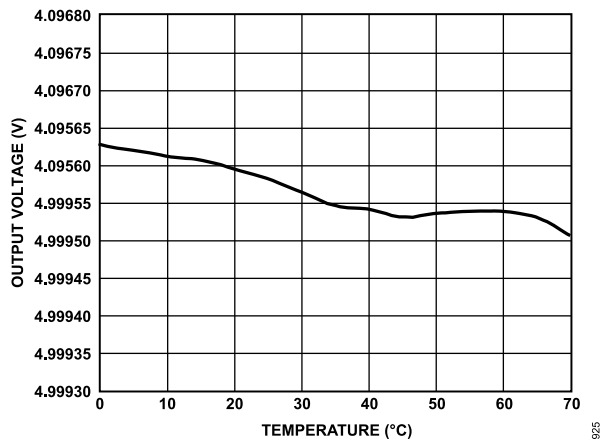

Figure 88. ADR4550 D Grade Output Voltage vs. Temperature

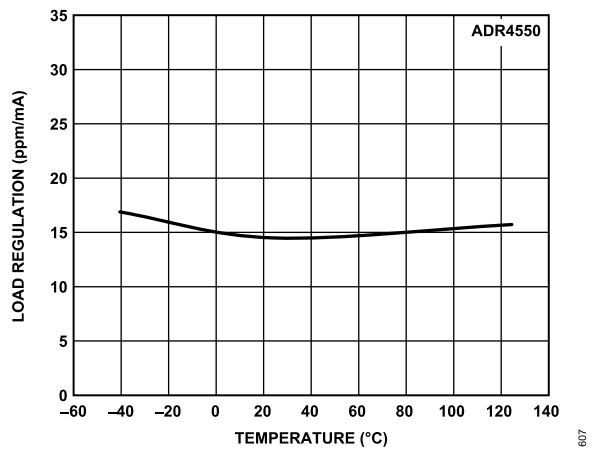

Figure 91. ADR4550 Load Regulation vs. Temperature (Sourcing)

TYPICAL PERFORMANCE CHARACTERISTICS

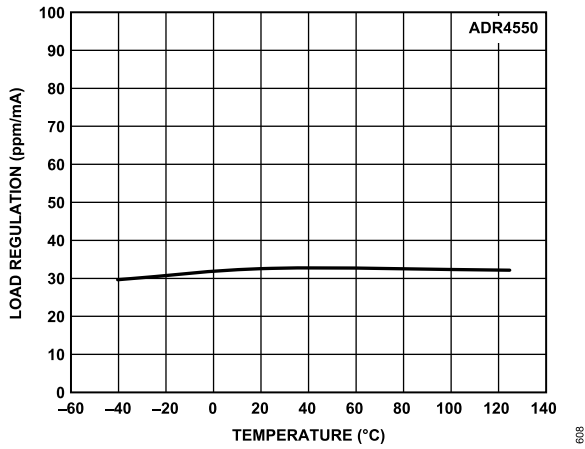

Figure 92. ADR4550 Load Regulation vs. Temperature (Sinking)

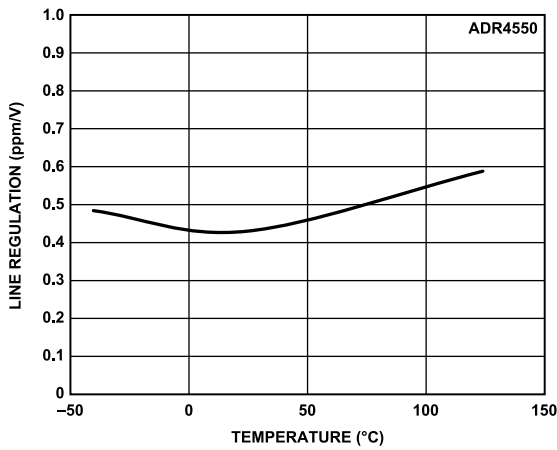

Figure 93. ADR4550 Line Regulation vs. Temperature

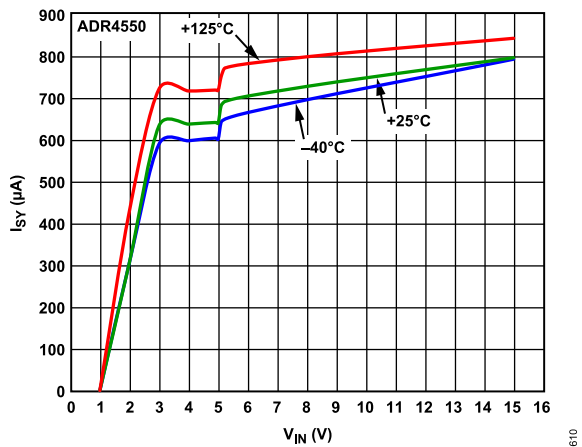

Figure 94. ADR4550 Supply Current vs. Supply Voltage

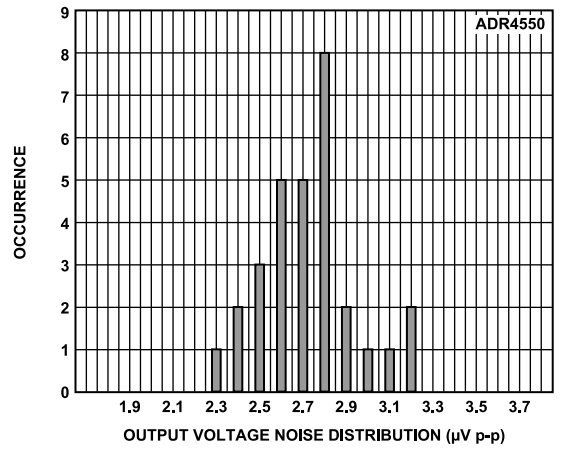

Figure 95. ADR4550 Output Voltage Noise (Maximum Amplitude from 0.1 Hz to 10 Hz)

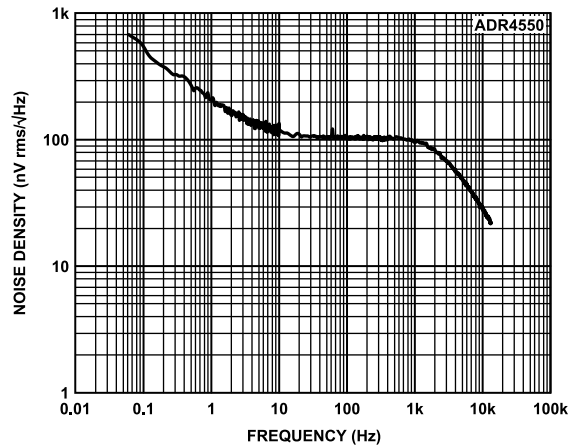

Figure 96. ADR4550 Output Noise Spectral Density

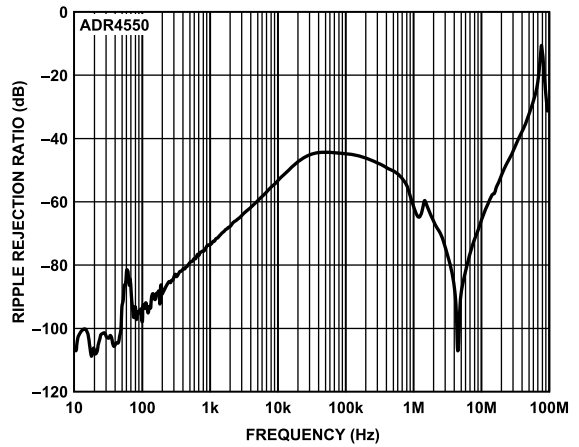

Figure 97. ADR4550 Ripple Rejection Ratio vs. Frequency

TYPICAL PERFORMANCE CHARACTERISTICS

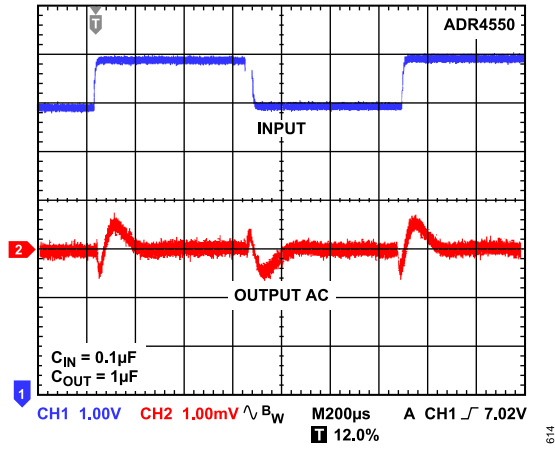

Figure 98. ADR4550 Line Transient Response

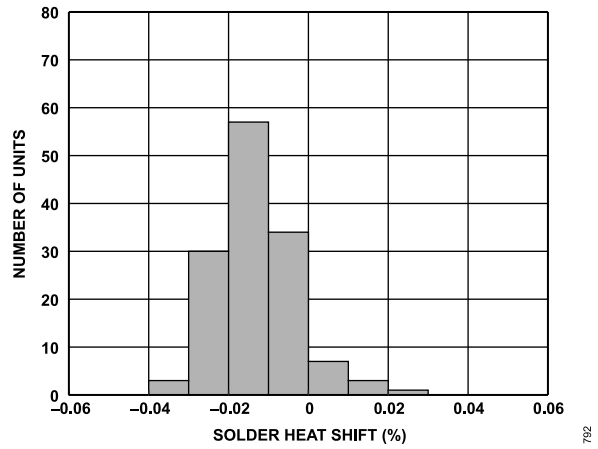

Figure 101. ADR4550 Solder Heat Resistance Shift (3 × Reflow)

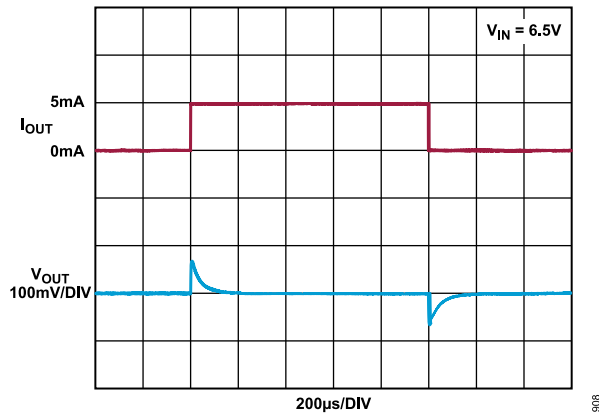

Figure 99. ADR4550 A, B, and C Grades Load Transient Response (Sinking)

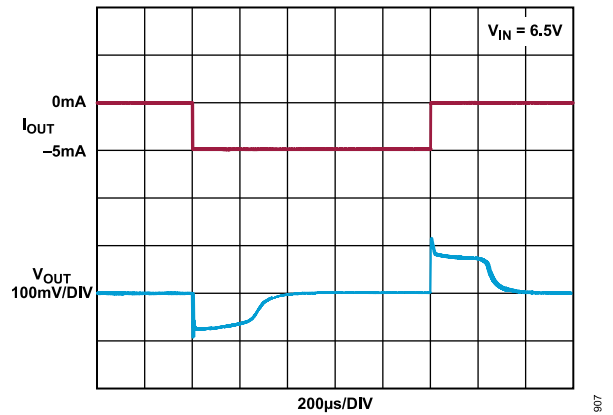

Figure 102. ADR4550 A, B, and C Grades Load Transient Response (Sourcing)

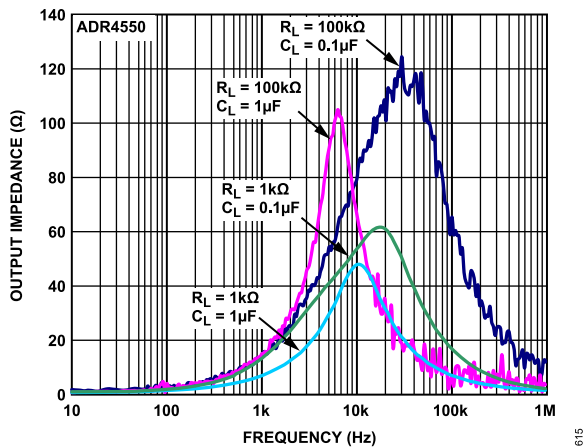

Figure 100. ADR4550 Output Impedance vs. Frequency

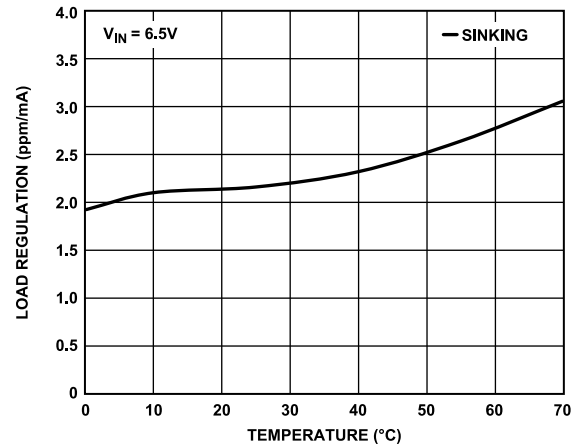

Figure 103. ADR4550 D Grade Load Regulation (Sinking)

TYPICAL PERFORMANCE CHARACTERISTICS

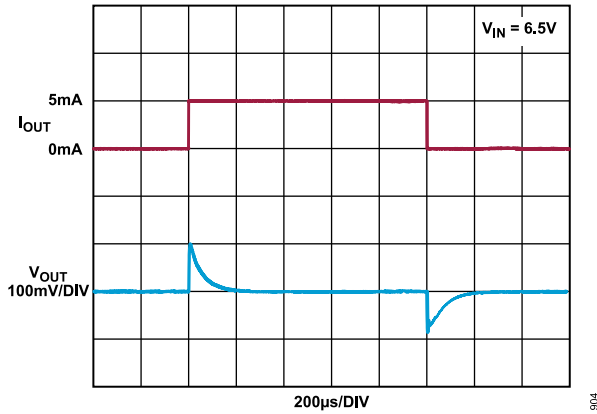

Figure 104. ADR4550 D Grade Load Transient Response (Sinking)

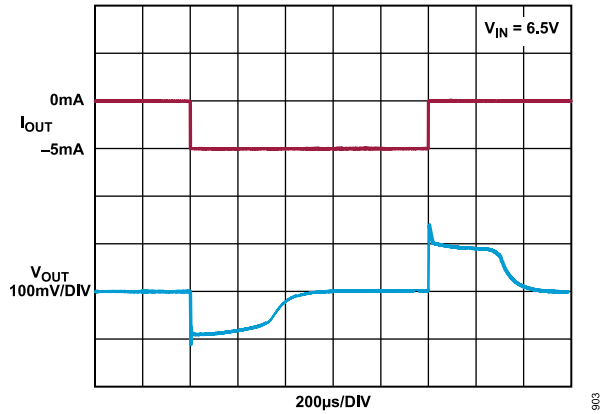

Figure 106. ADR4550 D Grade Load Transient Response (Sourcing)

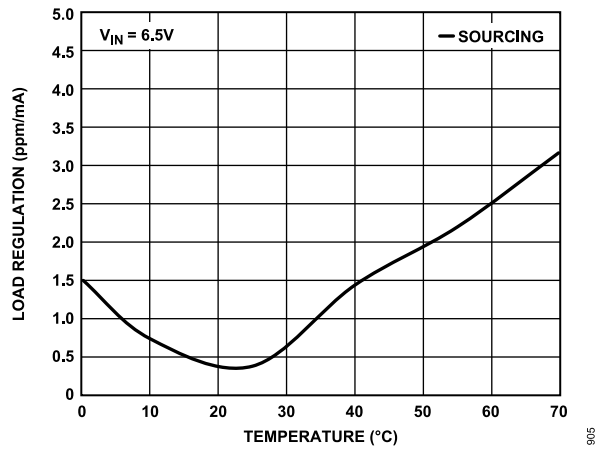

Figure 105. ADR4550 D Grade Load Regulation (Sourcing)

TERMINOLOGY**Dropout Voltage (V_{DO})**

Dropout voltage, sometimes referred to as supply voltage headroom or supply output voltage differential, is defined as the minimum voltage differential between the input and output such that the output voltage is maintained to within 0.1% accuracy.

$$V_{DO} = (V_{IN} - V_{OUT})_{min}|_L = \text{constant}$$

Because the dropout voltage depends on the current passing through the device, it is always specified for a given load current. In series mode devices, the dropout voltage typically increases proportionally to the load current (see [Figure 7](#), [Figure 22](#), [Figure 41](#), [Figure 54](#), [Figure 69](#), and [Figure 90](#)).

Line Regulation

Line regulation refers to the change in output voltage in response to a given change in input voltage and is expressed in percent per volt, ppm per volt, or μV per volt change in input voltage. This parameter accounts for the effects of self heating.

Load Regulation

Load regulation refers to the change in output voltage in response to a given change in load current and is expressed in μV per mA, ppm per mA, or ohms of dc output resistance. This parameter accounts for the effects of self heating.

Solder Heat Resistance (SHR) Shift

SHR shift refers to the permanent shift in output voltage that is induced by exposure to reflow soldering and is expressed as a percentage of the output voltage. This shift is caused by changes in the stress exhibited on the die by the package materials when these materials are exposed to high temperatures. This effect is more pronounced in lead-free soldering processes due to higher reflow temperatures. SHR is calculated after three solder reflow cycles to simulate the worst case conditions when assembling a two-sided PCB with surface mount components with one additional rework cycle. The reflow cycles use the JEDEC standard reflow temperature profile.

Temperature Coefficient (TCV_{OUT})

The temperature coefficient relates the change in the output voltage to the change in the ambient temperature of the device, as normalized by the output voltage at 25°C. The TCV_{OUT} for the ADR4520/ADR4525/ADR4530/ADR4533/ADR4540/ADR4550 A grade and B grade is fully tested over three temperatures: -40°C, +25°C, and +125°C. The TCV_{OUT} for the C grade and D grade is fully tested over three temperatures: 0°C, +25°C, and +70°C. This parameter is specified using two methods. The box method is the most common method and accounts for the temperature coefficient over the full temperature range, whereas the bowtie method calculates

the worst case slope from +25°C and is therefore more useful for systems which are calibrated at +25°C.

Box Method

The box method is represented by the following equation:

$$TCV_{OUT} = \left| \frac{\max\{V_{OUT}(T_1, T_2, T_3)\} - \min\{V_{OUT}(T_1, T_2, T_3)\}}{V_{OUT}(T_2) \times (T_3 - T_1)} \right| \times 10^6$$

where:

TCV_{OUT} is expressed in ppm/°C.

$V_{OUT}(T_X)$ is the output voltage at Temperature T_X .

$T_1 = -40^\circ\text{C}$.

$T_2 = +25^\circ\text{C}$.

$T_3 = +125^\circ\text{C}$.

This box method ensures that TCV_{OUT} accurately portrays the maximum difference between any of the three temperatures at which the output voltage of the device is measured.

Bowtie Method

The bowtie method is represented by the following equation:

$$TCV_{OUT} = |\max\{TCV_{OUT1}, TCV_{OUT2}\}|$$

where:

$$TCV_{V_{OUT1}} = \left| \frac{\max\{V_{OUT}(T_1, T_2)\} - \min\{V_{OUT}(T_1, T_2)\}}{V_{OUT}(T_2) \times (T_2 - T_1)} \right| \times 10^6$$

$$TCV_{V_{OUT2}} = \left| \frac{\max\{V_{OUT}(T_2, T_3)\} - \min\{V_{OUT}(T_2, T_3)\}}{V_{OUT}(T_2) \times (T_3 - T_2)} \right| \times 10^6$$

where:

TCV_{OUT} is expressed in ppm/°C.

$V_{OUT}(T_X)$ is the output voltage at Temperature T_X .

$T_1 = 0^\circ\text{C}$.

$T_2 = +25^\circ\text{C}$.

$T_3 = +70^\circ\text{C}$.

Thermally Induced Output Voltage Hysteresis (ΔV_{OUT_HYS})

Thermally induced output voltage hysteresis represents the change in the output voltage after the device is exposed to a specified temperature cycle. This is expressed as a difference in ppm from the nominal output.

$$\Delta V_{OUT_HYS} = \frac{V_{OUT1_25^\circ\text{C}} - V_{OUT2_25^\circ\text{C}}}{V_{OUT_25^\circ\text{C}}} \times 10^6 [\text{ppm}]$$

where:

$V_{OUT1_25^\circ\text{C}}$ is the output voltage at 25°C.

$V_{OUT2_25^\circ\text{C}}$ is the output voltage after temperature cycling.

TERMINOLOGY**Long-Term Stability (ΔV_{OUT_LTD})**

Long-term stability refers to the shift in the output voltage versus time. This is expressed as a difference in ppm from the nominal output.

$$\Delta V_{OUT_LTD} = \left| \frac{V_{OUT}(t_1) - V_{OUT}(t_0)}{V_{OUT}(t_0)} \right| \times 10^6 \text{ [ppm]}$$

where:

$V_{OUT}(t_0)$ is the V_{OUT} at the starting time of the measurement.

$V_{OUT}(t_1)$ is the V_{OUT} at the end time of the measurement.

APPLICATIONS INFORMATION

BASIC VOLTAGE REFERENCE CONNECTION

The circuit shown in [Figure 107](#) shows the basic configuration for the ADR4520/ADR4525/ADR4530/ADR4533/ADR4540/ADR4550 family of voltage references.

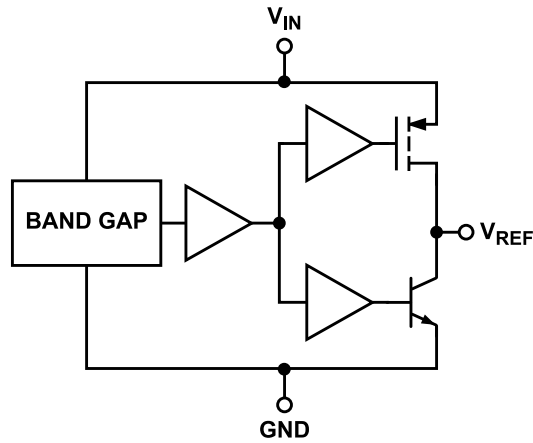

Figure 107. ADR4520/ADR4525/ADR4530/ADR4533/ADR4540/ADR4550
Simplified Schematic

INPUT AND OUTPUT CAPACITORS

Input Capacitors

A 1 μF to 10 μF electrolytic or ceramic capacitor can be connected to the input to improve transient response in applications where the supply voltage may fluctuate. It is recommended to connect an additional 0.1 μF ceramic capacitor in parallel to reduce supply noise.

Output Capacitors

An output capacitor is required for stability and to filter out low level voltage noise. The minimum value of the output capacitor (C_{OUT}) is shown in [Table 11](#).

Table 11. Minimum C_{OUT} Value

Part Number	Minimum C_{OUT} Value
ADR4520, ADR4525	1.0 μF
ADR4530, ADR4533, ADR4540, ADR4550	0.1 μF

An additional 1 μF to 10 μF electrolytic or ceramic capacitor can be added in parallel to improve transient performance in response to sudden changes in load current; however, doing so increases the turn-on time of the device.

LOCATION OF REFERENCE IN SYSTEM

It is recommended to place the ADR4520/ADR4525/ADR4530/ADR4533/ADR4540/ADR4550 reference as close to the load as possible to minimize the length of the output traces and, therefore,

the error introduced by the voltage drop. Current flowing through a PCB trace produces a voltage drop; with longer traces, this drop can reach several millivolts or more, introducing considerable error into the output voltage of the reference. A 1-inch long, 5 mm wide trace of 1-ounce copper has a resistance of approximately 100 m Ω at room temperature; at a load current of 10 mA, this resistance can introduce a full millivolt of error.

POWER DISSIPATION

The ADR4520/ADR4525/ADR4530/ADR4533/ADR4540/ADR4550 voltage references are capable of sourcing and sinking up to 10 mA of load current at room temperature across the rated input voltage range. However, when used in applications subject to high ambient temperatures, the input voltage and load current must be monitored carefully to ensure that the device does not exceed its maximum power dissipation rating. The maximum power dissipation of the device can be calculated using the following equation:

$$P_D = \frac{T_J - T_A}{\theta_{JA}}$$

where:

P_D is the device power dissipation.

T_J is the device junction temperature.

T_A is the ambient temperature.

θ_{JA} is the package (junction to air) thermal resistance.

This relationship can cause acceptable load current in high temperature conditions to be less than the maximum current sourcing capability of the device. Do not operate the device outside of its maximum power rating, because doing so can result in premature failure or permanent damage to the device.

SAMPLE APPLICATIONS

Bipolar Output Reference

[Figure 108](#) shows a bipolar reference configuration. By connecting the output of the ADR4550 to the inverting terminal of an operational amplifier, it is possible to obtain both positive and negative reference voltages. R1 and R2 must be matched as closely as possible to ensure minimal difference between the negative and positive outputs. Resistors with low temperature coefficients must also be used if the circuit is deployed in environments with large temperature swings; otherwise, a voltage difference develops between the two outputs as the ambient temperature changes.

APPLICATIONS INFORMATION

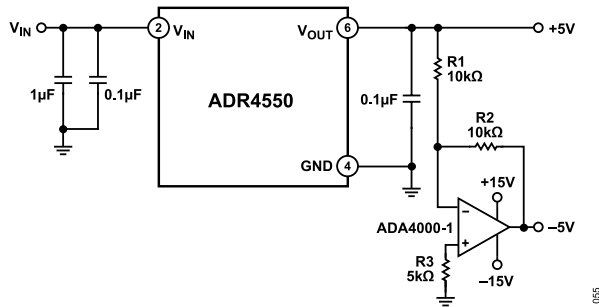

Figure 108. ADR4550 Bipolar Output Reference

Boosted Output Current Reference

Figure 109 shows a configuration for obtaining higher current drive capability from the ADR4520/ADR4525/ADR4530/ADR4533/ADR4540/ADR4550 references without sacrificing accuracy. The op amp regulates the current flow through the metal-oxide semiconductor field effect transistor (MOSFET) until V_{OUT} equals the output voltage of the reference; current is then drawn directly from V_{IN} instead of from the reference itself, allowing increased current drive capability.

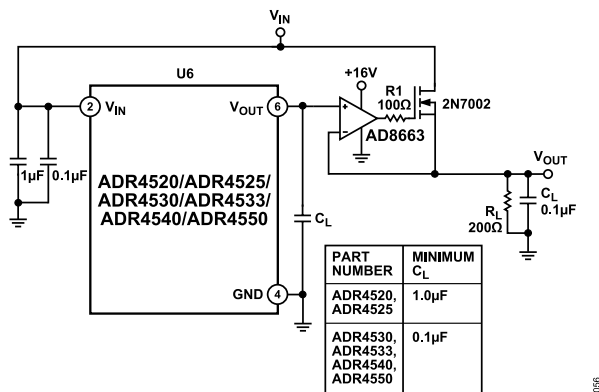

Figure 109. Boosted Output Current Reference

Because the current sourcing capability of this circuit depends only on the current rating of the MOSFET, the output drive capability can be adjusted to the application simply by choosing an appropriate MOSFET. In all cases, tie the V_{OUT} pin directly to the load device to maintain maximum output voltage accuracy.

LONG-TERM DRIFT

The stability of a precision signal path over its lifetime or between calibration procedures is dependent on the long-term stability of the analog components in the path, such as op amps, references, and data converters. To help system designers predict the long-term drift of circuits that use the ADR4520/ADR4525/ADR4530/ADR4533/ADR4540/ADR4550, Analog Devices measured the output voltage of multiple units for more than 4500 hours (more than 6 months) using a high precision measurement system, including an

ultrastable oil bath. To replicate real-world system performance, the devices under test (DUTs) were soldered onto an FR4 PCB using a standard reflow profile (as defined in the JEDEC J-STD-020D standard), rather than testing them in sockets. This manner of testing is important because expansion and contraction of the PCB can apply stress to the integrated circuit (IC) package and contribute to shifts in the offset voltage.

Figure 110 shows the long-term drift of the ADR4520/ADR4525/ADR4530/ADR4533/ADR4540/ADR4550. Sample 1, Sample 2, and Sample 3 plot traces show sample units. The mean drift after 4500 hours is 51 ppm. Note that the early life drift (0 hours to 250 hours) accounts for 40% of the total drift observed over 4500 hours, as shown in Figure 111. The first 1000 hours account for 50% of the total drift, and the remaining 3500 hours account for the remaining 50% of the drift. Thus, the early life drift is the dominant contributor, whereas the drift after 1000 hours is significantly lower.

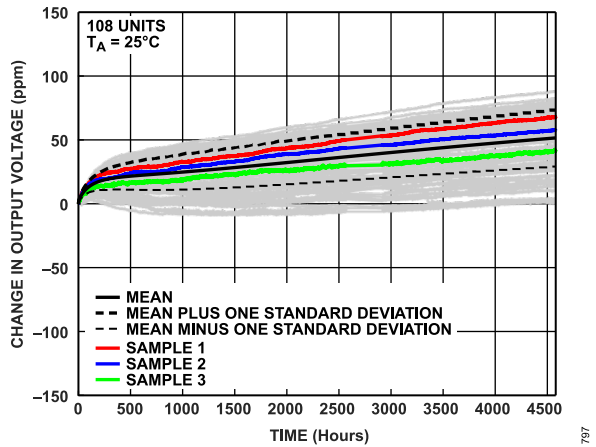

Figure 110. Measured Long-Term Drift of the ADR4520/ADR4525/ADR4530/ADR4533/ADR4540/ADR4550 over 4,500 Hours

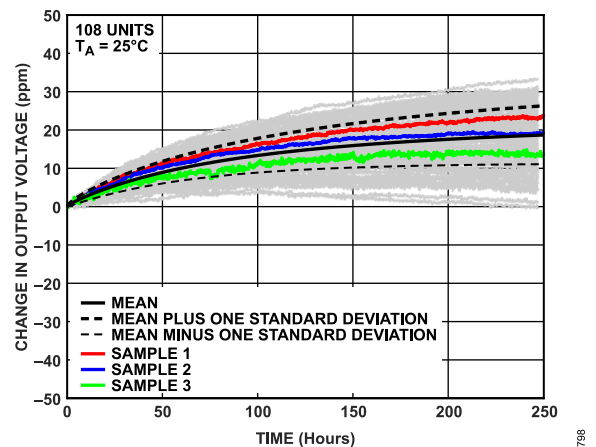

Figure 111. Measured Early Life Drift of the ADR4520/ADR4525/ADR4530/ADR4533/ADR4540/ADR4550

APPLICATIONS INFORMATION

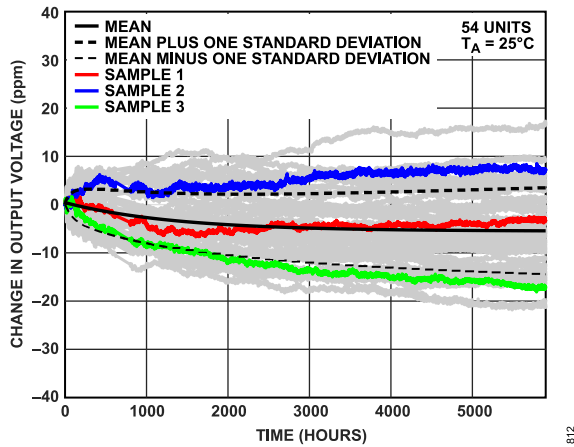

Figure 112. Measured Long-Term Drift of the ADR4525D/ADR4540D/ADR4550D over 4,500 Hours

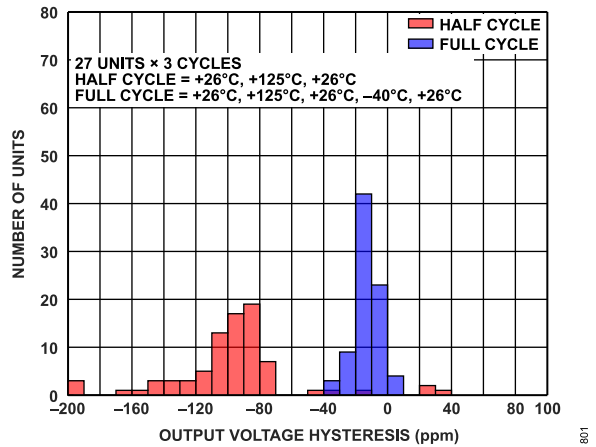

Figure 114. Histogram Showing the Temperature Hysteresis of the Output Voltage (-40°C to +125°C)

THERMAL HYSTERESIS

In addition to stability over time, as described in the [Long-Term Drift](#) section, it is useful to know the thermal hysteresis, that is, the stability vs. cycling of temperature. Thermal hysteresis is an important parameter because it tells the system designer how closely the signal returns to its starting amplitude after the ambient temperature changes and the subsequent return to room temperature. [Figure 113](#) shows the change in output voltage as the temperature cycles three times from room temperature to +125°C to -40°C and back to room temperature.

In the three full cycles, the output hysteresis is typically -13 ppm. The histogram in [Figure 114](#) shows that the hysteresis is larger when the device is cycled through only a half cycle, from room temperature to 125°C and back to room temperature, typically -97 ppm.

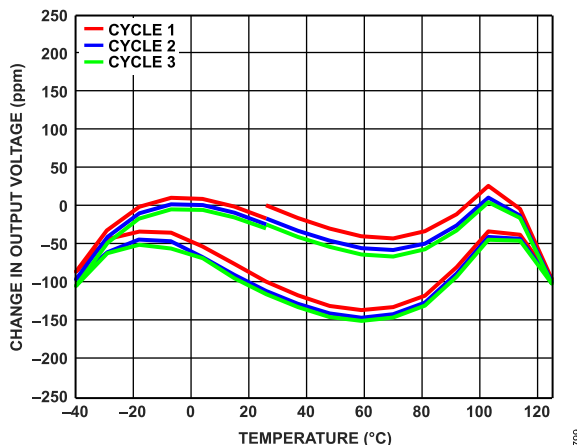

Figure 113. Change in Output Voltage over Three Full Temperature Cycles (-40°C to +125°C)

[Figure 115](#) shows the change in input offset voltage as the temperature cycles three times from room temperature to +70°C to 0°C and back to room temperature. In the three full cycles, the output hysteresis is typically -8 ppm. The histogram in [Figure 116](#) shows that the hysteresis is larger when the device is cycled through only a half cycle, from room temperature to +70°C and back to room temperature, typically -17 ppm.

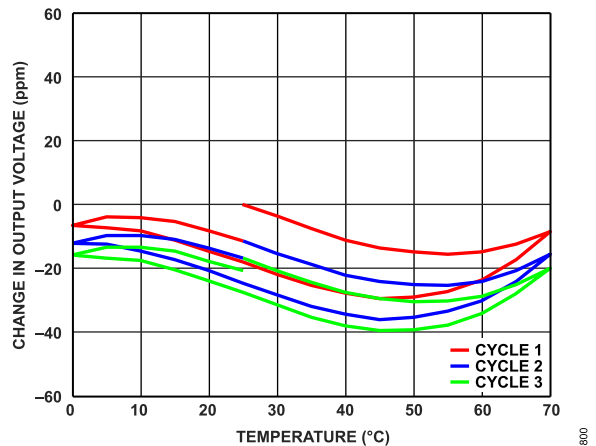

Figure 115. Change in Output Voltage over Three Full Temperature Cycles (0°C to 70°C)

APPLICATIONS INFORMATION

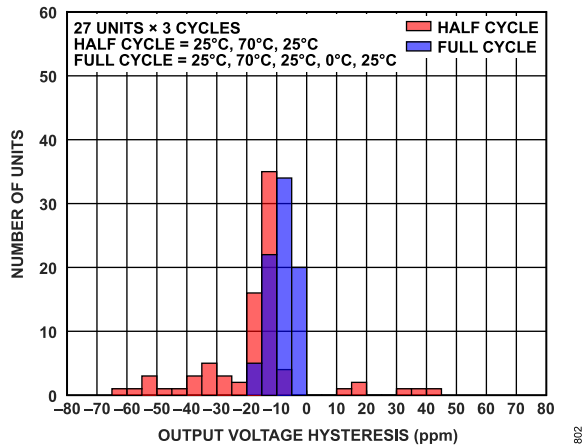

Figure 116. Histogram Showing the Temperature Hysteresis of the Output Voltage (0°C to 70°C)

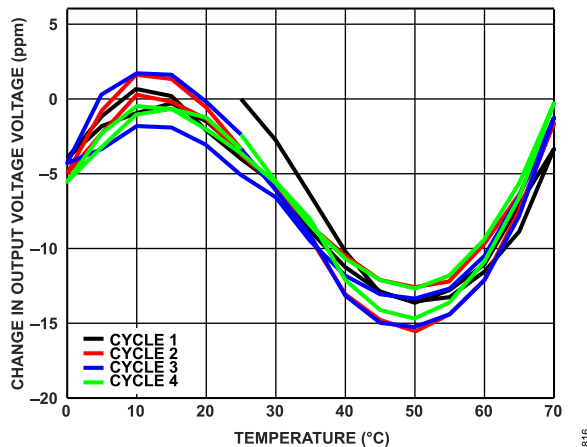

Figure 117. D Grade Change in Output Voltage over Three Full Temperature Cycles (0°C to 70°C)

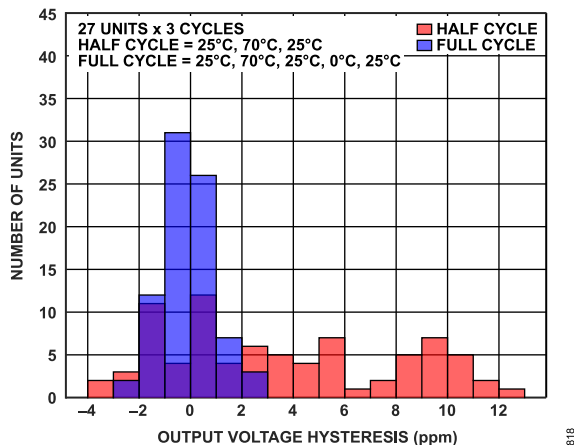

Figure 118. D Grade Histogram Showing the Temperature Hysteresis of the Output Voltage (0°C to 70°C)

Measuring thermal hysteresis over the full operating temperature range is not reflective of a typical operating environment in most applications. Instead, smaller temperature variations are more normal. The ADR4520/ADR4525/ADR4530/ADR4533/ADR4540/ADR4550 were tested over 20 different temperature cycles of increasing magnitude, centered at +25°C, starting with +25°C ± 5°C and going up to the full operating temperature range of -40°C to +125°C. The results are shown in Figure 119.

For a temperature delta of 100°C (that is, +25°C ± 50°C) the thermal hysteresis is less than 20 ppm for both the full cycle and the half cycle. Above this range, the thermal hysteresis increases significantly. These results show that the standard specification, which covers the full operating temperature range, is close to the worst case performance.

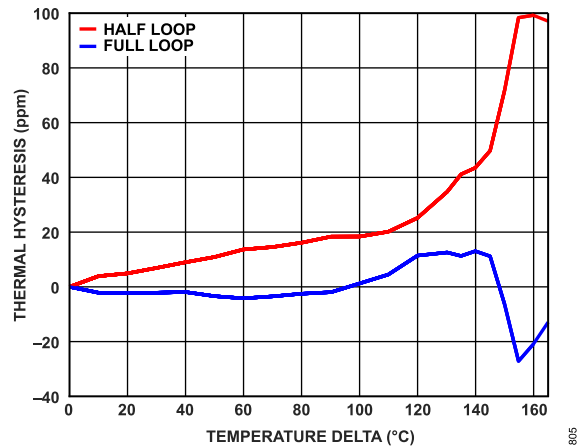

Figure 119. Thermal Hysteresis for Increasing Temperature Range

HUMIDITY SENSITIVITY

The ADR4520/ADR4525/ADR4530/ADR4533/ADR4540/ADR4550 is packaged in a SOIC plastic package and has a moisture sensitivity level of MSL-1, per the JEDEC standard. However, moisture absorption from the air into the package changes the internal mechanical stresses on the die causing shifts in the output voltage. Figure 120 shows the effects of a step change in relative humidity on the output voltage over time.

The humidity chamber is maintained at an ambient temperature of +25°C, while the relative humidity undergoes a step change from 20% to 80% at time zero. The relative humidity is maintained at 80% for the duration of the testing. Note that the output voltage shifts quickly compared to the overall settling time, following the step change in relative humidity.

Figure 121 shows the effects of 10% increases in relative humidity from 30% to 70% and back to 30%. Note that after the relative humidity returns to 30%, the output voltage is settling back to its starting point.

APPLICATIONS INFORMATION

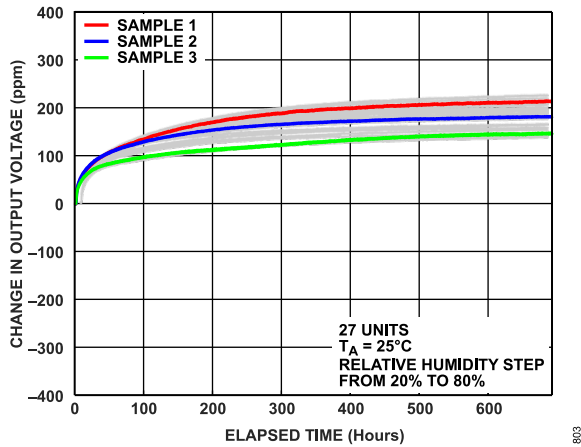

Figure 120. Change in Output Voltage vs. Time After Humidity Step Change (20% to 80% Relative Humidity)

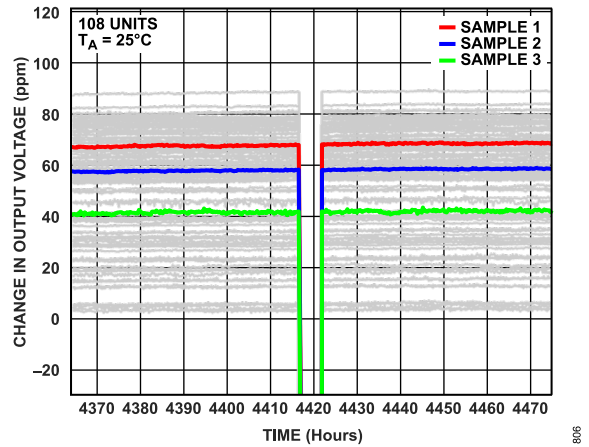

Figure 122. Power Cycle Hysteresis

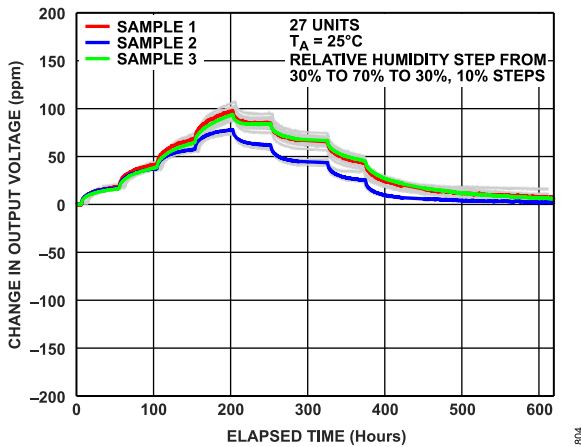

Figure 121. Change in Output Voltage vs. Time for 10% Humidity Steps (30% to 70% to 30% Relative Humidity in 10% Steps)

POWER CYCLE HYSTERESIS

By power cycling large numbers of samples, the power cycle hysteresis can be determined. To keep this measurement independent of other variables and environmental effects, the power cycle testing was performed using a high precision measurement system, including an ultrastable oil bath.

Figure 122 shows the power cycle hysteresis. The units were powered down for approximately four hours and then powered up. The ADR4520/ADR4525/ADR4530/ADR4533/ADR4540/ADR4550 do not have any power cycle hysteresis even after a long power-down period, making these devices very suitable for equipment which must maintain its calibration accuracy between power cycles.

SELECTION GUIDE AND VOLTAGE REFERENCE CHOICES

Table 12. Selection Guide

Model	Output Voltage (V)	Grade
ADR4520	2.048	A, B
ADR4525	2.5	A, B, C, D
ADR4525W	2.5	B
ADR4530	3.0	A, B
ADR4533	3.3	A, B
ADR4540	4.096	A, B, C, D
ADR4550	5.0	A, B, C, D

Table 13. Voltage Reference Choices from Analog Devices, Inc.

V _{OUT} (V)	Micropower	Low Power	Ultralow Noise
2.048	ADR3420 LT6656	ADR360 LTC6652 LT6654	ADR440 LTC6655
2.5	ADR3425 LT1461 LT6656	ADR361 LTC6652 LT6654	ADR441 LTC6655
5.0	ADR3450 LT1461 LT6656	ADR365 LTC6652 LT6654	ADR445 LTC6655

OUTLINE DIMENSIONS

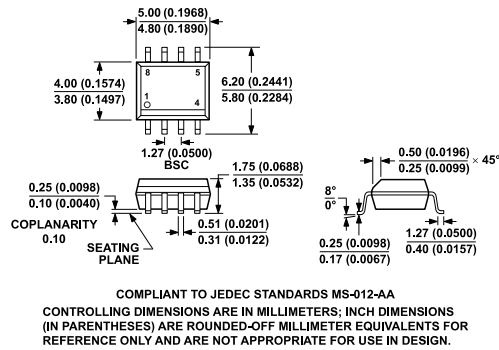

**Figure 123. 8-Lead Standard Small Outline Package [SOIC_N]
Narrow Body
(R-8)
Dimensions shown in millimeters and (inches)**

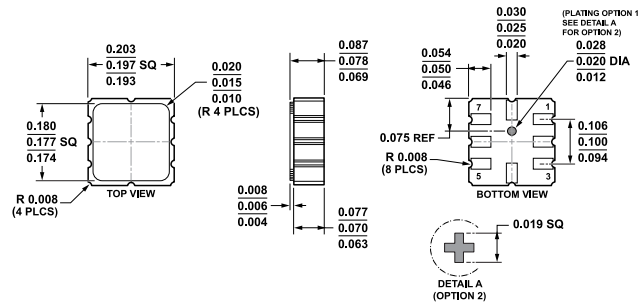

**Figure 124. 8-Terminal Ceramic Leadless Chip Carrier [LCC]
(E-8-1)
Dimensions shown in inches**

Updated: April 21, 2023

ORDERING GUIDE

Model ^{1,2}	Temperature Range	Package Description	Packing Quantity	Package Option
ADR4520ARZ	-40°C to +125°C	8-Lead SOIC		R-8
ADR4520ARZ-R7	-40°C to +125°C	8-Lead SOIC	Reel, 1000	R-8
ADR4520BRZ	-40°C to +125°C	8-Lead SOIC		R-8
ADR4520BRZ-R7	-40°C to +125°C	8-Lead SOIC	Reel, 1000	R-8
ADR4525ARZ	-40°C to +125°C	8-Lead SOIC		R-8
ADR4525ARZ-R7	-40°C to +125°C	8-Lead SOIC	Reel, 1000	R-8
ADR4525BRZ	-40°C to +125°C	8-Lead SOIC		R-8
ADR4525BRZ-R7	-40°C to +125°C	8-Lead SOIC	Reel, 1000	R-8
ADR4525CRZ	0°C to +70°C	8-Lead SOIC		R-8
ADR4525CRZ-R7	0°C to +70°C	8-Lead SOIC	Reel, 1000	R-8
ADR4525DEZ	0°C to +70°C	LCC:CER LEADLESS CHIP CARR		E-8
ADR4525DEZ-R7	0°C to +70°C	LCC:CER LEADLESS CHIP CARR	Reel, 250	E-8
ADR4525WBRZ-R7	-40°C to +125°C	8-Lead SOIC	Reel, 1000	R-8
ADR4530ARZ	-40°C to +125°C	8-Lead SOIC		R-8
ADR4530ARZ-R7	-40°C to +125°C	8-Lead SOIC	Reel, 1000	R-8

OUTLINE DIMENSIONS

Model ^{1,2}	Temperature Range	Package Description	Packing Quantity	Package Option
ADR4530BRZ	-40°C to +125°C	8-Lead SOIC		R-8
ADR4530BRZ-R7	-40°C to +125°C	8-Lead SOIC	Reel, 1000	R-8
ADR4533ARZ	-40°C to +125°C	8-Lead SOIC		R-8
ADR4533ARZ-R7	-40°C to +125°C	8-Lead SOIC	Reel, 1000	R-8
ADR4533BRZ	-40°C to +125°C	8-Lead SOIC		R-8
ADR4533BRZ-R7	-40°C to +125°C	8-Lead SOIC	Reel, 1000	R-8
ADR4540ARZ	-40°C to +125°C	8-Lead SOIC		R-8
ADR4540ARZ-R7	-40°C to +125°C	8-Lead SOIC	Reel, 1000	R-8
ADR4540BRZ	-40°C to +125°C	8-Lead SOIC		R-8
ADR4540BRZ-R7	-40°C to +125°C	8-Lead SOIC	Reel, 1000	R-8
ADR4540CRZ	0°C to +70°C	8-Lead SOIC		R-8
ADR4540CRZ-R7	0°C to +70°C	8-Lead SOIC	Reel, 1000	R-8
ADR4540DEZ	0°C to +70°C	LCC:CER LEADLESS CHIP CARR		E-8
ADR4540DEZ-R7	0°C to +70°C	LCC:CER LEADLESS CHIP CARR	Reel, 250	E-8
ADR4550ARZ	-40°C to +125°C	8-Lead SOIC		R-8
ADR4550ARZ-R7	-40°C to +125°C	8-Lead SOIC	Reel, 1000	R-8
ADR4550BRZ	-40°C to +125°C	8-Lead SOIC		R-8
ADR4550BRZ-R7	-40°C to +125°C	8-Lead SOIC	Reel, 1000	R-8
ADR4550CRZ	0°C to +70°C	8-Lead SOIC		R-8
ADR4550CRZ-R7	0°C to +70°C	8-Lead SOIC	Reel, 1000	R-8
ADR4550DEZ	0°C to +70°C	LCC:CER LEADLESS CHIP CARR		E-8
ADR4550DEZ-R7	0°C to +70°C	LCC:CER LEADLESS CHIP CARR	Reel, 1000	E-8

¹ Z = RoHS Compliant Part.

² W = Qualified for Automotive Applications.

AUTOMOTIVE PRODUCTS

The ADR4525W model is available with controlled manufacturing to support the quality and reliability requirements of automotive applications. Note that this automotive model may have specifications that differ from the commercial models; therefore, designers should review the [Specifications](#) section of this data sheet carefully. Only the automotive grade product shown is available for use in automotive applications. Contact your local Analog Devices account representative for specific product ordering information and to obtain the specific Automotive Reliability reports for this model.