

DATA SHEET

ARRAY CHIP RESISTORS

YC/TC

5%, 1%

sizes

YC: 102/104/122/124/162/164/248/324/158T/358L/358T

TC: 122/124/164

RoHS compliant



SCOPE

This specification describes YC (convex, flat) and TC (concave) series chip resistor arrays with lead-free terminations made by thick film process.

APPLICATIONS

- Terminal for SDRAM and DDRAM
- Computer applications: laptop computer, desktop computer
- Consume electronic equipments: PDAs, PNDs
- Mobile phone, telecom...

FEATURES

- AEC-Q200 qualified
- More efficient in pick & place application
- Low assembly costs
- RoHS compliant
- Products with lead free terminations meet RoHS requirements
- Pb-glass contained in electrodes
- Resistor element and glass are exempted by RoHS
- Reducing environmentally hazardous wastes
- High component and equipment reliability
- Saving of PCB space
- None forbidden-materials used in products/production
- Halogen Free Epoxy
- MSL class: MSL I

ORDERING EXAMPLE

The ordering code of a YC122 convex chip resistor array, value 1,000 Ω with $\pm 5\%$ tolerance, supplied in 7-inch tape reel is: YC122-JR-071KL.

YC158T network, value 100,000 Ω with 5% tolerance, supplied in 7-inch tape reel is: YC158TJR-07100KL

NOTE

1. All our RSMD products meet RoHS compliant. "LFP" of the internal 2D reel label mentions "Lead Free Process"
2. On customized label, "LFP" or specific symbol printed and the optional "L" at the end of GLOBAL PART NUMBER

ORDERING INFORMATION - GLOBAL PART NUMBER & I2NC

Both part numbers are identified by the series, size, tolerance, packing type, temperature coefficient, taping reel and resistance value.

YAGEO BRAND ordering code

GLOBAL PART NUMBER (PREFERSRED)

YC	XXXX	X	X	X	X	XX	XXXX	L/T
TC	(1)	(2)	(3)	(4)	(5)	(6)	(7)	(8)

(1) SIZE

YC: 102/104/122/124/162/164/248/324/158T/358L/358T

TC: 122/124/164

(2) ARRAYS OR NETWORKS

Array YC102/104/122/124/162/164/248/324: -

Network YC158T/YC358L/YC358T: NA

(3) TOLERANCE

F = $\pm 1\%$

J = $\pm 5\%$ (for Jumper ordering, use code of J)

(4) PACKAGING TYPE

R = Paper taping reel K = Embossed plastic tape reel

(5) TEMPERATURE COEFFICIENT OF RESISTANCE

- = Base on spec

(6) TAPING REEL

07 = 7 inch dia. Reel

13 = 13 inch dia. Reel

(7) RESISTANCE VALUE

There are 2~4 digits indicated the resistor value. Letter R/K/M is decimal point.

Detailed resistance rules show in table of "Resistance rule of global part number".

(8) DEFAULT CODE

Letter L is the system default code for ordering only. (Note)

Letter T is the only default code for YC102.

Resistance rule of global part number	
Resistance code rule	Example
OR	OR = Jumper
XXXX (1 to 97.6 Ω)	IR = 1 Ω IR5 = 1.5 Ω 9R76 = 97.6 Ω
XXRX (10 to 97.6 Ω)	10R = 10 Ω 97R6 = 97.6 Ω
XXXR (100 to 976 Ω)	100R = 100 Ω
XKXX (1 to 97.6 K Ω)	1K = 1,000 Ω 9K76 = 9760 Ω
XM (1 M Ω)	1M = 1,000,000 Ω

MARKING

YCI02



YCI22

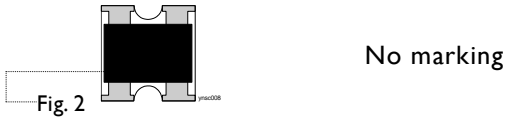

YCI04

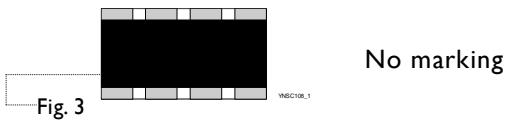

YCI24 / 162 / 164 / 324

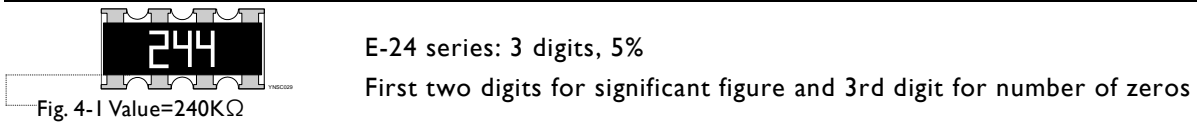
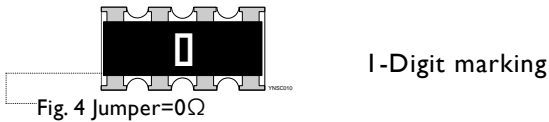

YC248

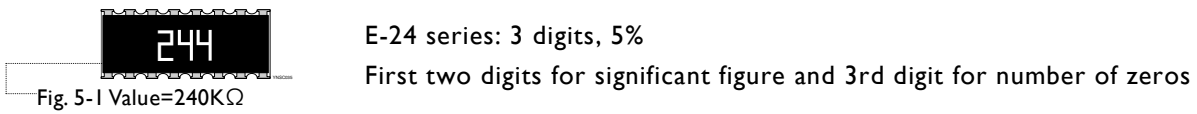
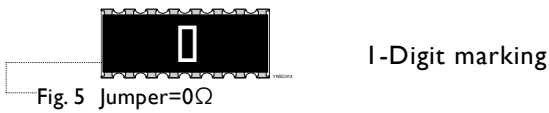

YCI58T/358L/358T



TCI22



TCI24

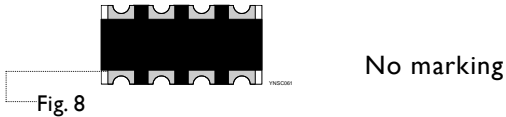

TCI64

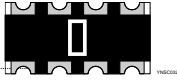

I-Digit marking

Fig. 9 Jumper=0Ω



E-24 series: 3 digits, 5%
First two digits for significant figure and 3rd digit for number of zeros

Fig. 9-I Value=240KΩ

For further marking information, please refer to data sheet “Chip resistors marking”.

CONSTRUCTION

The resistor is constructed on top of a high-grade ceramic body. Internal metal electrodes are added on each end to make the contacts to the thick film resistive element. The composition of the resistive element is a noble metal imbedded into a glass and covered by a second glass to prevent environment influences. The resistor is laser trimmed to the rated resistance value. The resistor is covered with a protective epoxy coat, finally the two external terminations (matte tin on Ni-barrier) are added as shown in Fig.10.

OUTLINES

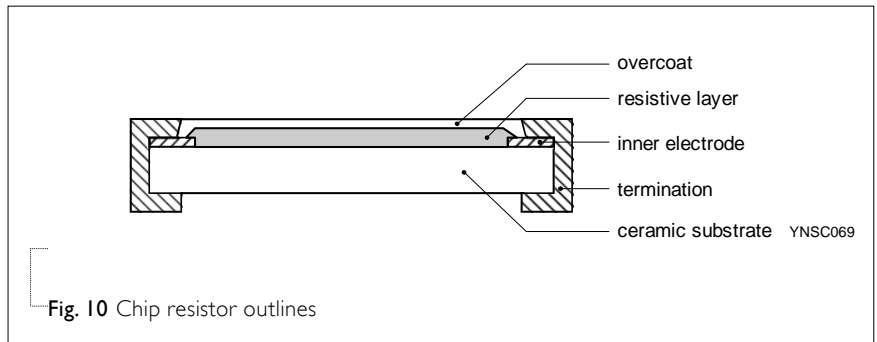
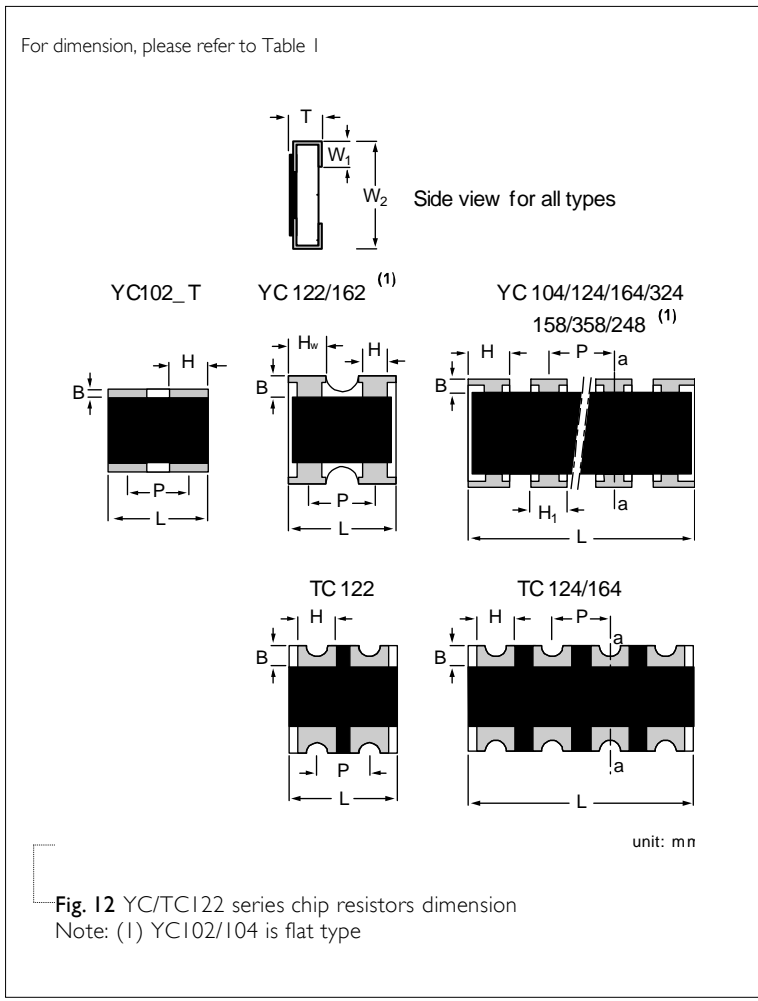
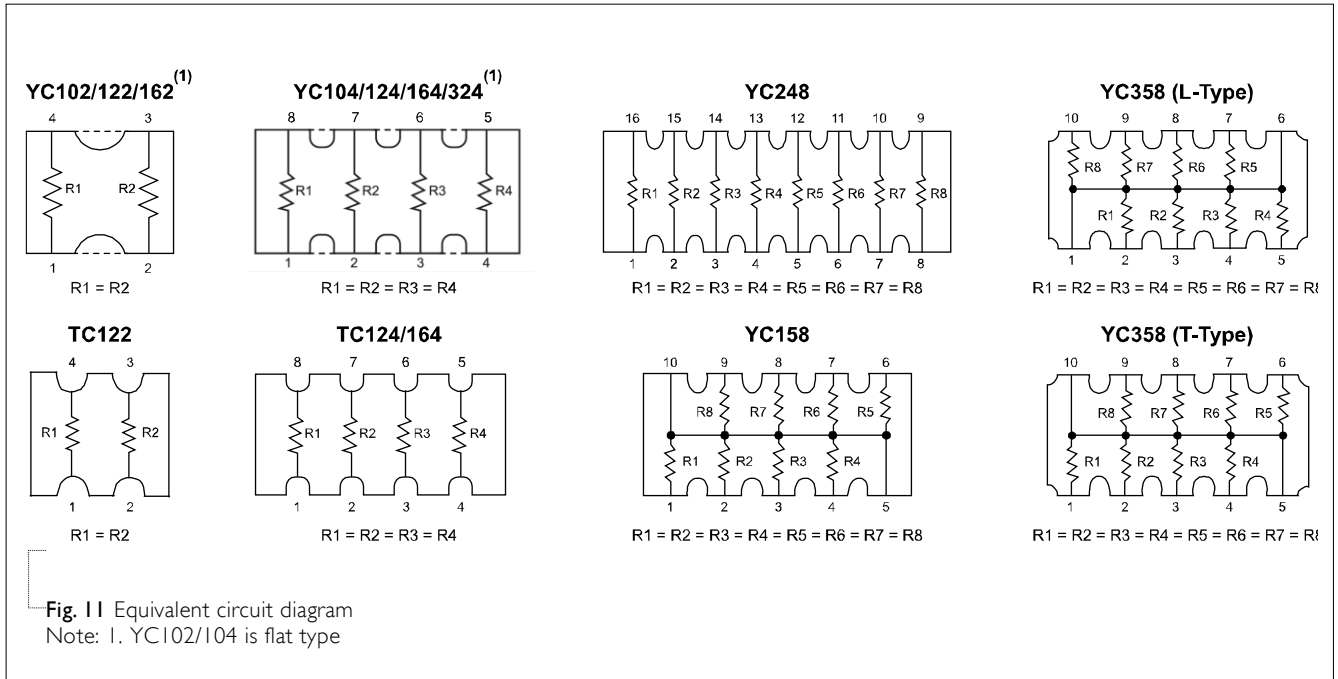

Fig. 10 Chip resistor outlines

SCHEMATIC



DIMENSIONS

Table I

TYPE	H / H _I / H _W	B	P	L	T	W1	W2
YCI02	H: 0.25±0.10	0.15±0.10	0.55±0.10	0.80±0.10	0.35±0.10	0.15±0.10	0.60±0.10
YCI04	H: 0.20±0.10	0.15±0.05	0.40±0.10	1.40±0.10	0.35±0.10	0.15±0.10	0.60±0.10
YCI22	H: 0.210.10 / -0.05 H _W : 0.35±0.10	0.20±0.10	0.67±0.05	1.00±0.10	0.30±0.10	0.25±0.10	1.00±0.10
YCI24	H: 0.40±0.15 H _I : 0.30±0.05	0.20±0.15	0.50±0.05	2.00±0.10	0.45±0.10	0.30±0.15	1.00±0.10
YCI62	H: 0.30±0.10 H _W : 0.65±0.15	0.30±0.10	0.80±0.05	1.60±0.10	0.40±0.10	0.30±0.10	1.60±0.10
YCI64	H: 0.65±0.05 H _I : 0.50±0.15	0.30±0.15	0.80±0.05	3.20±0.15	0.60±0.10	0.30±0.15	1.60±0.15
YC248	H: 0.45±0.05 H _I : 0.30±0.05	0.30±0.15	0.50±0.05	4.00±0.20	0.45±0.10	0.40±0.15	1.60±0.15
YC324	H: 1.10±0.15 H _I : 0.90±0.15	0.50±0.20	1.27±0.05	5.08±0.20	0.60±0.10	0.50±0.15	3.20±0.20
TCI22	H: 0.30±0.05	0.25±0.15	0.50±0.05	1.00±0.10	0.30±0.10	0.25±0.15	1.00±0.10
TCI24	H: 0.30±0.10	0.20±0.10	0.50±0.05	2.00±0.10	0.40±0.10	0.25±0.10	1.00±0.10
TCI64	H: 0.50±0.15	0.30±0.15	0.80±0.05	3.20±0.15	0.60±0.10	0.30±0.15	1.60±0.15
YCI58T	H: 0.45±0.05 H _I : 0.32±0.05	0.30±0.15	0.64±0.05	3.20±0.20	0.60±0.10	0.35±0.15	1.60±0.15
YC358L YC358T	H: 1.10±0.15 H _I : 0.90±0.15	0.50±0.15	1.27±0.05	6.40±0.20	0.60±0.10	0.50±0.15	3.20±0.20

ELECTRICAL CHARACTERISTICS

Table 2

TYPE	POWER P ₇₀	OPERATING TEMP. RANGE	MWV	RCOV	DWV	RESISTANCE RANGE & TOLERANCE	T. C. R.	Jumper criteria (unit: A)
YC102	1/32W	-55°C to +125°C	15V	30V	30V	E24 ±5% 10Ω ≤ R ≤ 1MΩ E24/E96 ±1% 10Ω ≤ R ≤ 1MΩ Jumper < 0.05Ω	±200 ppm/°C	Rated current 0.5 Max. current 1.0
YC104	1/32W	-55°C to +125°C	12.5V	25V	25V	E24 ±5% 10Ω ≤ R ≤ 1MΩ E24/E96 ±1% 10Ω ≤ R ≤ 1MΩ Jumper < 0.05Ω		Rated current 0.5 Max. current 1.0
YC122	1/16W	-55°C to +155°C	50V	100V	100V	E24 ±5% 1Ω ≤ R ≤ 1MΩ E24/E96 ±1% 1Ω ≤ R ≤ 1MΩ Jumper < 0.05Ω		Rated current 0.5 Max. current 1.0
YC124	1/16W	-55°C to +155°C	25V	50V	100V	E24 ±5% 1Ω ≤ R ≤ 1MΩ E24/E96 ±1% 1Ω ≤ R ≤ 1MΩ Jumper < 0.05Ω	1Ω ≤ R ≤ 10Ω ±250 ppm/°C 10Ω < R ≤ 1MΩ ±200 ppm/°C	Rated current 1.0 Max. current 2.0
YC162	1/16W	-55°C to +155°C	50V	100V	100V	E24 ±5% 1Ω ≤ R ≤ 1MΩ E24/E96 ±1% 1Ω ≤ R ≤ 1MΩ Jumper < 0.05Ω		Rated current 1.0 Max. current 2.0
YC164	1/16W	-55°C to +155°C	50V	100V	100V	E24 ±5% 1Ω ≤ R ≤ 1MΩ E24/E96 ±1% 1Ω ≤ R ≤ 1MΩ Jumper < 0.05Ω		Rated current 1.0 Max. current 2.0
YC248	1/16W	-55°C to +155°C	50V	100V	100V	E24 ±5% 10Ω ≤ R ≤ 1MΩ E24/E96 ±1% 10Ω ≤ R ≤ 1MΩ Jumper < 0.05Ω		Rated current 2.0 Max. current 10.0
YC324	1/8W	-55°C to +155°C	200V	500V	500V	E24 ±5% 10Ω ≤ R ≤ 1MΩ E24/E96 ±1% 10Ω ≤ R ≤ 1MΩ		---
TC122	1/16W	-55°C to +125°C	50V	100V	100V	E24 ±5% 10Ω ≤ R ≤ 1MΩ E24/E96 ±1% 10Ω ≤ R ≤ 1MΩ Jumper < 0.05Ω	±200 ppm/°C	Rated current 1.0 Max. current 1.5
TC124	1/16W	-55°C to +125°C	50V	100V	100V	E24 ±5% 10Ω ≤ R ≤ 1MΩ E24/E96 ±1% 10Ω ≤ R ≤ 1MΩ Jumper < 0.05Ω		Rated current 1.0 Max. current 1.5
TC164	1/16W	-55°C to +155°C	50V	100V	100V	E24 ±5% 10Ω ≤ R ≤ 1MΩ E24/E96 ±1% 10Ω ≤ R ≤ 1MΩ Jumper < 0.05Ω		Rated current 1.0 Max. current 2.0
YC158T	1/16W	-55°C to +155°C	25V	50V	50V	E24 ±5% 10Ω ≤ R ≤ 100KΩ		---
YC358L YC358T	1/16W	-55°C to +155°C	50V	100V	100V	E24 ±5% 10Ω ≤ R ≤ 330KΩ		---

FOOTPRINT AND SOLDERING PROFILES

For recommended footprint and soldering profiles, please refer to data sheet “Chip resistors mounting”.

PACKING STYLE AND PACKAGING QUANTITY

Table 3 Packing style and packaging quantity

PACKING STYLE	PACKING STYLE	YC102/ 104	YC/TC 122	YC/TC 124	YC162	YC/TC 164	YC248	YC324	YC158T	YC358L YC358T
Paper taping reel (R)	7" (178mm)	10,000	10,000	10,000	5,000	5,000	5,000	---	5,000	---
	13" (254mm)	50,000	50,000	40,000	---	20,000	---	---	20,000	---
Embossed taping reel (K)	7" (178mm)	---	---	---	---	---	4,000	4,000	---	4,000

NOTE

1. For tape and reel specification/dimensions, please refer to data sheet “Chip resistors packing”.

FUNCTIONAL DESCRIPTION

OPERATING TEMPERATURE RANGE

YC102/104, TC122/124 Range:

-55°C to +125°C (Fig.13)

YC122/124/162/164/248/324/158T/358L/358T, TC164

Range:

-55°C to +155°C(Fig.14)

POWER RATING

Each type rated power at 70°C

YC102/104 = 1/32 W

YC122/124/162/164/248/158T/358L/358T = 1/16 W

YC324 = 1/8 W

TC122/124/164 = 1/16 W

RATED VOLTAGE

The DC or AC (rms) continuous working voltage corresponding to the rated power is determined by the following formula:

$$V = \sqrt{P \times R}$$

or max. working voltage whichever is less

Where

V=Continuous rated DC or AC (rms) working voltage (V)

P=Rated power (W)

R=Resistance value (Ω)

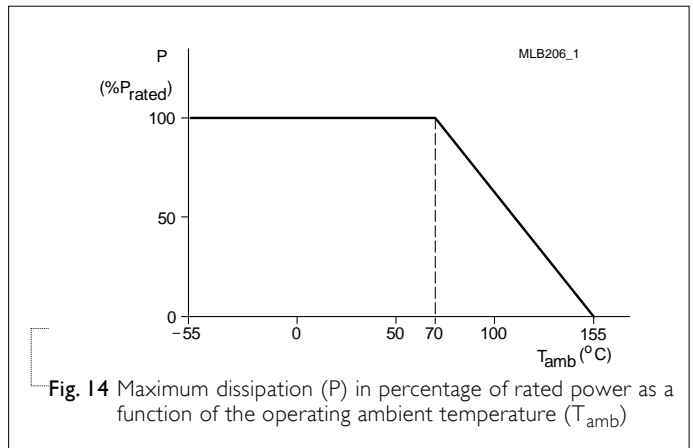
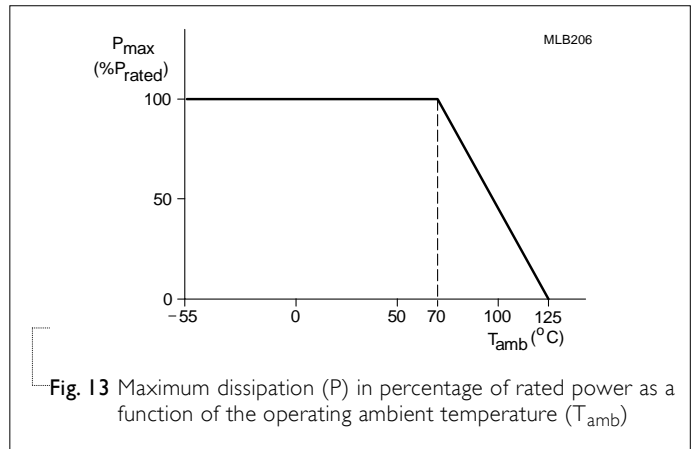

TESTS AND REQUIREMENTS

Table 4 Test condition, procedure and requirements

TEST	TEST METHOD	PROCEDURE	REQUIREMENTS
Life/ Operational Life/ Endurance	MIL-STD-202-method 108 IEC 60115-1 7.1	1,000 hours at 70±5 °C applied RCWV 1.5 hours on, 0.5 hour off, still air required	±(2%+0.05 Ω) <100 mΩ for Jumper
High Temperature Exposure/ Endurance at Upper Category Temperature	MIL-STD-202-method 108	1,000 hours at maximum operating temperature depending on specification, unpowered	±(1%+0.05 Ω) <50 mΩ for Jumper
Moisture Resistance	MIL-STD-202-method 106 IEC 60115-1 4.24.2	Each temperature / humidity cycle is defined at 8 hours, 3 cycles / 24 hours for 10d with 25 °C / 65 °C 95% R.H, without steps 7a & 7b, unpowered Parts mounted on test-boards, without condensation on parts Measurement at 24±2 hours after test conclusion	±(2%+0.05 Ω) <100 mΩ for Jumper
Thermal Shock	MIL-STD-202-method 107	-55/+125 °C Note: Number of cycles required is 300. Devices mounted Maximum transfer time is 20 seconds. Dwell time is 15 minutes. Air – Air	±(1%+0.05 Ω) <50 mΩ for Jumper
Short Time Overload	IEC60115-1 8.1	2.5 times RCWV or maximum overload voltage whichever is less for 5 sec at room temperature	±(2%+0.05 Ω) <50 mΩ for Jumper No visible damage
Board Flex/ Bending	IEC60115-1 9.8	Device mounted on PCB test board as described, only 1 board bending required 3 mm bending Bending time: 60±5 seconds Ohmic value checked during bending	±(1%+0.05 Ω) <50 mΩ for Jumper No visible damage

TEST	TEST METHOD	PROCEDURE	REQUIREMENTS
Solderability - Wetting	J-STD-002 test	Electrical Test not required Magnification 50X SMD conditions: 1 st step: aging 4 hours at 155 °C dry heat 2 nd step: method B1, leadfree solder bath at 245±3 °C Dipping time: 3±0.5 seconds	Well tinned (≥95% covered) No visible damage
- Leaching	J-STD-002 test	Leadfree solder, 260 °C, 30 seconds immersion time	No visible damage
- Resistance to Soldering Heat	MIL-STD-202-method 210	Condition B, no pre-heat of samples Leadfree solder, 260 °C, 10 seconds immersion time Procedure 2 for SMD: devices fluxed and cleaned with isopropanol	±(1%+0.05 Ω) <50 mΩ for Jumper No visible damage
Biased Humidity	AEC-Q200 Test 7 MIL-STD-202-Method 103	1,000 hours; 85 °C / 85% RH 10% of operating power Measurement at 24± 4 hours after test conclusion.	± (5.0%+0.05 Ω)

REVISION HISTORY

REVISION	DATE	CHANGE NOTIFICATION	DESCRIPTION
Version 9	Feb.19, 2019	-	- Update H dimension for YC124
Version 8	Dec. 24, 2018	-	- Update AEC-Q200 qualified
Version 7	Aug. 22, 2017	-	- Correct the typo for YC158T/358L/358T, Marking, "240" is 24ohm
Version 6	Jun. 1, 2017	-	- Update ordering information for networks YC158T/YC358L/YC358T
Version 5	Feb. 14, 2017	-	- Update YC158 and 358 part number to YC158T , YC358L and YC358T
Version 4	Dec. 22, 2016	-	- Delete YC102 default code L type
Version 3	Apr. 29, 2016	-	- Update YC series and TC164 dimension
Version 2	Dec. 11, 2015	-	- Update Operating Temperature
Version 1	Feb. 04, 2015	-	- Update YC102 to flat type
Version 0	Nov. 14, 2014	-	- First issue of this specification

LEGAL DISCLAIMER

YAGEO, its distributors and agents (collectively, "YAGEO"), hereby disclaims any and all liabilities for any errors, inaccuracies or incompleteness contained in any product related information, including but not limited to product specifications, datasheets, pictures and/or graphics. YAGEO may make changes, modifications and/or improvements to product related information at any time and without notice.

YAGEO makes no representation, warranty, and/or guarantee about the fitness of its products for any particular purpose or the continuing production of any of its products. To the maximum extent permitted by law, YAGEO disclaims (i) any and all liability arising out of the application or use of any YAGEO product, (ii) any and all liability, including without limitation special, consequential or incidental damages, and (iii) any and all implied warranties, including warranties of fitness for a particular purpose, non-infringement and merchantability.

YAGEO products are designed for general purpose applications under normal operation and usage conditions. Please contact YAGEO for the applications listed below which require especially high reliability for the prevention of defects which might directly cause damage to the third party's life, body or property: Aerospace equipment (artificial satellite, rocket, etc.), Atomic energy-related equipment, Aviation equipment, Disaster prevention equipment, crime prevention equipment, Electric heating apparatus, burning equipment, Highly public information network equipment, data-processing equipment, Medical devices, Military equipment, Power generation control equipment, Safety equipment, Traffic signal equipment, Transportation equipment and Undersea equipment, or for any other application or use in which the failure of YAGEO products could result in personal injury or death, or serious property damage. Particularly **YAGEO Corporation and its affiliates do not recommend the use of commercial or automotive grade products for high reliability applications or manned space flight.**

Information provided here is intended to indicate product specifications only. YAGEO reserves all the rights for revising this content without further notification, as long as products are unchanged. Any product change will be announced by PCN.

Mouser Electronics

Authorized Distributor

Click to View Pricing, Inventory, Delivery & Lifecycle Information:

[Pulse:](#)

[TC1000](#) [TC10000](#) [TC10000P](#) [TC1000P](#) [TC5000](#) [TC5000P](#)

[YAGEO:](#)

[YC164-JR-074K7L](#) [YC164-JR-078K2L](#) [YC164-JR-072K2L](#) [YC164-JR-0756RL](#) [YC248-JR-0710KL](#) [TC164-JR-0733RL](#) [YC124-JR-0733RL](#) [YC164-JR-070RL](#) [YC164-JR-07100RL](#) [YC164-JR-0710KL](#) [YC164-JR-0710RL](#) [YC164-JR-07150RL](#) [YC164-JR-0747RL](#) [YC164-JR-0751RL](#) [YC164-JR-0775RL](#) [YC164-JR-072K7L](#) [YC248-JR-074K7L](#) [TC164-JR-07100RL](#) [TC164-JR-0710KL](#) [YC164-JR-072KL](#) [YC164-JR-07220KL](#) [YC122-JR-0715RL](#) [YC124-JR-0724RL](#) [YC164-JR-075K6L](#) [YC164-JR-071ML](#) [YC164-JR-07220RL](#) [YC164-FR-07100RL](#) [TC164-JR-0747RL](#) [YC164-JR-07180RL](#) [TC164-JR-0722KL](#) [YC122-JR-0710RL](#) [YC124-JR-0727RL](#) [YC164-JR-07160RL](#) [YC124-JR-07330RL](#) [YC122-JR-0722RL](#) [YC164-JR-0747KL](#) [TC164-JR-0710RL](#) [TC164-JR-07220RL](#) [TC164-JR-0722RL](#) [YC124-JR-0710KL](#) [YC164-JR-0722KL](#) [TC164-JR-07100KL](#) [TC164-JR-070RL](#) [YC124-JR-07150RL](#) [YC124-FR-0733RL](#) [YC122-JR-0736RL](#) [YC164-JR-07120RL](#) [YC164-JR-0715KL](#) [YC164-JR-0722RL](#) [YC124-JR-0768RL](#) [YC164-JR-07240RL](#) [YC164-JR-0751KL](#) [YC124-JR-071KL](#) [YC124-JR-0747KL](#) [YC124-JR-074K7L](#) [YC124-JR-0710RL](#) [TC164-JR-071KL](#) [YC164-JR-0727RL](#) [YC164-JR-07200RL](#) [YC164-JR-07300RL](#) [YC164-JR-07470RL](#) [YC124-JR-073K3L](#) [TC164-JR-0747KL](#) [YC164-JR-075K1L](#) [YC124-FR-0749R9L](#) [YC164-JR-07390RL](#) [YC124-JR-0751RL](#) [YC124-JR-07100KL](#) [YC124-JR-07100RL](#) [YC124-JR-0747RL](#) [YC164-JR-0720KL](#) [YC124-JR-0756RL](#) [YC164-JR-07510RL](#) [TC164-JR-07270RL](#) [YC124-JR-0715RL](#) [YC124-JR-070RL](#) [TC164-JR-073K3L](#) [YC124-JR-0736RL](#) [YC164-JR-0739RL](#) [TC164-JR-07330RL](#) [YC164-JR-071K8L](#) [YC164-JR-07130RL](#) [TC164-JR-07470RL](#) [TC164-JR-072K7L](#) [YC164-JR-07680RL](#) [YC164-JR-071K2L](#) [YC124-JR-0739RL](#) [YC164-JR-07330RL](#) [YC164-JR-07560RL](#) [TC164-JR-07120RL](#) [YC124-JR-0775RL](#) [YC164-JR-0724RL](#) [YC164-JR-071K5L](#) [TC164-JR-072K2L](#) [YC164-JR-07100KL](#) [YC124-JR-0782RL](#) [YC124-JR-0730RL](#) [TC164-JR-074K7L](#) [TC164-JR-0751RL](#) [YC158TJR-0762RL](#)