

High Voltage Power Transistors

DPAK for Surface Mount Applications

MJD340 (NPN), MJD350 (PNP)

Designed for line operated audio output amplifier, switchmode power supply drivers and other switching applications.

Features

- Lead Formed for Surface Mount Applications in Plastic Sleeves (No Suffix)
- Electrically Similar to Popular MJE340 and MJE350
- Epoxy Meets UL 94 V-0 @ 0.125 in
- NJV Prefix for Automotive and Other Applications Requiring Unique Site and Control Change Requirements; AEC-Q101 Qualified and PPAP Capable
- These Devices are Pb-Free, Halogen Free/BFR Free and are RoHS Compliant

MAXIMUM RATINGS

Rating	Symbol	Max	Unit
Collector-Emitter Voltage	V_{CEO}	300	Vdc
Collector-Base Voltage	V_{CB}	300	Vdc
Emitter-Base Voltage	V_{EB}	3	Vdc
Collector Current - Continuous	I_C	0.5	Adc
Collector Current - Peak	I_{CM}	0.75	Adc
Total Power Dissipation @ $T_C = 25^\circ\text{C}$ Derate above 25°C	P_D	15 0.12	W W/ $^\circ\text{C}$
Total Power Dissipation (Note 1) @ $T_A = 25^\circ\text{C}$ Derate above 25°C	P_D	1.56 0.012	W W/ $^\circ\text{C}$
Operating and Storage Junction Temperature Range	T_J, T_{stg}	-65 to +150	$^\circ\text{C}$
ESD - Human Body Model MJD340 (NPN) MJD350 (PNP)	HBM	3B 2	V
ESD - Machine Model MJD340 (NPN) MJD350 (PNP)	MM	M4 M4	V

Stresses exceeding those listed in the Maximum Ratings table may damage the device. If any of these limits are exceeded, device functionality should not be assumed, damage may occur and reliability may be affected.

1. These ratings are applicable when surface mounted on the minimum pad sizes recommended.

SILICON POWER TRANSISTORS 0.5 AMPERE 300 VOLTS, 15 WATTS

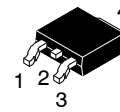
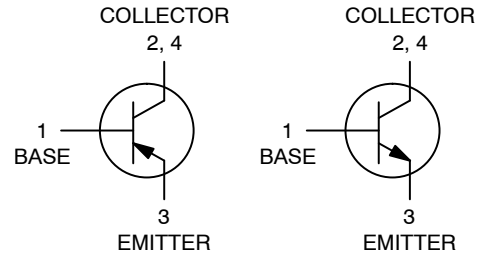

DPAK
CASE 369C
STYLE 1

MARKING DIAGRAM

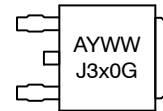

- A = Assembly Location
- Y = Year
- WW = Work Week
- J3x0 = Device Code
x= 4 or 5
- G = Pb-Free Package

ORDERING INFORMATION

See detailed ordering and shipping information in the package dimensions section on page 5 of this data sheet.

MJD340 (NPN), MJD350 (PNP)

THERMAL CHARACTERISTICS

Characteristic	Symbol	Max	Unit
Thermal Resistance, Junction-to-Case	$R_{\theta JC}$	8.33	$^{\circ}C/W$
Thermal Resistance, Junction-to-Ambient (Note 2)	$R_{\theta JA}$	80	$^{\circ}C/W$
Leading Temperature for Soldering Purpose	T_L	260	$^{\circ}C$

2. These ratings are applicable when surface mounted on the minimum pad sizes recommended.

ELECTRICAL CHARACTERISTICS ($T_C = 25^{\circ}C$ unless otherwise noted)

Characteristic	Symbol	Min	Max	Unit
----------------	--------	-----	-----	------

OFF CHARACTERISTICS

Collector-Emitter Sustaining Voltage (Note 3) ($I_C = 1\text{ mA}$, $I_B = 0$)	$V_{CEO(sus)}$	300	-	V
Collector Cutoff Current ($V_{CB} = 300\text{ V}$, $I_E = 0$)	I_{CEO}	-	0.1	mA
Emitter Cutoff Current ($V_{BE} = 3\text{ V}$, $I_C = 0$)	I_{EBO}	-	0.1	mA

ON CHARACTERISTICS (Note 3)

DC Current Gain ($I_C = 50\text{ mA}$, $V_{CE} = 10\text{ V}$)	h_{FE}	30	240	-
Collector-Emitter Saturation Voltage ($I_C = 100\text{ mA}$, $I_B = 10\text{ mA}$)	$V_{CE(sat)}$	-	1	V
Base-Emitter On Voltage ($I_C = 1\text{ A}$, $V_{CE} = 10\text{ V}$)	$V_{BE(on)}$	-	1.5	V

DYNAMIC CHARACTERISTICS

Current Gain – Bandwidth Product ($I_C = 50\text{ mA}$, $V_{CE} = 10\text{ V}$, $f = 10\text{ MHz}$)	f_T	10	-	MHz
---	-------	----	---	-----

Product parametric performance is indicated in the Electrical Characteristics for the listed test conditions, unless otherwise noted. Product performance may not be indicated by the Electrical Characteristics if operated under different conditions.

3. Pulse Test: Pulse Width $\leq 300\ \mu s$, Duty Cycle $\leq 2\%$.

MJD340 (NPN), MJD350 (PNP)

TYPICAL CHARACTERISTICS

MJD340

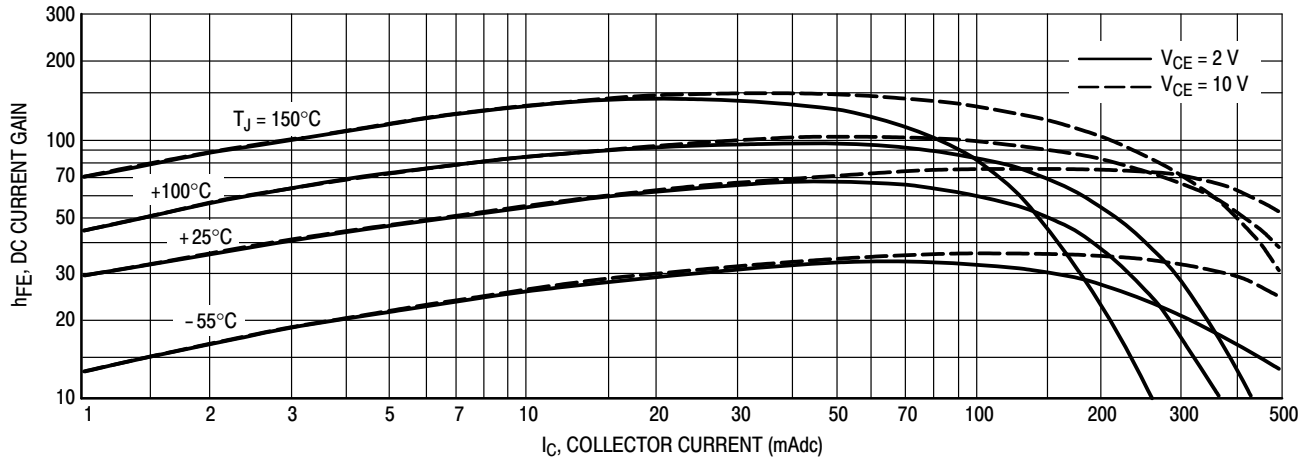

Figure 1. DC Current Gain

MJD340

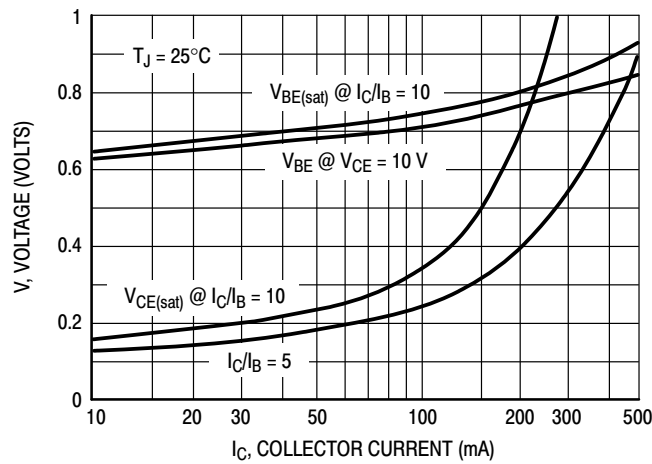

Figure 2. "On" Voltages

MJD350

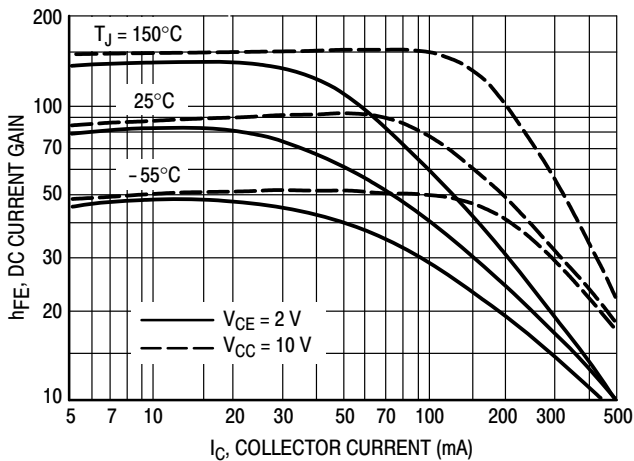

Figure 3. DC Current Gain

MJD350

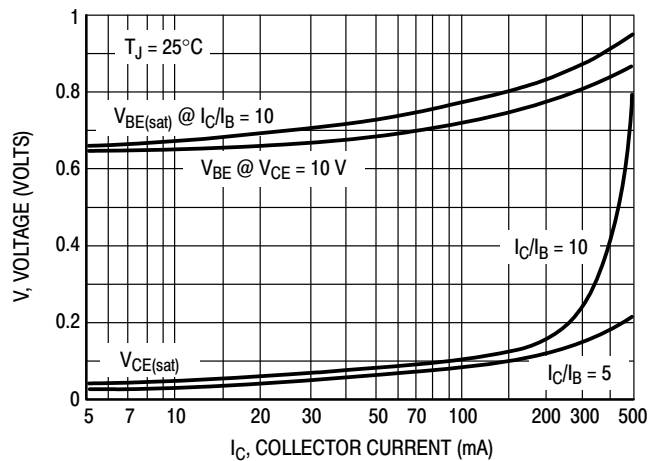

Figure 4. "On" Voltages

MJD340 (NPN), MJD350 (PNP)

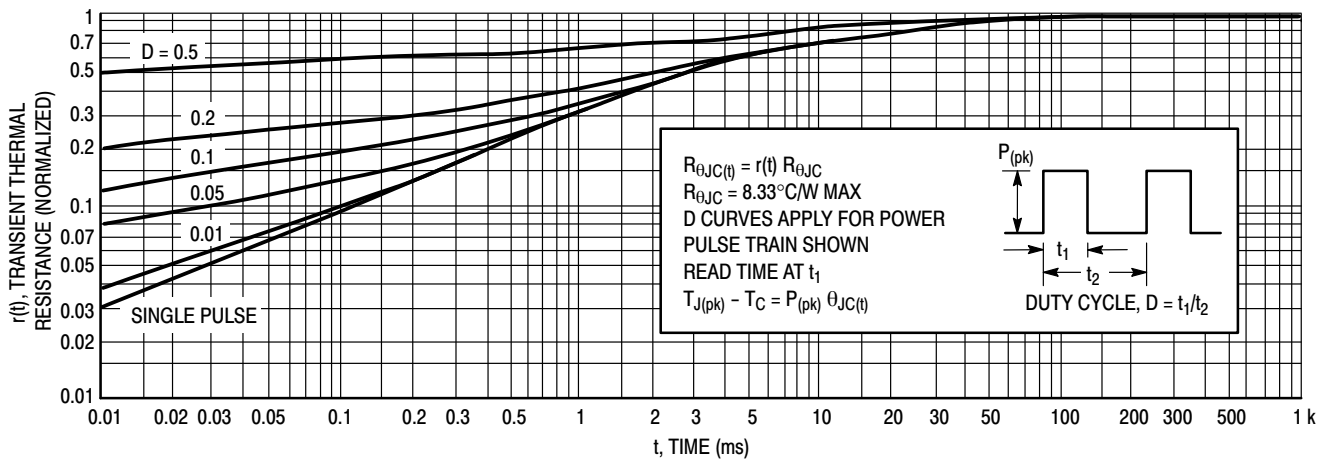

Figure 5. Thermal Response

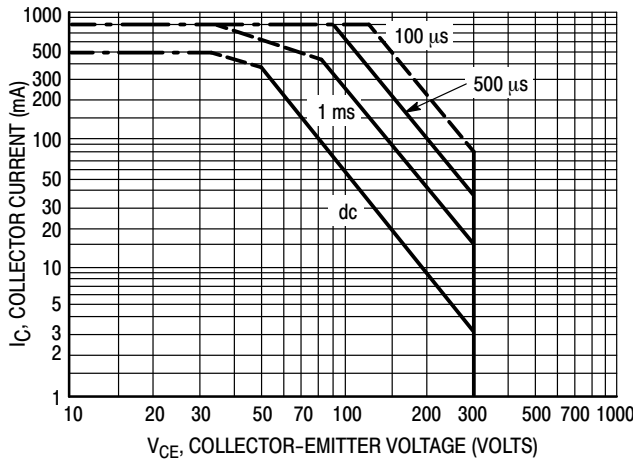

Figure 6. Active Region Safe Operating Area

There are two limitations on the power handling ability of a transistor: average junction temperature and second breakdown. Safe operating area curves indicate $I_C - V_{CE}$ limits of the transistor that must be observed for reliable operation; i.e., the transistor must not be subjected to greater dissipation than the curves indicate.

The data of Figure 6 is based on $T_{J(pk)} = 150^{\circ}\text{C}$; T_C is variable depending on conditions. Second breakdown pulse limits are valid for duty cycles to 10% provided $T_{J(pk)} \leq 150^{\circ}\text{C}$. $T_{J(pk)}$ may be calculated from the data in Figure 5. At high case temperatures, thermal limitations will reduce the power that can be handled to values less than the limitations imposed by second breakdown.

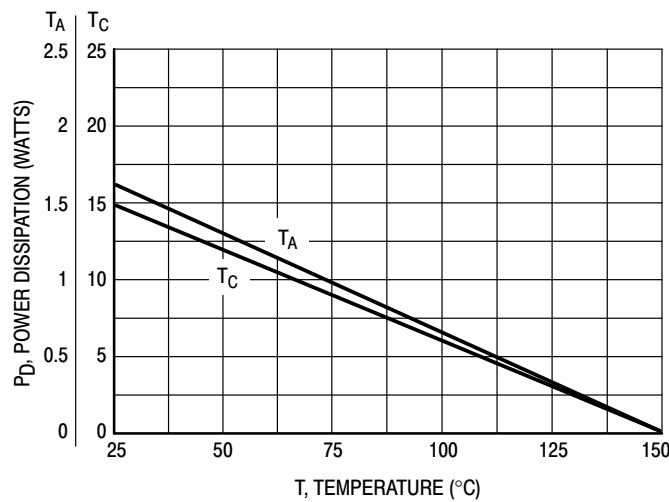

Figure 7. Power Derating

MJD340 (NPN), MJD350 (PNP)

ORDERING INFORMATION

Device	Package	Shipping†
MJD340G	DPAK (Pb-Free)	75 Units / Rail
MJD340RLG	DPAK (Pb-Free)	1,800 / Tape & Reel
MJD340T4G	DPAK (Pb-Free)	2,500 / Tape & Reel
MJD340T4GN	DPAK (Pb-Free)	2,500 / Tape & Reel
NJVMJD340T4G	DPAK (Pb-Free)	2,500 / Tape & Reel
MJD350G	DPAK (Pb-Free)	75 Units / Rail
MJD350T4G	DPAK (Pb-Free)	2,500 / Tape & Reel
MJD350T4GN	DPAK (Pb-Free)	2,500 / Tape & Reel
NJVMJD350T4G	DPAK (Pb-Free)	2,500 / Tape & Reel

†For information on tape and reel specifications, including part orientation and tape sizes, please refer to our Tape and Reel Packaging Specifications Brochure, BRD8011/D.

onsemi, **Onsemi**, and other names, marks, and brands are registered and/or common law trademarks of Semiconductor Components Industries, LLC dba "**onsemi**" or its affiliates and/or subsidiaries in the United States and/or other countries. **onsemi** owns the rights to a number of patents, trademarks, copyrights, trade secrets, and other intellectual property. A listing of **onsemi**'s product/patent coverage may be accessed at www.onsemi.com/site/pdf/Patent-Marking.pdf. **onsemi** reserves the right to make changes at any time to any products or information herein, without notice. The information herein is provided "as-is" and **onsemi** makes no warranty, representation or guarantee regarding the accuracy of the information, product features, availability, functionality, or suitability of its products for any particular purpose, nor does **onsemi** assume any liability arising out of the application or use of any product or circuit, and specifically disclaims any and all liability, including without limitation special, consequential or incidental damages. Buyer is responsible for its products and applications using **onsemi** products, including compliance with all laws, regulations and safety requirements or standards, regardless of any support or applications information provided by **onsemi**. "Typical" parameters which may be provided in **onsemi** data sheets and/or specifications can and do vary in different applications and actual performance may vary over time. All operating parameters, including "Typicals" must be validated for each customer application by customer's technical experts. **onsemi** does not convey any license under any of its intellectual property rights nor the rights of others. **onsemi** products are not designed, intended, or authorized for use as a critical component in life support systems or any FDA Class 3 medical devices or medical devices with a same or similar classification in a foreign jurisdiction or any devices intended for implantation in the human body. Should Buyer purchase or use **onsemi** products for any such unintended or unauthorized application, Buyer shall indemnify and hold **onsemi** and its officers, employees, subsidiaries, affiliates, and distributors harmless against all claims, costs, damages, and expenses, and reasonable attorney fees arising out of, directly or indirectly, any claim of personal injury or death associated with such unintended or unauthorized use, even if such claim alleges that **onsemi** was negligent regarding the design or manufacture of the part. **onsemi** is an Equal Opportunity/Affirmative Action Employer. This literature is subject to all applicable copyright laws and is not for resale in any manner.

ADDITIONAL INFORMATION

TECHNICAL PUBLICATIONS:

Technical Library: www.onsemi.com/design/resources/technical-documentation
onsemi Website: www.onsemi.com

ONLINE SUPPORT: www.onsemi.com/support

For additional information, please contact your local Sales Representative at www.onsemi.com/support/sales

Mouser Electronics

Authorized Distributor

Click to View Pricing, Inventory, Delivery & Lifecycle Information:

[onsemi:](#)

[MJD340](#) [MJD340G](#) [MJD340RL](#) [MJD340RLG](#) [MJD340T4](#) [MJD340T4G](#) [MJD350](#) [MJD350G](#) [MJD350T4](#)
[MJD350T4G](#) [MJD340TF](#) [NJVMJD340T4G](#) [NJVMJD350T4G](#) [MJD350T4GN](#) [MJD340T4GN](#)