

# General Specifications

## Electrical Capacity (Resistive Load)

**Power Level:** 6A @ 125V AC or 3A @ 250V AC

## Other Ratings

**Contact Resistance:** 10 milliohms maximum

**Insulation Resistance:** 1,000 megohms minimum @ 500V DC

**Dielectric Strength:** 1,000V AC minimum between contacts for 1 minute minimum;  
1,500V AC minimum between contacts & case for 1 minute minimum

**Mechanical Life:** 50,000 operations minimum

**Electrical Life:** 25,000 operations minimum

**Contact Timing:** Nonshorting (break-before-make)

**Total Travel:** .087" (2.2mm)

## Materials & Finishes

**Actuator:** Polyamide (UL94V-0)

**Frame:** Stainless steel

**Case:** Glass fiber reinforced diallyl phthalate resin (UL94V-0)

**Movable Contacts:** Silver alloy

**Stationary Contacts:** Silver capped copper with silver plating

**Terminals:** Copper or brass with silver plating

## Environmental Data

**Operating Temp Range:** -15°C through +60°C (+5°F through +140°F)

**Humidity:** 90 ~ 95% humidity for 96 hours @ 40°C (104°F)

**Vibration:** 10 ~ 55Hz with peak-to-peak amplitude of 1.5mm traversing the frequency range  
& returning in 1 minute; 3 right angled directions for 2 hours

**Shock:** 50G (490m/s<sup>2</sup>) acceleration (tested in 6 right angled directions, with 5 shocks in each direction)

## Processing

**Soldering Time & Temp:** Wave Soldering Recommended (PC version): See Profile A in Supplement section.

Manual Soldering: See Profile A in Supplement section.

Note: Lever must be in center position while soldering.

**Cleaning:** These devices are not process sealed. Hand clean locally using alcohol based solution.

## Standards & Certifications

**Flammability Standards:** UL94V-0 rated actuator & case

# Distinctive Characteristics

Bright, LED illumination at top of actuator.

Over-center actuator block and plunger design gives crisp actuation, diminishes sparking, and increases operating life.

Guide interlocked with actuator block prevents window locking and maintains correct plunger alignment to assure contact stability.

Antijamming design protects contacts from damage due to excessive downward force on the actuator.

High internal barriers between poles and insulating sheet between case and actuator block give added protection to contacts.

Prominent external insulating barriers increase insulation resistance and dielectric strength.

Epoxy sealed terminals prevent entry of flux, solvents, and other contaminants.

Clinching of frame to case well above base and terminals provides 1,500V dielectric strength.

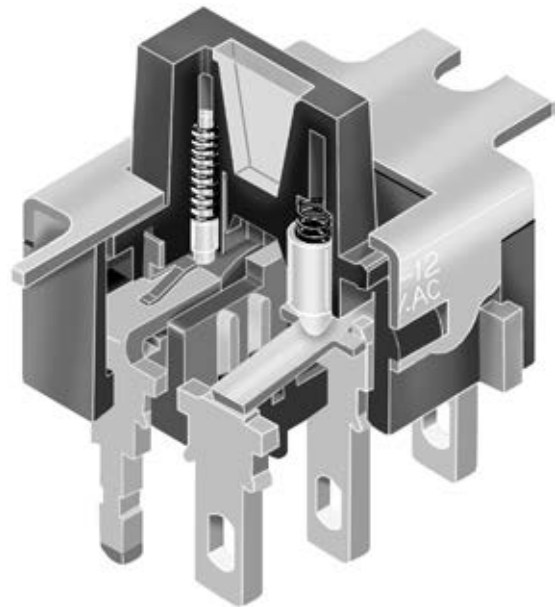

Actual Size

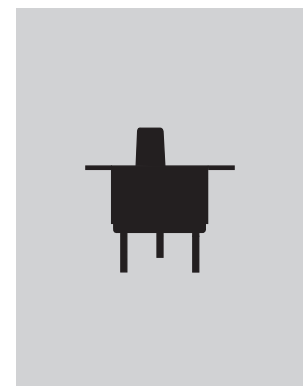

Toggles

Rockers

Pushbuttons

Illuminated PB

Programmable

Keylocks

Rotaries

**H** Slides

Tactiles

Tilt

Touch

Indicators

Accessories

Supplement

### TYPICAL SWITCH ORDERING EXAMPLE

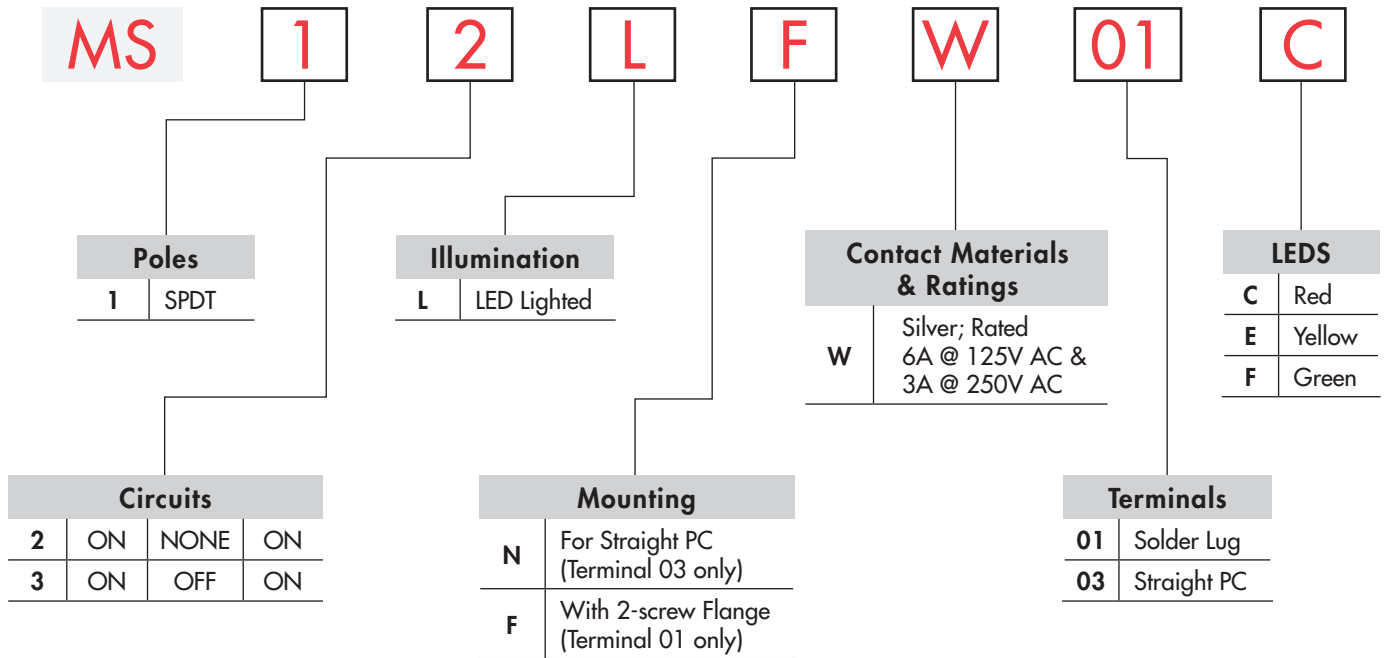

### DESCRIPTION FOR TYPICAL ORDERING EXAMPLE

**MS12LFW01C**

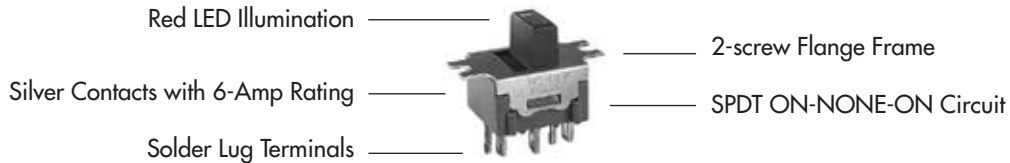

### POLES & CIRCUITS

Pole	Model	Slide Position			Connected Terminals			Throw & Schematics
		Left	Center	Right	Left	Center	Right	
SP	MS12	ON	NONE	ON	2-1	OPEN	2-3	Note: Terminal numbers are not actually on the switch. LED circuit is isolated and requires an external connection.
	MS13	ON	OFF	ON				

### CONTACT MATERIALS & RATINGS



Silver over Silver

Power Level

6A @ 125V AC & 3A @ 250V AC

## MOUNTING TYPES & TERMINALS

**N** Straight PC Mount  
(Combines with  
Straight PC Terminal  
03 only)



**03** Straight PC

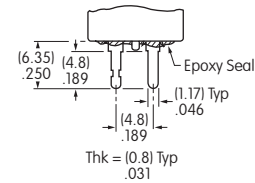

**F** 2-screw Flange  
(Combines with Solder  
Lug Terminal 01 only)



**01** Solder Lug

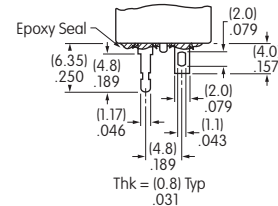

## LED COLORS & SPECIFICATIONS

LEDs are supplied as an integral part of the switch (not available separately). The lamp circuit is independent of switch operation. Electrical specifications shown are determined at a basic temperature of 25°C. If the source voltage exceeds the rated voltage, a ballast resistor is required. The resistor value can be calculated by using the formula given in the Supplement.

		<b>C</b> Red	<b>E</b> Yellow	<b>F</b> Green
Maximum Forward Current	$I_{FM}$	30mA	30mA	30mA
Typical Forward Current	$I_F$	16mA	16mA	16mA
Forward Voltage	$V_F$	1.98V	2.05V	1.95V
Maximum Reverse Voltage	$V_{RM}$	5V	5V	5V
Current Reduction Rate Above 25°C	$\Delta I_F$	0.40mA/°C	0.40mA/°C	0.40mA/°C
Ambient Temperature Range		-15° ~ +60°C		

## TYPICAL SWITCH DIMENSIONS

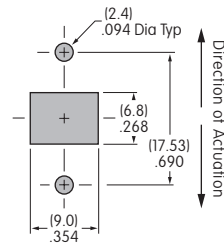
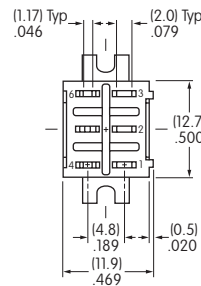
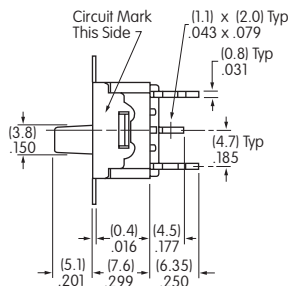
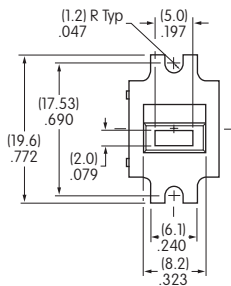

Solder Lug Terminals



Actuator in LEFT Position

Maximum Panel Thickness .197" (5.0mm)

**MS12LFW01C**

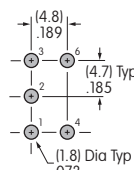
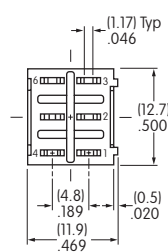
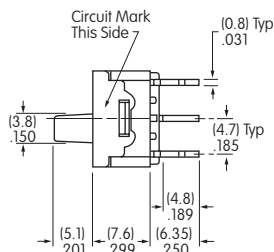
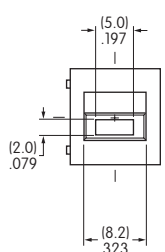

Straight PC Terminals



Actuator in LEFT Position

Maximum Panel Thickness .197" (5.0mm)

**MS12LNW03C**