

# MOSFET – P-Channel, POWERTRENCH®

**-100 V, -50 A, 22 mΩ**

## FDMS86163P

### General Description

This P-Channel MOSFET is produced using onsemi's advanced POWERTRENCH process that has been especially tailored to minimize the on-state resistance and yet maintain superior switching performance.

### Features

- Max  $r_{DS(on)}$  = 22 mΩ at  $V_{GS} = -10$  V,  $I_D = -7.9$  A
- Max  $r_{DS(on)}$  = 30 mΩ at  $V_{GS} = -6$  V,  $I_D = -5.9$  A
- Very Low RDS-on Mid Voltage P-Channel Silicon Technology Optimised for Low Qg
- This Product is Optimised for Fast Switching Applications As Well As Load Switch Applications
- 100% UIL Tested
- This Device is Pb-Free, Halogen Free/BFR Free and is RoHS Compliant

### Applications

- Active Clamp Switch
- Load Switch

### MOSFET MAXIMUM RATINGS ( $T_A = 25^\circ\text{C}$ unless otherwise noted)

Parameter	Parameter	Symbol	Value	Unit
Drain-to-Source Voltage		$V_{DS}$	-100	V
Gate-to-Source Voltage		$V_{GS}$	±25	V
Drain Current –Continuous	$T_C = 25^\circ\text{C}$	$I_D$	-50	A
	$T_A = 25^\circ\text{C}$ (Note 1a)		-7.9	
	Pulsed (Note 4)		-100	
Single Pulse Avalanche Energy (Note 3)		$E_{AS}$	486	mJ
Power Dissipation	$T_C = 25^\circ\text{C}$	$P_D$	104	W
	$T_A = 25^\circ\text{C}$ (Note1a)		2.5	
Operating and Storage Junction Temperature Range		$T_J, T_{STG}$	-55 to +150	$^\circ\text{C}$

Stresses exceeding those listed in the Maximum Ratings table may damage the device. If any of these limits are exceeded, device functionality should not be assumed, damage may occur and reliability may be affected.

$BV_{DSS}$	$R_{DS(on)}$ MAX	$I_D$ MAX
-100 V	22 mΩ @ -10 V	-50 A

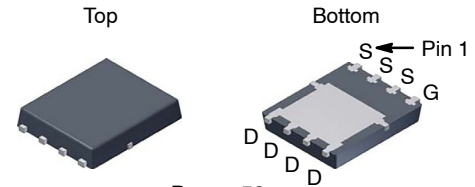

Power 56  
PQFN8  
CASE 483AE

### MARKING DIAGRAM

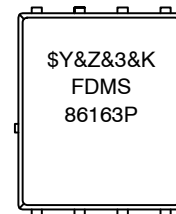

- \$Y = onsemi Logo
- &Z = Assembly Location
- &3 = 3-Digit Date Code
- &K = Lot Code
- FDMS86163P = Specific Device Code

### PIN CONNECTION

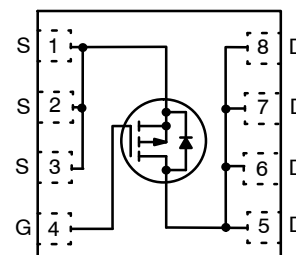

### ORDERING INFORMATION

Device	Package	Shipping†
FDMS86163P	PQFN-8 (Pb-Free)	3000 / Tape & Reel

†For information on tape and reel specifications, including part orientation and tape sizes, please refer to our Tape and Reel Packaging Specification Brochure, BRD8011/D.

# FDMS86163P

## THERMAL CHARACTERISTICS

Symbol	Parameter	Value	Unit
$R_{\theta JC}$	Thermal Resistance, Junction to Case	1.2	°C/W
$R_{\theta JA}$	Thermal Resistance Junction to Ambient (Note 1a)	50	

## ELECTRICAL CHARACTERISTICS ( $T_J = 25^\circ\text{C}$ unless otherwise specified)

Symbol	Parameter	Conditions	Min	Typ	Max	Unit
--------	-----------	------------	-----	-----	-----	------

### OFF CHARACTERISTICS

$B_{VDSS}$	Drain to Source Breakdown Voltage	$I_D = -250 \mu\text{A}, V_{GS} = 0 \text{ V}$	-100	-	-	V
$\Delta B_{VDSS}/\Delta T_J$	Breakdown Voltage Temperature Coefficient	$I_D = -250 \mu\text{A}$ , Referenced to $25^\circ\text{C}$	-	-59	-	mV/°C
$I_{DSS}$	Zero Gate Voltage Drain Current	$V_{DS} = -80 \text{ V}, V_{GS} = 0 \text{ V}$	-	-	-1	$\mu\text{A}$
$I_{GSS}$	Gate to Source Leakage Current	$V_{GS} = \pm 25 \text{ V}, V_{DS} = 0 \text{ V}$	-	-	$\pm 100$	nA

### ON CHARACTERISTICS

$V_{GS(th)}$	Gate to Source Threshold Voltage	$V_{GS} = V_{DS}, I_D = -250 \mu\text{A}$	-2	-2.8	-4	V
$\Delta V_{GS(th)}/\Delta T_J$	Gate to Source Threshold Voltage Temperature Coefficient	$I_D = -250 \mu\text{A}$ , Referenced to $25^\circ\text{C}$	-	6.2	-	mV/°C
$r_{DS(on)}$	Static Drain to Source On Resistance	$V_{GS} = -10 \text{ V}, I_D = -7.9 \text{ A}$	-	17.8	22	m $\Omega$
		$V_{GS} = -6 \text{ V}, I_D = -5.9 \text{ A}$	-	21.3	30	
		$V_{GS} = -10 \text{ V}, I_D = -7.9 \text{ A}, T_J = 125^\circ\text{C}$	-	29	36	
$g_{FS}$	Forward Transconductance	$V_{DS} = -10 \text{ V}, I_D = -7.9 \text{ A}$	-	29	-	S

### DYNAMIC CHARACTERISTICS

$C_{iss}$	Input Capacitance	$V_{DS} = -50 \text{ V}, V_{GS} = 0 \text{ V}, f = 1 \text{ MHz}$	-	3070	4085	pF
$C_{oss}$	Output Capacitance		-	501	670	
$C_{rss}$	Reverse Transfer Capacitance		-	21	35	
$R_g$	Gate Resistance		0.1	2.6	5.3	$\Omega$

### SWITCHING CHARACTERISTICS

$t_{d(on)}$	Turn-On Delay	$V_{DD} = -50 \text{ V}, I_D = -7.9 \text{ A}, V_{GS} = -10 \text{ V}, R_{GEN} = 6 \Omega$	-	17	30	ns	
$t_r$	Rise Time		-	8.8	18		
$t_{d(off)}$	Turn-Off Delay		-	33	53		
$t_f$	Fall Time		-	6.9	14		
$Q_g$	Total Gate Charge	$V_{GS} = 0 \text{ V to } -10 \text{ V}$	$V_{DD} = -50 \text{ V}, I_D = -7.9 \text{ A}$	-	42	59	nC
$Q_g$	Total Gate Charge	$V_{GS} = 0 \text{ V to } -6 \text{ V}$		-	26	37	
$Q_{gs}$	Gate to Source Gate Charge	$V_{DD} = -50 \text{ V}, I_D = -7.9 \text{ A}$	-	11.8	-		
$Q_{gd}$	Gate to Drain "Miller" Charge		-	7.1	-		

# FDMS86163P

## ELECTRICAL CHARACTERISTICS ( $T_J = 25^\circ\text{C}$ unless otherwise specified) (continued)

Symbol	Parameter	Conditions	Min	Typ	Max	Unit
<b>DRAIN-SOURCE DIODE CHARACTERISTICS</b>						
$V_{SD}$	Source to Drain Diode Forward Voltage	$V_{GS} = 0\text{ V}, I_S = -7.9\text{ A}$ (Note 2)	-	-0.81	-1.3	V
		$V_{GS} = 0\text{ V}, I_S = -2\text{ A}$ (Note 2)	-	-0.75	-1.2	
$t_{rr}$	Reverse Recovery Time	$I_F = -7.9\text{ A}, di/dt = 100\text{ A}/\mu\text{s}$	-	63	102	ns
$Q_{rr}$	Reverse Recovery Charge		-	132	210	nC

Product parametric performance is indicated in the Electrical Characteristics for the listed test conditions, unless otherwise noted. Product performance may not be indicated by the Electrical Characteristics if operated under different conditions.

- $R_{\theta JA}$  is determined with the device mounted on a 1 in<sup>2</sup> pad 2 oz copper pad on a 1.5 x 1.5 in. board of FR-4 material.  $R_{\theta JC}$  is guaranteed by design while  $R_{\theta CA}$  is determined by the user's board design.

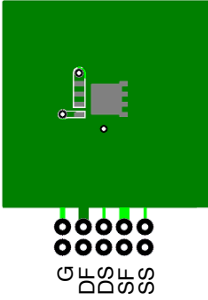

a)  $50^\circ\text{C}/\text{W}$  when mounted on a 1 in<sup>2</sup> pad of 2 oz copper

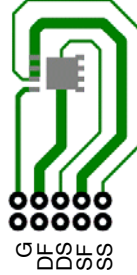

b)  $50^\circ\text{C}/\text{W}$  when mounted on a minimum pad of 2 oz copper

- Pulse Test: Pulse Width < 300  $\mu\text{s}$ , Duty cycle < 2.0%.
- Starting  $T_J = 25^\circ\text{C}$ ; P-ch:  $L = 3\text{ mH}$ ,  $I_{AS} = -18\text{ A}$ ,  $V_{DD} = -100\text{ V}$ ,  $V_{GS} = -10\text{ V}$ . 100% test at  $L = 0.1\text{ mH}$ ,  $I_{AS} = -58\text{ A}$ .
- Pulse  $I_d$  refers to Figure 11. Forward Bias Safe Operation Area.

TYPICAL CHARACTERISTICS ( $T_J = 25^\circ\text{C}$  unless otherwise noted)

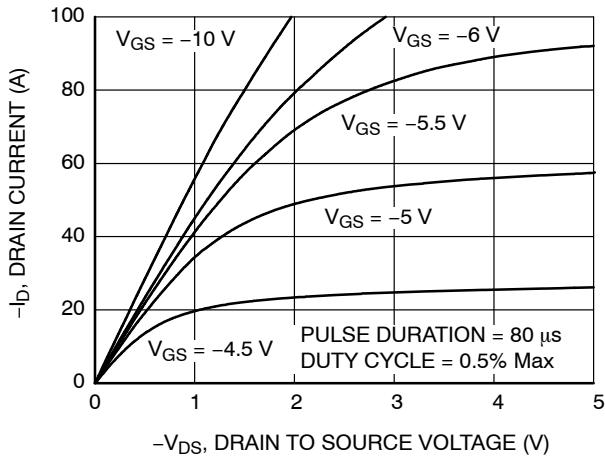

Figure 1. On Region Characteristics

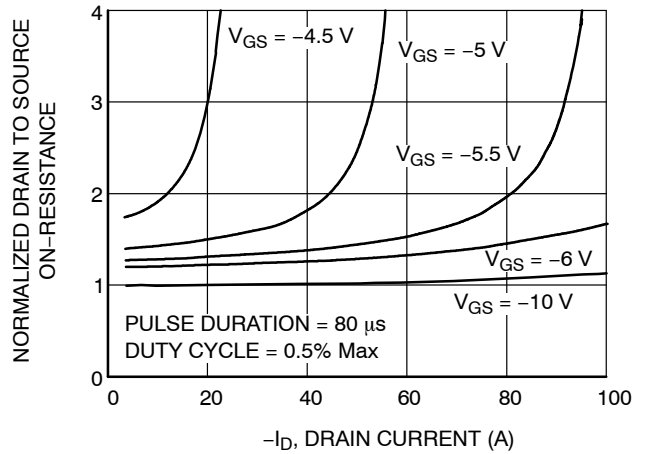

Figure 2. Normalized On-Resistance vs. Drain Current and Gate Voltage

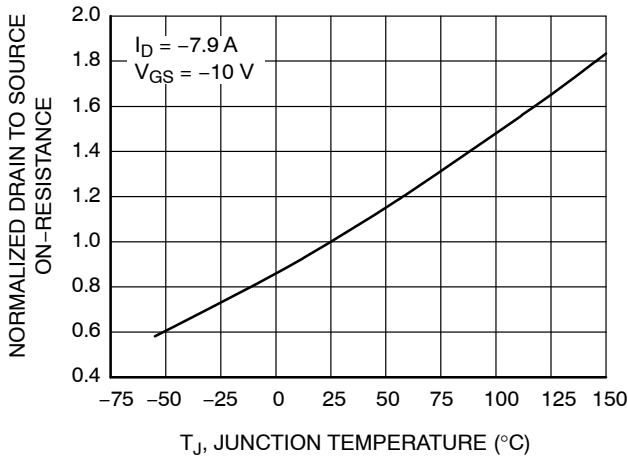

Figure 3. Normalized On Resistance vs. Junction Temperature

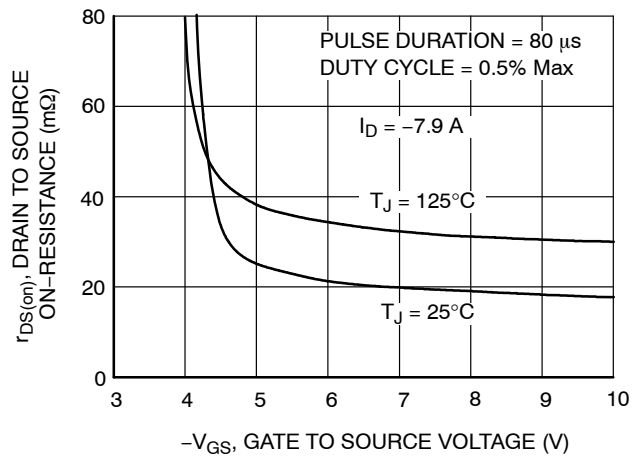

Figure 4. On-Resistance vs. Gate to Source Voltage

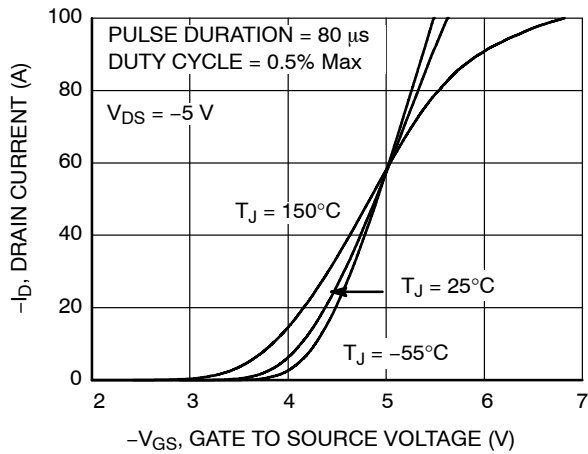

Figure 5. Transfer Characteristics

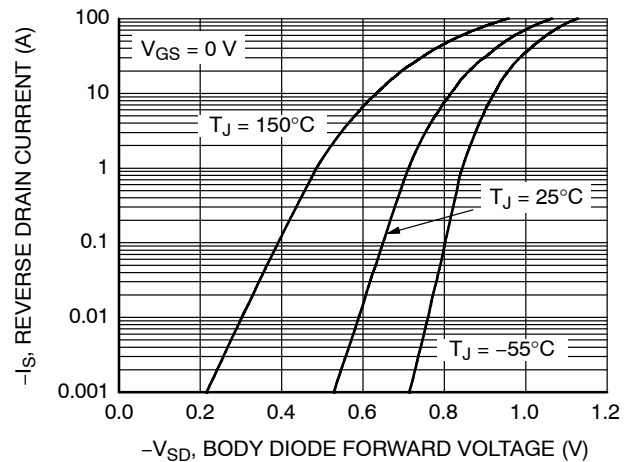

Figure 6. Source to Drain Diode Forward Voltage vs. Source Current

TYPICAL CHARACTERISTICS ( $T_J = 25^\circ\text{C}$  unless otherwise noted) (continued)

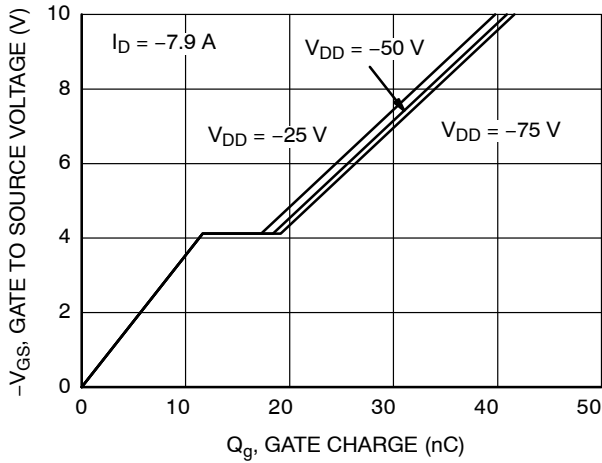

Figure 7. Gate Charge Characteristics

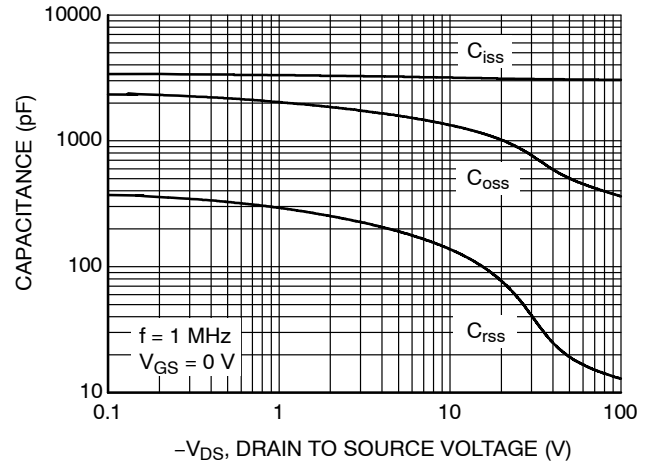

Figure 8. Capacitance vs. Drain to Source Voltage

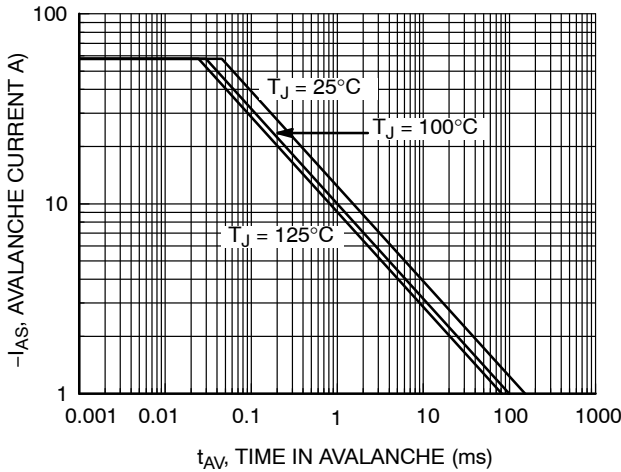

Figure 9. Unclamped Inductive Switching Capability

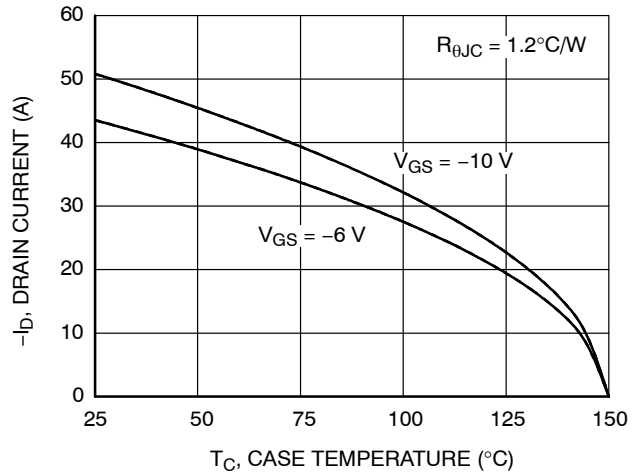

Figure 10. Maximum Continuous Drain Current vs. Case Temperature

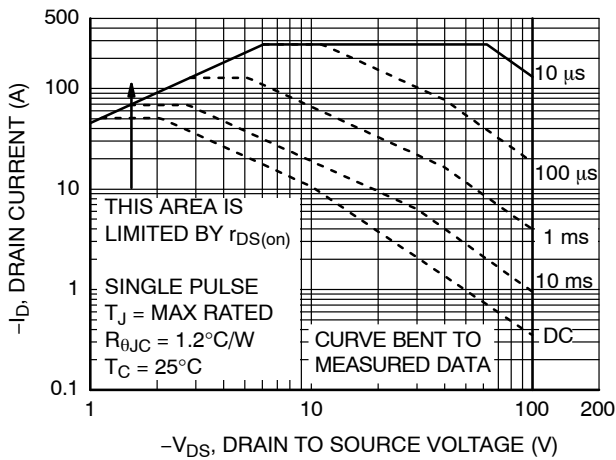

Figure 11. Forward Bias Safe Operating Area

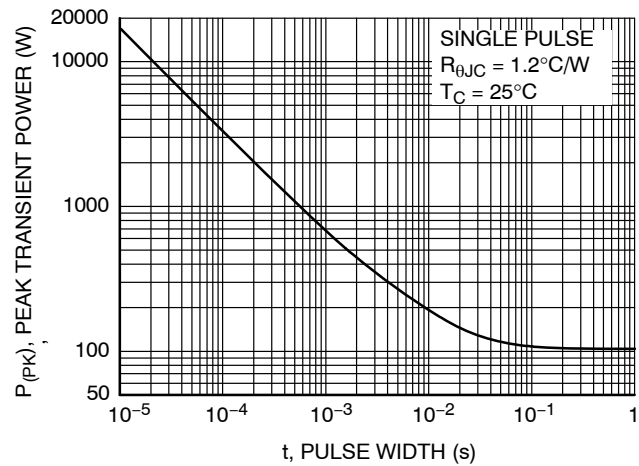

Figure 12. Single Pulse Maximum Power Dissipation

TYPICAL CHARACTERISTICS ( $T_J = 25^\circ\text{C}$  unless otherwise noted) (continued)

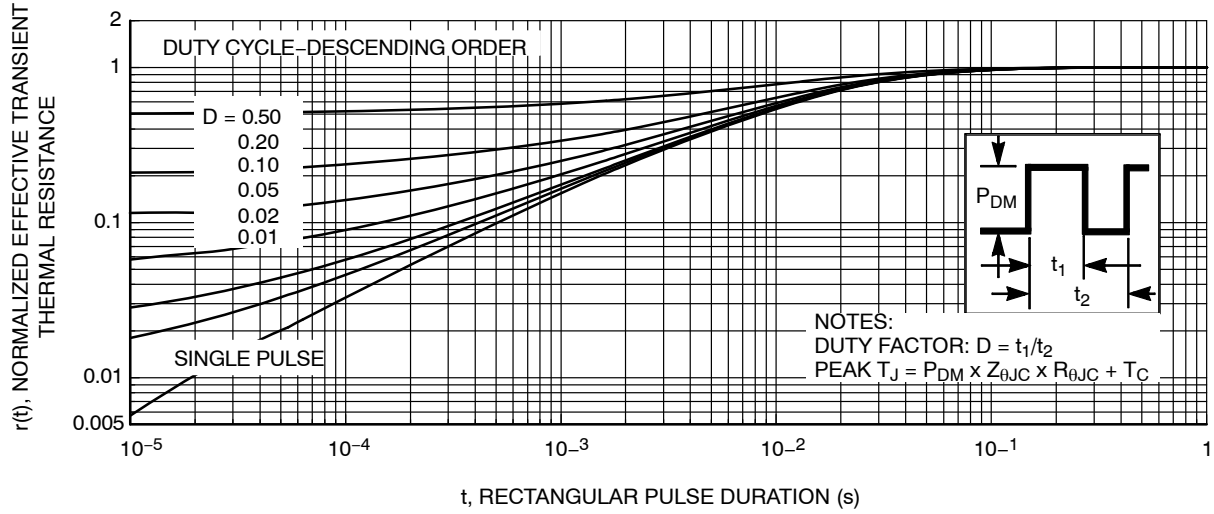
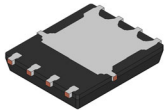

Figure 13. Junction-to-Case Transient Thermal Response Curve

# MECHANICAL CASE OUTLINE PACKAGE DIMENSIONS



**PQFN8 5X6, 1.27P**  
CASE 483AE  
ISSUE C

DATE 21 JAN 2022

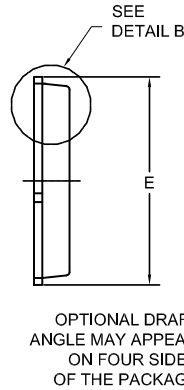
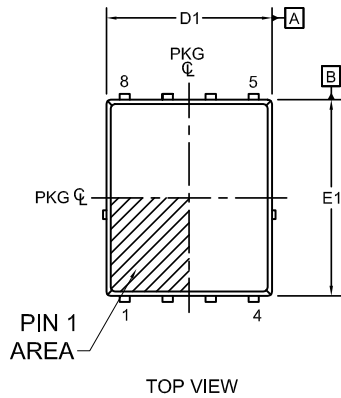

**NOTES:**

1. DIMENSIONING AND TOLERANCING PER ASME Y14.5M, 2009.
2. CONTROLLING DIMENSION: MILLIMETERS
3. COPLANARITY APPLIES TO THE EXPOSED PADS AS WELL AS THE TERMINALS.
4. DIMENSIONS D1 AND E1 DO NOT INCLUDE MOLD FLASH, PROTRUSIONS, OR GATE BURRS.
5. SEATING PLANE IS DEFINED BY THE TERMINALS. "A1" IS DEFINED AS THE DISTANCE FROM THE SEATING PLANE TO THE LOWEST POINT ON THE PACKAGE BODY.
6. IT IS RECOMMENDED TO HAVE NO TRACES OR VIAS WITHIN THE KEEP OUT AREA.

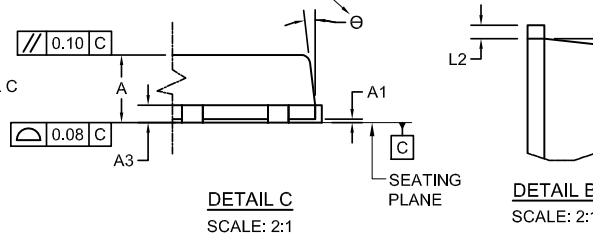
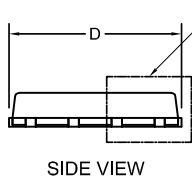

DIM	MILLIMETERS		
	MIN.	NOM.	MAX.
A	0.90	1.00	1.10
A1	0.00	-	0.05
b	0.21	0.31	0.41
b1	0.31	0.41	0.51
A3	0.15	0.25	0.35
D	4.90	5.00	5.20
D1	4.80	4.90	5.00
D2	3.61	3.82	3.96
E	5.90	6.15	6.25
E1	5.70	5.80	5.90
E2	3.38	3.48	3.78
E3	0.30 REF		
E4	0.52 REF		
e	1.27 BSC		
e/2	0.635 BSC		
e1	3.81 BSC		
e2	0.50 REF		
L	0.51	0.66	0.76
L2	0.05	0.18	0.30
L4	0.34	0.44	0.54
z	0.34 REF		
θ	0°	-	12°

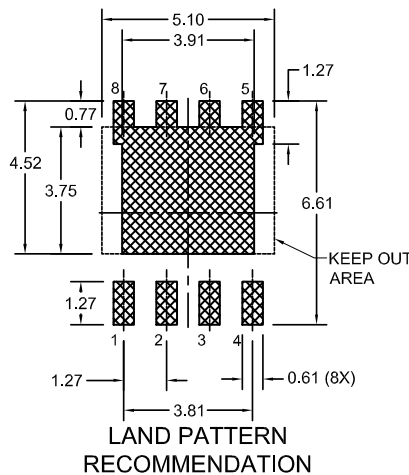
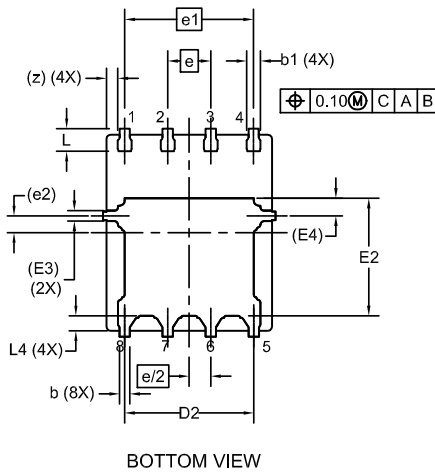

\*FOR ADDITIONAL INFORMATION ON OUR PB-FREE STRATEGY AND SOLDERING DETAILS, PLEASE DOWNLOAD THE ON SEMICONDUCTOR SOLDERING AND MOUNTING TECHNIQUES REFERENCE MANUAL, SOLDERRM/D.

<b>DOCUMENT NUMBER:</b>	<b>98AON13655G</b>	Electronic versions are uncontrolled except when accessed directly from the Document Repository. Printed versions are uncontrolled except when stamped "CONTROLLED COPY" in red.
<b>DESCRIPTION:</b>	<b>PQFN8 5X6, 1.27P</b>	<b>PAGE 1 OF 1</b>

onsemi and ONSEMI are trademarks of Semiconductor Components Industries, LLC dba onsemi or its subsidiaries in the United States and/or other countries. onsemi reserves the right to make changes without further notice to any products herein. onsemi makes no warranty, representation or guarantee regarding the suitability of its products for any particular purpose, nor does onsemi assume any liability arising out of the application or use of any product or circuit, and specifically disclaims any and all liability, including without limitation special, consequential or incidental damages. onsemi does not convey any license under its patent rights nor the rights of others.

**onsemi**, **Onsemi**, and other names, marks, and brands are registered and/or common law trademarks of Semiconductor Components Industries, LLC dba "**onsemi**" or its affiliates and/or subsidiaries in the United States and/or other countries. **onsemi** owns the rights to a number of patents, trademarks, copyrights, trade secrets, and other intellectual property. A listing of **onsemi**'s product/patent coverage may be accessed at [www.onsemi.com/site/pdf/Patent-Marking.pdf](http://www.onsemi.com/site/pdf/Patent-Marking.pdf). **onsemi** reserves the right to make changes at any time to any products or information herein, without notice. The information herein is provided "as-is" and **onsemi** makes no warranty, representation or guarantee regarding the accuracy of the information, product features, availability, functionality, or suitability of its products for any particular purpose, nor does **onsemi** assume any liability arising out of the application or use of any product or circuit, and specifically disclaims any and all liability, including without limitation special, consequential or incidental damages. Buyer is responsible for its products and applications using **onsemi** products, including compliance with all laws, regulations and safety requirements or standards, regardless of any support or applications information provided by **onsemi**. "Typical" parameters which may be provided in **onsemi** data sheets and/or specifications can and do vary in different applications and actual performance may vary over time. All operating parameters, including "Typicals" must be validated for each customer application by customer's technical experts. **onsemi** does not convey any license under any of its intellectual property rights nor the rights of others. **onsemi** products are not designed, intended, or authorized for use as a critical component in life support systems or any FDA Class 3 medical devices or medical devices with a same or similar classification in a foreign jurisdiction or any devices intended for implantation in the human body. Should Buyer purchase or use **onsemi** products for any such unintended or unauthorized application, Buyer shall indemnify and hold **onsemi** and its officers, employees, subsidiaries, affiliates, and distributors harmless against all claims, costs, damages, and expenses, and reasonable attorney fees arising out of, directly or indirectly, any claim of personal injury or death associated with such unintended or unauthorized use, even if such claim alleges that **onsemi** was negligent regarding the design or manufacture of the part. **onsemi** is an Equal Opportunity/Affirmative Action Employer. This literature is subject to all applicable copyright laws and is not for resale in any manner.

## PUBLICATION ORDERING INFORMATION

### LITERATURE FULFILLMENT:

Email Requests to: [orderlit@onsemi.com](mailto:orderlit@onsemi.com)

**onsemi Website:** [www.onsemi.com](http://www.onsemi.com)

### TECHNICAL SUPPORT

**North American Technical Support:**

Voice Mail: 1 800-282-9855 Toll Free USA/Canada

Phone: 011 421 33 790 2910

**Europe, Middle East and Africa Technical Support:**

Phone: 00421 33 790 2910

For additional information, please contact your local Sales Representative



# Mouser Electronics

Authorized Distributor

Click to View Pricing, Inventory, Delivery & Lifecycle Information:

[onsemi:](#)

[FDMS86163P](#)