



CERAMIC

# High Pass Filter

## HFCN-1322+

Mini-Circuits

50Ω 14300 to 18500 MHz

### THE BIG DEAL

- Small size (0.12 x 0.06 x .04")
- Temperature stable
- Excellent power handling, 7W
- Hermetically sealed
- Low cost

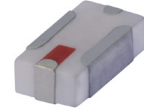

Generic photo used for illustration purposes only

CASE STYLE: FV1206-4

### +RoHS Compliant

The +Suffix identifies RoHS Compliance. See our web site for RoHS Compliance methodologies and qualifications

### APPLICATIONS

- Electronic warfare exciters and receivers
- Sub-harmonic rejection
- Transmitters/receivers
- Lab use

### PRODUCT OVERVIEW

The HFCN-1322+ LTCC high pass filter covers the 14300 to 18500 MHz passband with 1.5 dB passband insertion loss and 28 dB stopband rejection. This model handles up to 7W RF input power and provides a wide operating temperature range from -55 to +100°C. Utilizing LTCC multi-layer construction, the filter achieves excellent repeatability of performance and comes in a tiny 1206 ceramic package with wraparound terminations, minimizing performance variations due to parasitics and saving space in dense PCB layouts.

### KEY FEATURES

Feature	Advantages
LTCC Construction	Provides repeatable performance in a rugged, ceramic package well suited for tough environments such as high humidity and temperature extremes.
Tiny size (0.12 x 0.06 x .04")	Saves space in dense circuit board layouts and minimizes the effects of parasitics.
Wrap-around terminations	Provides excellent solderability and easy visual inspection
Wide operating temperature range, -55 to +100°C	Enables reliable performance in extreme environments

REV. A  
ECO-012120  
HFCN-1322+  
AD/CP/AM  
220302





CERAMIC

# High Pass Filter

## HFCN-1322+

### ELECTRICAL SPECIFICATIONS<sup>1,2</sup> AT 25°C

Parameter	F#	Frequency (MHz)	Min.	Typ.	Max.	Units
Stop Band	DC-F1	DC - 11300	20	28	—	dB
	F1-F2	DC - 11700	15	28	—	
	Freq. Cut-Off	F3	13300	—	3.0	dB
	VSWR	DC-F2	DC - 11700	—	20	:1
Pass Band	F4-F7	14300 - 18500	—	1.75	2.8	dB
	F5-F6	15900 - 17200	—	1.5	2.5	dB
	VSWR	F4-F7	14300 - 18500	—	1.7	:1

1. In Application where DC voltage is present at either input or output ports, coupling capacitors are required.

2. Measured on Mini-Circuits Characterization Test Board TB-860+.

### MAXIMUM RATINGS

Parameter	Ratings
Operating temperature	-55°C to +100°C
Storage temperature	-55°C to +100°C
RF Power Input <sup>3</sup>	7W max. at 25°C

3. Passband rating, derate linearly to 3W at 100°C ambient. Permanent damage may occur if any of these limits are exceeded.

### TYPICAL FREQUENCY RESPONSE

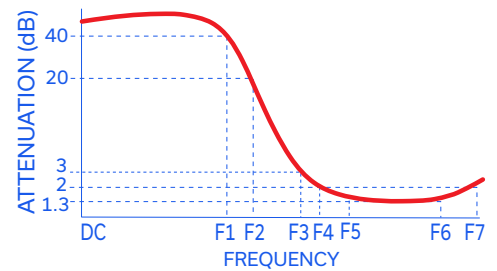

### FUNCTIONAL SCHEMATIC

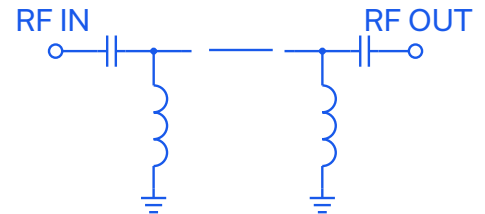



CERAMIC

# High Pass Filter

## HFCN-1322+

### PIN CONNECTIONS

RF IN	1
RF OUT	3
GROUND	2,4

PRODUCT MARKING: FB

DEMO BOARD MCL P/N: TB-860+  
SUGGESTED PCB LAYOUT (PL-487)

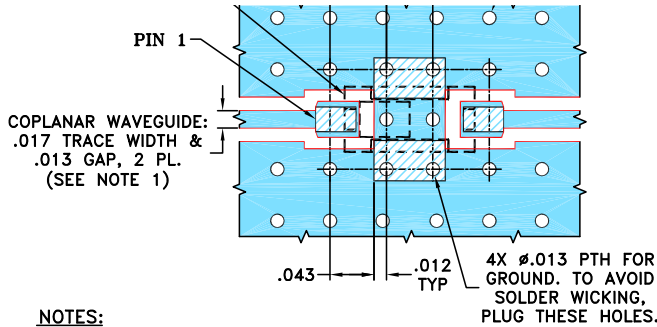

#### NOTES:

- TRACE WIDTH AND GAP ARE SHOWN FOR ROGERS RO4350B WITH DIELECTRIC THICKNESS .010" ± .001". COPPER: 1/2 OZ. EACH SIDE. FOR OTHER MATERIALS TRACE WIDTH AND GAP MAY NEED TO BE MODIFIED.
- BOTTOM SIDE OF THE PCB IS CONTINUOUS GROUND PLANE.

- DENOTES PCB COPPER LAYOUT WITH SMOBC (SOLDER MASK OVER BARE COPPER)
- DENOTES COPPER LAND PATTERN FREE OF SOLDER MASK

### OUTLINE DRAWING

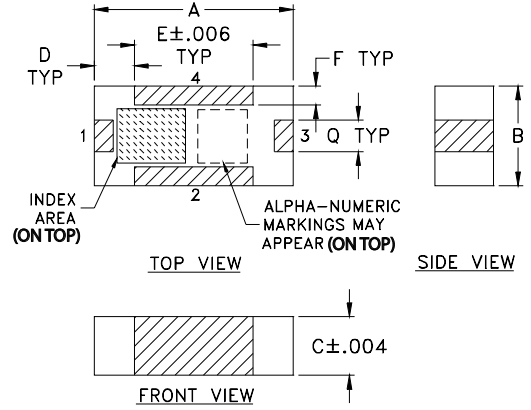

### PCB Land Pattern

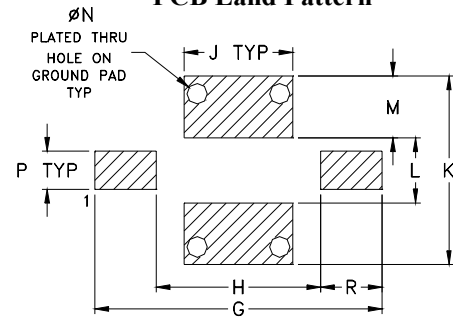

Suggested Layout,  
Tolerance to be within  $\pm .002$

### OUTLINE DIMENSIONS (Inches mm)

A	B	C	D	E	F	G	H	J
.126	.063	.037	.026	.075	.012	.182	.104	.069
3.20	1.60	0.94	0.66	1.91	0.30	4.62	2.64	1.75
K	L	M	N	P	Q	R	wt	
.119	.041	.039	.013	.024	.020	.039	grams	
3.02	1.04	0.99	0.33	0.61	0.51	0.99	.020	

TAPE & REEL INFORMATION: F75



CERAMIC

# High Pass Filter

## HFCN-1322+

### TYPICAL PERFORMANCE DATA AT 25°C

Frequency (MHz)	Insertion Loss (dB)	VSWR :1
10	80.30	369.73
100	52.19	333.37
1000	32.67	193.05
2000	28.29	98.48
5000	26.56	66.05
7000	27.18	51.59
9000	31.24	74.98
11300	34.00	50.49
11700	29.04	36.80
12500	14.10	11.91
13300	3.03	2.12
13800	1.73	1.40
14300	1.56	1.47
15000	1.75	2.02
15900	1.47	1.78
16500	1.08	1.21
17200	1.17	1.38
18500	1.19	1.15

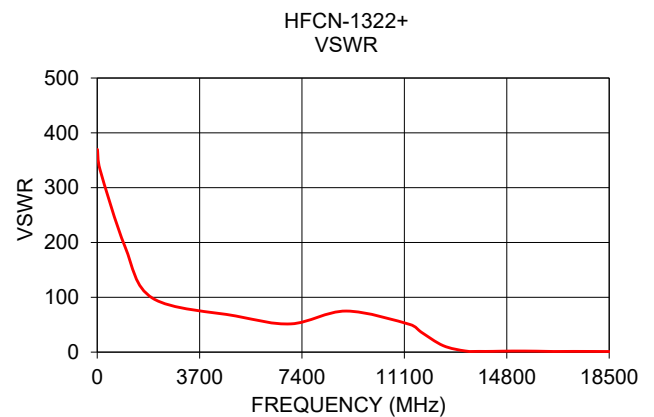
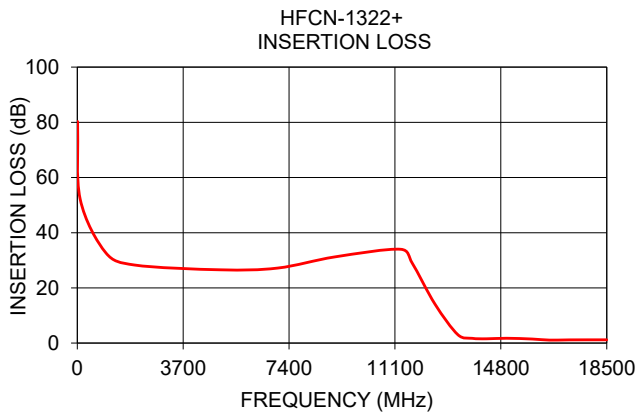

- NOTES**
- A. Performance and quality attributes and conditions not expressly stated in this specification document are intended to be excluded and do not form a part of this specification document.
  - B. Electrical specifications and performance data contained in this specification document are based on Mini-Circuit's applicable established test performance criteria and measurement instructions.
  - C. The parts covered by this specification document are subject to Mini-Circuits standard limited warranty and terms and conditions (collectively, "Standard Terms"); Purchasers of this part are entitled to the rights and benefits contained therein. For a full statement of the standard. Terms and the exclusive rights and remedies thereunder, please visit Mini-Circuits' website at [www.minicircuits.com/MCLStore/terms.jsp](http://www.minicircuits.com/MCLStore/terms.jsp)



# Mouser Electronics

Authorized Distributor

Click to View Pricing, Inventory, Delivery & Lifecycle Information:

[Mini-Circuits:](#)

[HFCN-1322+](#)