

## Microwave Wideband Synthesizer with Integrated VCO

### FEATURES

- ▶ RF output frequency range: 53.125 MHz to 13,600 MHz
  - ▶ Noise floor integer channel:  $-227$  dBc/Hz
  - ▶ Noise floor fractional channel:  $-225$  dBc/Hz
- ▶ Integrated rms jitter (1 kHz to 20 MHz): 97 fs for 6 GHz output
- ▶ Fractional-N synthesizer and integer N synthesizer
- ▶ Pin compatible to the [ADF5355](#)
- ▶ High resolution, 52-bit modulus
- ▶ Phase frequency detector (PFD) operation to 125 MHz
- ▶ Reference input frequency operation to 600 MHz
- ▶ Maintains frequency lock over  $-40^{\circ}\text{C}$  to  $+85^{\circ}\text{C}$
- ▶ Low phase noise, voltage controlled oscillator (VCO)
- ▶ Programmable divide by 1, 2, 4, 8, 16, 32, or 64 output
- ▶ Analog and digital power supplies: 3.3 V
- ▶ Charge pump and VCO power supplies: 5.0 V typical
- ▶ Logic compatibility: 1.8 V
- ▶ Programmable output power level
- ▶ RF output mute function
- ▶ Supported by the [ADIsimPLL](#) design tool

### APPLICATIONS

- ▶ Wireless infrastructure (LTE, W-CDMA, TD-SCDMA, WiMAX, GSM, PCS, DCS)
- ▶ Point to point and point to multipoint microwave links
- ▶ Satellites and very small aperture terminals (VSATs)
- ▶ Test equipment and instrumentation
- ▶ Clock generation

### FUNCTIONAL BLOCK DIAGRAM

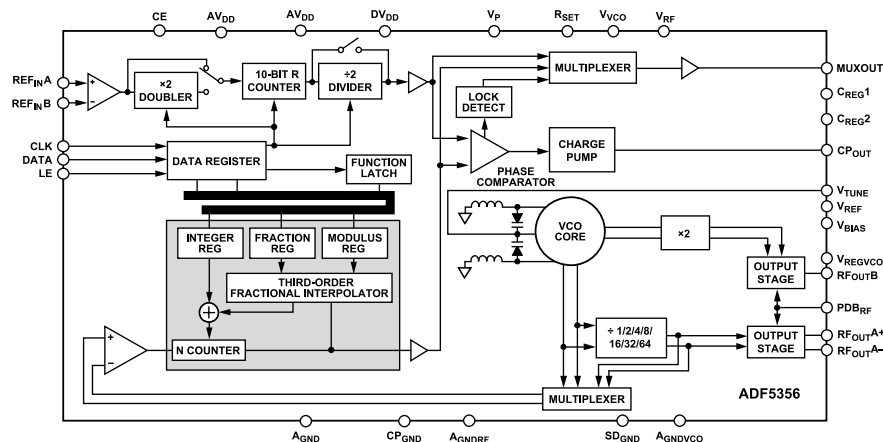

Figure 1.

### GENERAL DESCRIPTION

The ADF5356 allows implementation of fractional-N or integer N phase-locked loop (PLL) frequency synthesizers when used with an external loop filter and an external reference frequency. The wideband microwave VCO design permits frequency operation from 6.8 GHz to 13.6 GHz at one radio frequency (RF) output. A series of frequency dividers at another frequency output permits operation from 53.125 MHz to 6800 MHz.

The ADF5356 has an integrated VCO with a fundamental output frequency ranging from 3400 MHz to 6800 MHz. In addition, the VCO frequency is connected to divide by 1, 2, 4, 8, 16, 32, or 64 circuits that allow the user to generate RF output frequencies as low as 53.125 MHz. For applications that require isolation, the RF output stage can be muted. The mute function is both pin- and software-controllable.

Control of all on-chip registers is through a simple 3-wire interface. The ADF5356 operates with analog and digital power supplies ranging from 3.15 V to 3.45 V, with charge pump and VCO supplies from 4.75 V to 5.25 V. The ADF5356 also contains hardware and software power-down modes.

## TABLE OF CONTENTS

Features.....	1	Register 4.....	26
Applications.....	1	Register 5.....	27
General Description.....	1	Register 6.....	28
Functional Block Diagram.....	1	Register 7.....	30
Specifications.....	3	Register 8.....	32
Timing Characteristics.....	6	Register 9.....	32
Absolute Maximum Ratings.....	7	Register 10.....	33
Thermal Resistance.....	7	Register 11.....	34
Transistor Count.....	7	Register 12.....	34
ESD Caution.....	7	Register 13.....	35
Pin Configuration and Function Descriptions.....	8	Register Initialization Sequence.....	35
Typical Performance Characteristics.....	10	Frequency Update Sequence.....	35
Theory of Operation.....	15	RF Synthesizer—A Worked Example.....	36
Reference Input Section.....	15	Reference Doubler and Reference Divider.....	36
RF N Divider.....	15	Spurious Optimization and Fast Lock.....	36
Phase Frequency Detector (PFD) and Charge Pump.....	16	Optimizing Jitter.....	37
MUXOUT and Lock Detect.....	16	Spur Mechanisms.....	37
Input Shift Registers.....	16	PLL Lock Time.....	37
Program Modes.....	17	Applications Information.....	39
VCO.....	17	Power Supplies.....	39
Output Stage.....	17	PCB Design Guidelines for a Chip Scale Package.....	39
Register Maps.....	19	Output Matching.....	40
Register 0.....	21	Outline Dimensions.....	41
Register 1.....	23	Ordering Guide.....	41
Register 2.....	23	Evaluation Boards.....	41
Register 3.....	24		

## REVISION HISTORY

**3/2023—Rev. 0 to Rev. A**

Changes to RF <sub>OUTB</sub> Output Frequency Parameter and RF <sub>OUTA+</sub> /RF <sub>OUTA-</sub> Output Frequency Parameter, Table 1.....	3
Changes to Prescaler Value Section.....	21
Changes to RF Synthesizer—A Worked Example Section.....	36

**8/2017—Revision 0: Initial Version**

## SPECIFICATIONS

$AV_{DD} = DV_{DD} = V_{RF} = 3.3 \text{ V} \pm 5\%$ ,  $4.75 \text{ V} \leq V_P = V_{VCO} \leq 5.25 \text{ V}$ ,  $A_{GND} = CP_{GND} = A_{GNDVCO} = SD_{GND} = A_{GNDRF} = 0 \text{ V}$ ,  $R_{SET} = 5.1 \text{ k}\Omega$ , dBm referred to  $50 \Omega$ ,  $T_A = T_{MIN}$  to  $T_{MAX}$ , unless otherwise noted.

Table 1.

Parameter	Symbol	Min	Typ	Max	Unit	Test Conditions/Comments
<b>REF<sub>IN</sub>A/REF<sub>IN</sub>B CHARACTERISTICS</b>						
Input Frequency Range						For $f < 10 \text{ MHz}$ , ensure slew rate $> 21 \text{ V}/\mu\text{s}$
Single-Ended Mode		10		250	MHz	
Differential Mode		10		600	MHz	
Input Sensitivity						
Single-Ended Mode		0.4		$AV_{DD}$	V p-p	REF <sub>IN</sub> A biased at $AV_{DD}/2$ ; ac coupling ensures $AV_{DD}/2$ bias
Differential Mode		0.4		1.8	V p-p	Low voltage differential signaling (LVDS) and Low voltage positive emitter-coupled logic (LVPECL) compatible, REF <sub>IN</sub> A/REF <sub>IN</sub> B biased at 2.1 V; ac coupling ensures 2.1 V bias
Input Capacitance						
Single-Ended Mode			6.9		pF	
Differential Mode			1.4		pF	
Input Current				$\pm 100$	$\mu\text{A}$	Single-ended reference programmed
				$\pm 250$	$\mu\text{A}$	Differential reference programmed
PFD				125	MHz	
<b>CHARGE PUMP (CP)</b>						
CP Current, Sink/Source	$I_{CP}$					$R_{SET} = 5.1 \text{ k}\Omega$ , this resistor is internal in the ADF5356
High Value			4.8		mA	
Low Value			0.3		mA	
$R_{SET}$ Range			5.1		k $\Omega$	Fixed
Current Matching			3		%	$0.5 \text{ V} \leq V_{CP}^1 \leq V_P - 0.5 \text{ V}$
$I_{CP}$ vs. $V_{CP}$			3		%	$0.5 \text{ V} \leq V_{CP}^1 \leq V_P - 0.5 \text{ V}$
$I_{CP}$ vs. Temperature			1.5		%	$V_{CP}^1 = 2.5 \text{ V}$
<b>LOGIC INPUTS</b>						
Input Voltage						
High	$V_{INH}$	1.5		$DV_{DD}$	V	
Low	$V_{INL}$			0.6	V	
Input Current, High/Low	$I_{INH}/I_{INL}$			$\pm 1$	$\mu\text{A}$	
Input Capacitance	$C_{IN}$		3.0		pF	
<b>LOGIC OUTPUTS</b>						
Output High Voltage	$V_{OH}$	$DV_{DD} - 0.4$			V	3.3 V output selected
		1.5	1.8		V	1.8 V output selected
Output High Current	$I_{OH}$			500	$\mu\text{A}$	
Output Low Voltage	$V_{OL}$			0.4	V	$I_{OL}^2 = 500 \mu\text{A}$
<b>POWER SUPPLIES</b>						
Analog Power	$AV_{DD}$	3.15	3.3	3.45	V	See Table 7
Digital Power and RF Supply Voltage	$DV_{DD}, V_{RF}$		$AV_{DD}$			Voltages must equal $AV_{DD}$
CP and VCO Supply Voltage	$V_P, V_{VCO}$	4.75	5.0	5.25	V	$V_P$ must equal $V_{VCO}$
Total Digital and Analog Current, $DI_{DD} + AI_{DD}^3$			82	92	mA	
Output Dividers			6 to 36		mA	Each output divide by 2 consumes 6 mA
CP Supply Power Current	$I_P$		8	9	mA	For maximum $I_{CP} = 4.8 \text{ mA}$
Supply Current	$I_{VCO}$		70	90	mA	

## SPECIFICATIONS

Table 1. (Continued)

Parameter	Symbol	Min	Typ	Max	Unit	Test Conditions/Comments
RF <sub>OUTA+</sub> /RF <sub>OUTA-</sub> and RF <sub>OUTB</sub> Supply Current	I <sub>RFOUTx±</sub>		12	15	mA	RF Output A and RF Output B enabled; RF Output A is programmable; enabling RF Output B draws negligible extra current
			24	29	mA	-4 dBm setting
			35	42	mA	-1 dBm setting
			46	56	mA	2 dBm setting
						5 dBm setting
Low Power Sleep Mode			5		mA	Hardware power-down selected
			20		mA	Software power-down selected
RF OUTPUT CHARACTERISTICS						
VCO Frequency Range		3400		6800	MHz	Fundamental VCO range
RF <sub>OUTB</sub> Output Frequency		6800		13600	MHz	2× VCO output (RF <sub>OUTB</sub> ), prescaler = 8/9
		6800		13600	MHz	2× VCO output (RF <sub>OUTB</sub> ), prescaler = 4/5, divided feedback to N counter with output divider ≥ 2
RF <sub>OUTA+</sub> /RF <sub>OUTA-</sub> Output Frequency		6800		12000	MHz	2× VCO output (RF <sub>OUTB</sub> ), prescaler = 4/5, fundamental feedback to N counter, T <sub>A</sub> ≥ 25°C
		6800		11400	MHz	2× VCO output (RF <sub>OUTB</sub> ), prescaler = 4/5, fundamental feedback to N counter
		53.125		6800	MHz	Prescaler = 8/9
RF <sub>OUTA+</sub> /RF <sub>OUTA-</sub> Output Frequency		53.125		6000	MHz	Prescaler = 4/5, T <sub>A</sub> ≥ 25°C
		53.125		5700	MHz	Prescaler = 4/5
VCO Sensitivity	K <sub>V</sub>		25		MHz/V	
Frequency Pushing (Open Loop)			12		MHz/V	
Frequency Pulling (Open Loop)			0.5		MHz	Voltage standing wave ratio (VSWR) = 2:1 RF <sub>OUTA</sub> /RF <sub>OUTA-</sub>
Harmonic Content			30		MHz	VSWR = 2:1 RF <sub>OUTB</sub>
	Second		-26		dBc	Fundamental VCO output (RF <sub>OUTA+</sub> )
Third			-29		dBc	Divided VCO output (RF <sub>OUTA+</sub> )
			-32		dBc	Fundamental VCO output (RF <sub>OUTA+</sub> )
Fundamental VCO Feedthrough			-14		dBc	Divided VCO output (RF <sub>OUTA+</sub> )
			-10		dBm	RF <sub>OUTB</sub> = 10 GHz
RF Output Power <sup>4</sup>			8		dBm	RF <sub>OUTA+</sub> = 1 GHz; 7.4 nH inductor to V <sub>RF</sub>
			-1		dBm	RF <sub>OUTA+</sub> = 6.8 GHz; 7.4 nH inductor to V <sub>RF</sub>
			0		dBm	RF <sub>OUTB</sub> = 6.8 GHz
			2		dBm	RF <sub>OUTB</sub> = 13.6 GHz
Variation			±1		dB	RF <sub>OUTA+</sub> = 5 GHz
			±1		dB	RF <sub>OUTB</sub> = 10 GHz
Variation over Frequency			±5		dB	RF <sub>OUTA+</sub> = 1 GHz to 6.8 GHz
			±3		dB	RF <sub>OUTB</sub> = 6.8 GHz to 13.6 GHz
Level of Signal with RF Output Disabled			-53		dBm	RF <sub>OUTA+</sub> = 1 GHz
			-20		dBm	RF <sub>OUTA+</sub> = 6.8 GHz
			-16		dBm	RF <sub>OUTB</sub> = 6.8 GHz
			-12		dBm	RF <sub>OUTB</sub> = 13.6 GHz

## SPECIFICATIONS

Table 1. (Continued)

Parameter	Symbol	Min	Typ	Max	Unit	Test Conditions/Comments
<b>NOISE CHARACTERISTICS</b>						
Fundamental VCO Phase Noise Performance						VCO noise in open-loop conditions
			-115		dBc/Hz	100 kHz offset from 3.4 GHz carrier
			-135		dBc/Hz	800 kHz offset from 3.4 GHz carrier
			-137		dBc/Hz	1 MHz offset from 3.4 GHz carrier
			-155		dBc/Hz	10 MHz offset from 3.4 GHz carrier
			-113		dBc/Hz	100 kHz offset from 5.0 GHz carrier
			-133		dBc/Hz	800 kHz offset from 5.0 GHz carrier
			-135		dBc/Hz	1 MHz offset from 5.0 GHz carrier
			-153		dBc/Hz	10 MHz offset from 5.0 GHz carrier
			-110		dBc/Hz	100 kHz offset from 6.8 GHz carrier
			-130		dBc/Hz	800 kHz offset from 6.8 GHz carrier
			-132		dBc/Hz	1 MHz offset from 6.8 GHz carrier
			-150		dBc/Hz	10 MHz offset from 6.8 GHz carrier
VCO 2× Phase Noise Performance						VCO noise in open-loop conditions
			-110		dBc/Hz	100 kHz offset from 6.8 GHz carrier
			-130		dBc/Hz	800 kHz offset from 6.8 GHz carrier
			-132		dBc/Hz	1 MHz offset from 6.8 GHz carrier
			-149		dBc/Hz	10 MHz offset from 6.8 GHz carrier
			-107		dBc/Hz	100 kHz offset from 10 GHz carrier
			-127		dBc/Hz	800 kHz offset from 10 GHz carrier
			-129		dBc/Hz	1 MHz offset from 10 GHz carrier
			-147		dBc/Hz	10 MHz offset from 10 GHz carrier
			-103		dBc/Hz	100 kHz offset from 13.6 GHz carrier
			-124		dBc/Hz	800 kHz offset from 13.6 GHz carrier
			-126		dBc/Hz	1 MHz offset from 13.6 GHz carrier
			-144		dBc/Hz	10 MHz offset from 13.6 GHz carrier
Normalized In-Band Phase Noise Floor						
Fractional Channel <sup>5</sup>			-225		dBc/Hz	
Integer Channel <sup>6</sup>			-227		dBc/Hz	
Normalized 1/f Noise, $PN_{1/f}$ <sup>7</sup>			-121		dBc/Hz	10 kHz offset; normalized to 1 GHz
Integrated RMS Jitter (1 kHz to 20 MHz) <sup>8</sup>			97		fs	
Spurious Signals Due to PFD Frequency			-85		dBc	

<sup>1</sup>  $V_{CP}$  is the voltage at the  $CP_{OUT}$  pin.

<sup>2</sup>  $I_{OL}$  is the output low current.

<sup>3</sup>  $T_A = 25^\circ\text{C}$ ;  $AV_{DD} = DV_{DD} = V_{RF} = 3.3\text{ V}$ ;  $V_{VCO} = V_P = 5.0\text{ V}$ ; prescaler = 8/9;  $f_{REFIN} = 122.88\text{ MHz}$ ;  $f_{PFD} = 61.44\text{ MHz}$ ; and  $f_{RF} = 1650\text{ MHz}$ .

<sup>4</sup> RF output power using the EV-ADF5356SD1Z evaluation board is measured by a spectrum analyzer, with board and cable losses de-embedded. Unused RF output pins are terminated into 50  $\Omega$ .

<sup>5</sup> Use this value to calculate the phase noise for any application. To calculate in-band phase noise performance as seen at the VCO output, use the following formula:  $-225 + 10\log(f_{PFD}) + 20\log N$ . The value given is the lowest noise mode for the fractional channel.

<sup>6</sup> Use this value to calculate the phase noise for any application. To calculate in-band phase noise performance as seen at the VCO output, use the following formula:  $-227 + 10\log(f_{PFD}) + 20\log N$ . The value given is the lowest noise mode for the integer channel.

<sup>7</sup> The PLL phase noise is composed of 1/f (flicker) noise plus the normalized PLL noise floor. The formula for calculating the 1/f noise contribution at an RF frequency ( $f_{RF}$ ) and at a frequency offset ( $f$ ) is given by  $PN = P_{1/f} + 10\log(10\text{ kHz}/f) + 20\log(f_{RF}/1\text{ GHz})$ . Both the normalized phase noise floor and flicker noise are modeled in the [ADIsimPLL](#) design tool.

## SPECIFICATIONS

<sup>8</sup> Integrated rms jitter using the EV-ADF5356SD1Z evaluation board is measured by a spectrum analyzer. The EV-ADF5356SD1Z evaluation board is configured to accept a single-ended REF<sub>IN</sub> signal (SMA 100) = 160 MHz, VCO frequency = 6 GHz, f<sub>PFD</sub> = 80 MHz, charge pump current = 0.9 mA, with bleed current off. The loop filter is configured for an 80 kHz loop filter bandwidth. Unused RF output pins are terminated into 50 Ω.

## TIMING CHARACTERISTICS

$A_{V_{DD}} = DV_{DD} = V_{RF} = 3.3 \text{ V} \pm 5\%$ ,  $4.75 \text{ V} \leq V_P = V_{VCO} \leq 5.25 \text{ V}$ ,  $A_{GND} = CP_{GND} = A_{GNDVCO} = SD_{GND} = A_{GNDRF} = 0 \text{ V}$ ,  $R_{SET} = 5.1 \text{ k}\Omega$ , dBm referred to 50 Ω,  $T_A = T_{MIN}$  to  $T_{MAX}$ , unless otherwise noted.

Table 2. Write Timing

Parameter	Limit	Unit	Description
f <sub>CLK</sub>	50	MHz max	Serial peripheral interface (SPI) CLK frequency
t <sub>1</sub>	10	ns min	LE setup time
t <sub>2</sub>	5	ns min	DATA to CLK setup time
t <sub>3</sub>	5	ns min	DATA to CLK hold time
t <sub>4</sub>	10	ns min	CLK high duration
t <sub>5</sub>	10	ns min	CLK low duration
t <sub>6</sub>	10	ns min	CLK to LE setup time
t <sub>7</sub>	20 or (2/f <sub>PFD</sub> ), whichever is longer	ns min	LE pulse width

## Write Timing Diagram

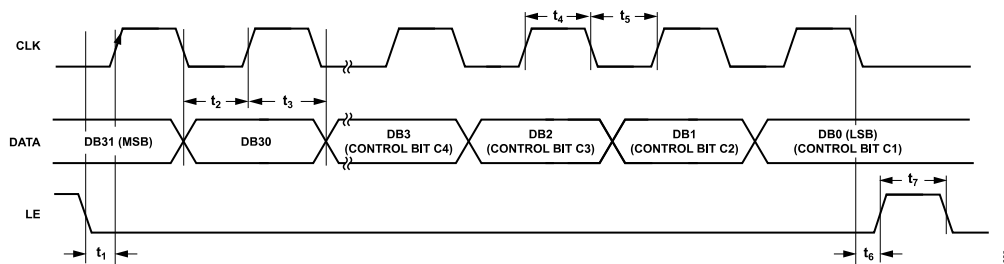

Figure 2. Write Timing Diagram

## ABSOLUTE MAXIMUM RATINGS

$T_A = 25^\circ\text{C}$ , unless otherwise noted.

**Table 3.**

Parameter	Rating
$V_{RF}$ , $DV_{DD}$ , $AV_{DD}$ to GND <sup>1</sup>	-0.3 V to +3.6 V
$AV_{DD}$ to $DV_{DD}$	-0.3 V to +0.3 V
$V_P$ , $V_{VCO}$ to GND <sup>1</sup>	-0.3 V to +5.8 V
$CP_{OUT}$ to GND <sup>1</sup>	-0.3 V to $V_P + 0.3$ V
Digital Input/Output Voltage to GND <sup>1</sup>	-0.3 V to $DV_{DD} + 0.3$ V
Analog Input/Output Voltage to GND <sup>1</sup>	-0.3 V to $AV_{DD} + 0.3$ V
$REF_{IN,A}$ , $REF_{IN,B}$ to GND <sup>1</sup>	-0.3 V to $AV_{DD} + 0.3$ V
$REF_{IN,A}$ to $REF_{IN,B}$	$\pm 2.1$ V
Operating Temperature Range	$-40^\circ\text{C}$ to $+85^\circ\text{C}$
Storage Temperature Range	$-65^\circ\text{C}$ to $+125^\circ\text{C}$
Maximum Junction Temperature	$150^\circ\text{C}$
Reflow Soldering	
Peak Temperature	$260^\circ\text{C}$
Time at Peak Temperature	40 sec
Electrostatic Discharge (ESD)	
Charged Device Model	500 V
Human Body Model	2000 V

<sup>1</sup>  $GND = A_{GND} = SD_{GND} = A_{GNDRF} = A_{GNDVCO} = CP_{GND} = 0$  V.

Stresses at or above those listed under Absolute Maximum Ratings may cause permanent damage to the product. This is a stress rating only; functional operation of the product at these or any other conditions above those indicated in the operational section of this specification is not implied. Operation beyond the maximum operating conditions for extended periods may affect product reliability.

The ADF5356 is a high performance RF integrated circuit with an ESD rating of 2 kV and is ESD sensitive. Take proper precautions for handling and assembly.

## THERMAL RESISTANCE

Thermal performance is directly linked to printed circuit board (PCB) design and operating environment. Careful attention to PCB thermal design is required.  $\theta_{JA}$  is the natural convection junction to ambient thermal resistance measured in a one cubic foot sealed enclosure.

**Table 4. Thermal Resistance**

Package Type	$\theta_{JA}$	Unit
CP-32-12 <sup>1</sup>	27.3	$^\circ\text{C/W}$

<sup>1</sup> Thermal impedance simulated values are based on use of a PCB with the thermal impedance pad soldered to GND ( $GND = A_{GND} = SD_{GND} = A_{GNDRF} = A_{GNDVCO} = CP_{GND} = 0$  V).

## TRANSISTOR COUNT

The transistor count for the ADF5356 is 134,486 (CMOS) and 3874 (bipolar).

## ESD CAUTION



**ESD (electrostatic discharge) sensitive device.** Charged devices and circuit boards can discharge without detection. Although this product features patented or proprietary protection circuitry, damage may occur on devices subjected to high energy ESD. Therefore, proper ESD precautions should be taken to avoid performance degradation or loss of functionality.

## PIN CONFIGURATION AND FUNCTION DESCRIPTIONS

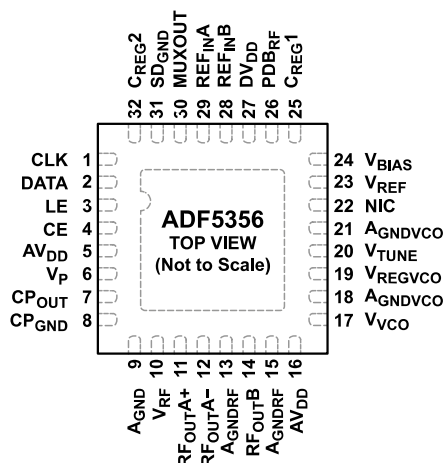

## NOTES

1. NIC = NO INTERNAL CONNECTION. FOR EXISTING DESIGNS THAT CURRENTLY USE THE ADF5355, TO UPGRADE TO THE ADF5356, THE  $R_{SET}$  RESISTOR CAN BE LEFT CONNECTED TO THIS PIN.
2. THE EXPOSED PAD MUST BE CONNECTED TO  $A_{GND}$ .

003

Figure 3. Pin Configuration

Table 5. Pin Function Descriptions

Pin No.	Mnemonic	Description
1	CLK	Serial Clock Input. Data is clocked into the 32-bit shift register on the CLK rising edge. This input is a high impedance CMOS input.
2	DATA	Serial Data Input. The serial data is loaded most significant bit (MSB) first with the four LSBs as the control bits. This input is a high impedance CMOS input.
3	LE	Load Enable, CMOS Input. When LE goes high, the data stored in the shift register is loaded into the register that is selected by the four LSBs.
4	CE	Chip Enable. A logic low on this pin powers down the device and puts the charge pump into three-state mode. A logic high on this pin powers up the device, depending on the status of the power-down bits.
5, 16	$AV_{DD}$	Analog Power Supplies. These pins range from 3.15 V to 3.45 V. Connect decoupling capacitors to the analog ground plane as close to these pins as possible. $AV_{DD}$ must have the same value as $DV_{DD}$ .
6	$V_P$	Charge Pump Power Supply. $V_P$ must have the same value as $V_{VCO}$ . Connect decoupling capacitors to the ground plane as close to this pin as possible.
7	$CP_{OUT}$	Charge Pump Output. When enabled, this output provides $\pm I_{CP}$ to the external loop filter. The output of the loop filter is connected to $V_{TUNE}$ to drive the internal VCO.
8	$CP_{GND}$	Charge Pump Ground. This output is the ground return pin for $CP_{OUT}$ .
9	$A_{GND}$	Analog Ground. This pin is the ground return pin for $AV_{DD}$ .
10	$V_{RF}$	Power Supply for the RF Output. Connect decoupling capacitors to the analog ground plane as close to this pin as possible. $V_{RF}$ must have the same value as $AV_{DD}$ .
11	$RF_{OUTA+}$	VCO Output. The output level is programmable. The VCO fundamental output, or a divided down version, is available.
12	$RF_{OUTA-}$	Complementary VCO Output. The output level is programmable. The VCO fundamental output, or a divided down version, is available.
13, 15	$A_{GNDRF}$	RF Output Stage Ground. This pin is the ground return pin for the RF output stage.
14	$RF_{OUTB}$	Auxiliary VCO Output. The $2\times$ VCO output is available at this pin.
17	$V_{VCO}$	Power Supply for the VCO. The voltage on this pin ranges from 4.75 V to 5.25 V. Place decoupling capacitors to the analog ground plane as close to this pin as possible.
18, 21	$A_{GNDVCO}$	VCO Ground. This pin is the ground return path for the VCO.
19	$V_{REGVCO}$	VCO Compensation Node. Connect decoupling capacitors to the ground plane as close to this pin as possible. Connect $V_{REGVCO}$ directly to $V_{VCO}$ .
20	$V_{TUNE}$	Control Input to the VCO. This voltage determines the output frequency and is derived from filtering the $CP_{OUT}$ output voltage. The capacitance at this pin ( $V_{TUNE}$ input capacitance) is 9 pF.
22	NIC	No Internal Connection. For existing designs that currently use the ADF5355, to upgrade to the ADF5356, the $R_{SET}$ resistor can be left connected to this pin.



## PIN CONFIGURATION AND FUNCTION DESCRIPTIONS

Table 5. Pin Function Descriptions (Continued)

Pin No.	Mnemonic	Description
23	V <sub>REF</sub>	Internal Compensation Node. This pin is dc biased at half the tuning range. Connect decoupling capacitors to the ground plane as close to this pin as possible.
24	V <sub>BIAS</sub>	Reference Voltage. Connect a 100 nF decoupling capacitor to the ground plane as close to this pin as possible.
25, 32	C <sub>REG1</sub> , C <sub>REG2</sub>	Outputs from the LDO Regulator. C <sub>REG1</sub> and C <sub>REG2</sub> are the supply voltages to the digital circuits. These pins have a nominal voltage of 1.8 V. Decoupling capacitors of 100 nF connected to A <sub>GND</sub> are required for these pins.
26	PDB <sub>RF</sub>	RF Power-Down. A logic low on this pin mutes the RF outputs. This mute function is also software controllable. Do not leave this pin floating.
27	DV <sub>DD</sub>	Digital Power Supply. This pin must be at the same voltage as AV <sub>DD</sub> . Place decoupling capacitors to the ground plane as close to this pin as possible.
28	REF <sub>INB</sub>	Complementary Reference Input. If unused, ac couple this pin to A <sub>GND</sub> .
29	REF <sub>INA</sub>	Reference Input.
30	MUXOUT	Multiplexer Output. The multiplexer output allows the digital lock detect, the analog lock detect, scaled RF, or the scaled reference frequency to be externally accessible.
31	SD <sub>GND</sub>	Digital $\Sigma$ - $\Delta$ Modulator Ground. SD <sub>GND</sub> is the ground return path for the $\Sigma$ - $\Delta$ modulator.
	EP	Exposed Pad. The exposed pad must be connected to A <sub>GND</sub> .

TYPICAL PERFORMANCE CHARACTERISTICS

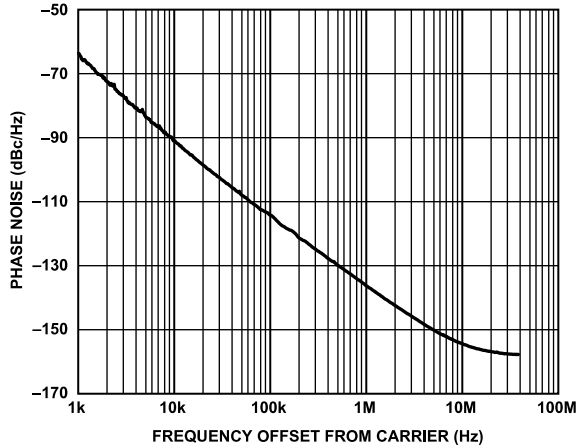

Figure 4. Open-Loop VCO Phase Noise, 3.4 GHz

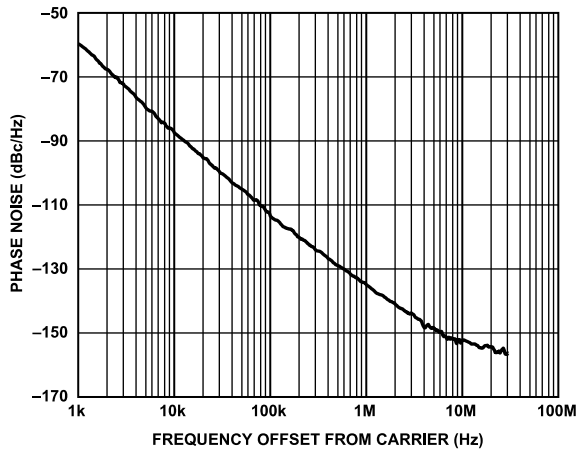

Figure 5. Open-Loop VCO Phase Noise, 5.0 GHz

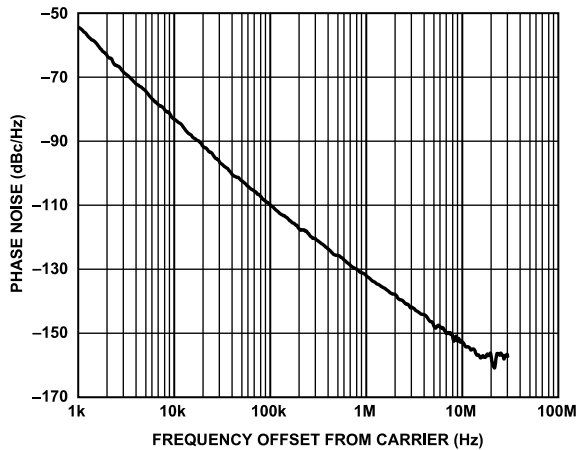

Figure 6. Open-Loop VCO Phase Noise, 6.8 GHz

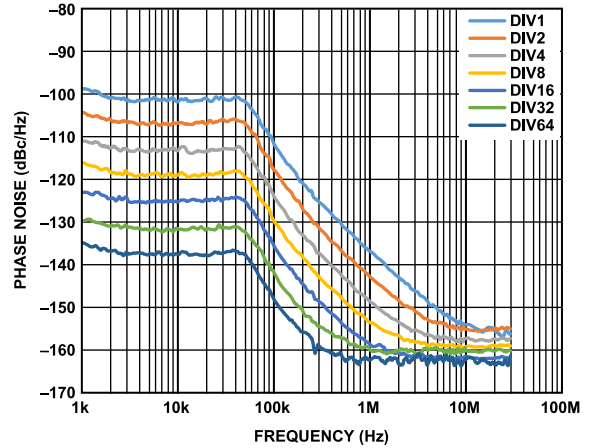

Figure 7. Closed-Loop Phase Noise,  $RF_{OUTA+}$  (100 nH Inductors), Fundamental VCO and Dividers, VCO = 3.4 GHz, PFD = 61.44 MHz, Loop Bandwidth = 40 kHz

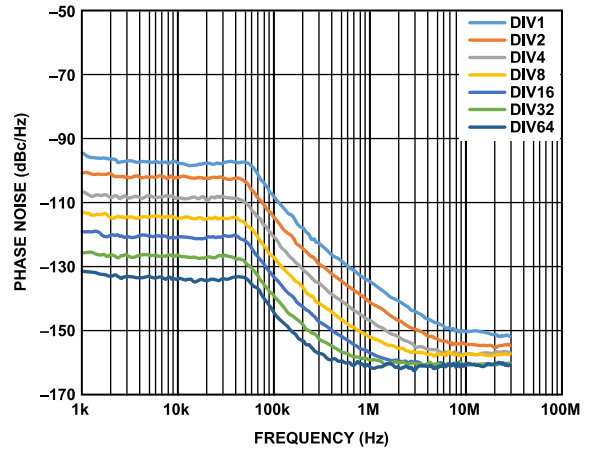

Figure 8. Closed-Loop Phase Noise,  $RF_{OUTA+}$  (100 nH Inductors), Fundamental VCO and Dividers, VCO = 5.0 GHz, PFD = 61.44 MHz, Loop Bandwidth = 40 kHz

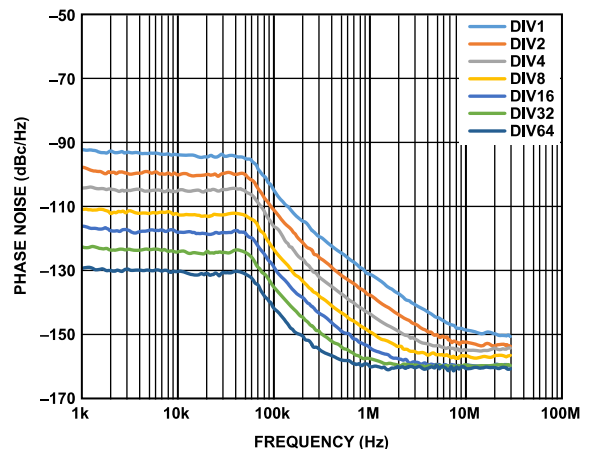

Figure 9. Closed-Loop Phase Noise,  $RF_{OUTA+}$  (100 nH Inductors), Fundamental VCO and Dividers, VCO = 6.8 GHz, PFD = 61.44 MHz, Loop Bandwidth = 40 kHz

TYPICAL PERFORMANCE CHARACTERISTICS

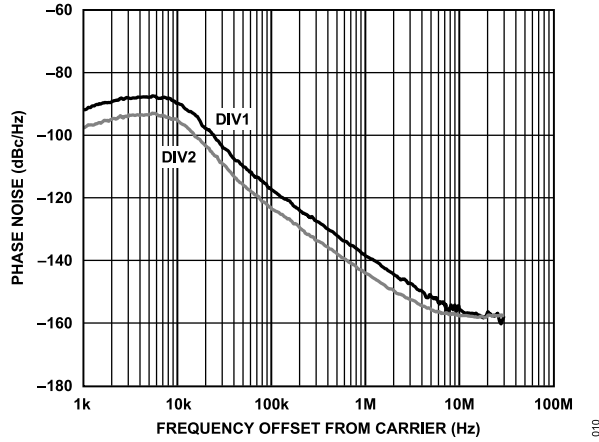

Figure 10. Closed-Loop Phase Noise,  $RF_{OUTA+}$ , Fundamental VCO and Divide by 2, VCO = 3.4 GHz,  $f_{PPD}$  = 61.44 MHz, Loop Bandwidth = 10 kHz

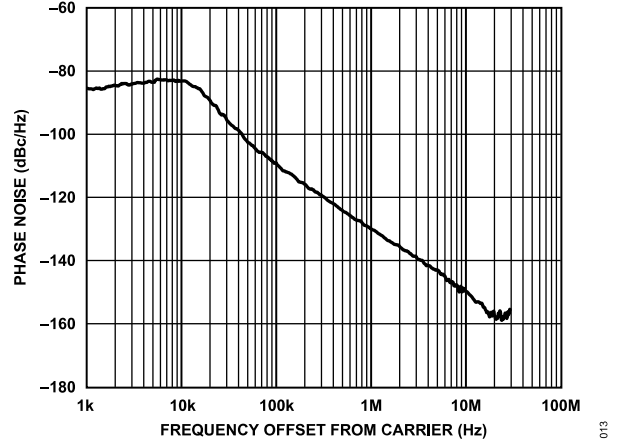

Figure 13. Closed-Loop Phase Noise,  $RF_{OUTB}$  = 6.8 GHz, 2x VCO, VCO = 3.4 GHz,  $f_{PPD}$  = 61.44 MHz, Loop Bandwidth = 10 kHz

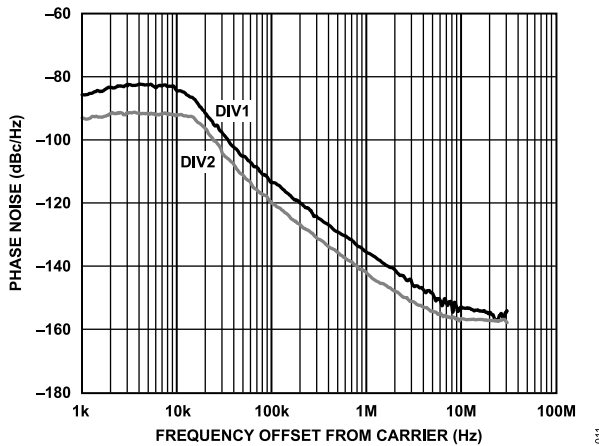

Figure 11. Closed-Loop Phase Noise,  $RF_{OUTA+}$ , Fundamental VCO and Divide by 2, VCO = 5.0 GHz,  $f_{PPD}$  = 61.44 MHz, Loop Bandwidth = 10 kHz

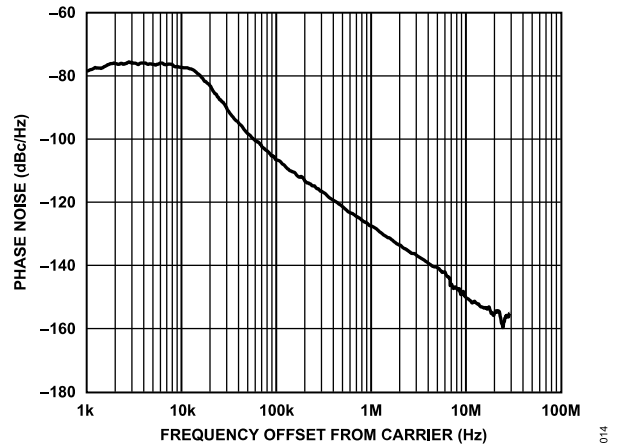

Figure 14. Closed-Loop Phase Noise,  $RF_{OUTB}$  = 10 GHz, 2x VCO, VCO = 5.0 GHz,  $f_{PPD}$  = 61.44 MHz, Loop Bandwidth = 10 kHz

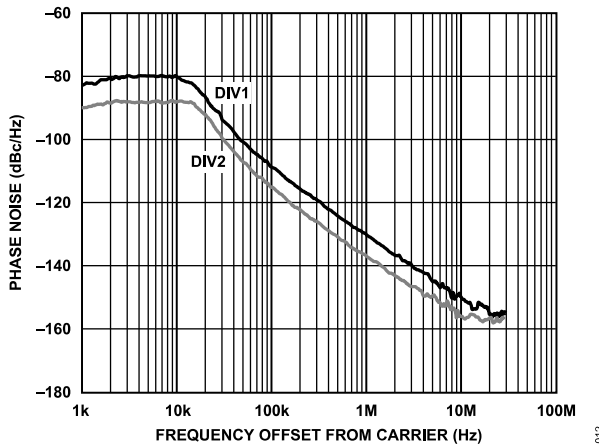

Figure 12. Closed-Loop Phase Noise,  $RF_{OUTA+}$ , Fundamental VCO and Divide by 2, VCO = 6.8 GHz,  $f_{PPD}$  = 61.44 MHz, Loop Bandwidth = 10 kHz

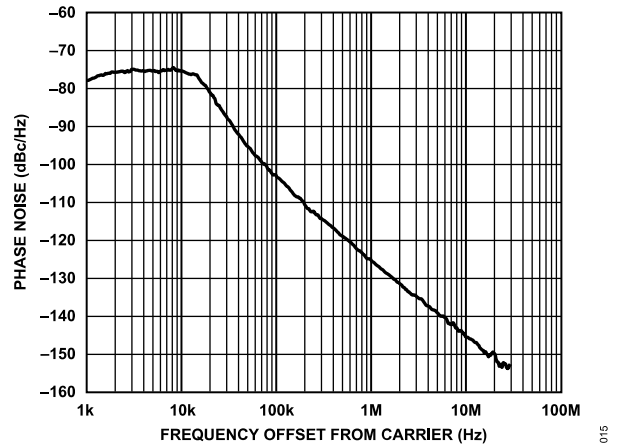

Figure 15. Closed-Loop Phase Noise,  $RF_{OUTB}$  = 13.6 GHz, 2x VCO, VCO = 6.8 GHz,  $f_{PPD}$  = 61.44 MHz, Loop Bandwidth = 10 kHz

TYPICAL PERFORMANCE CHARACTERISTICS

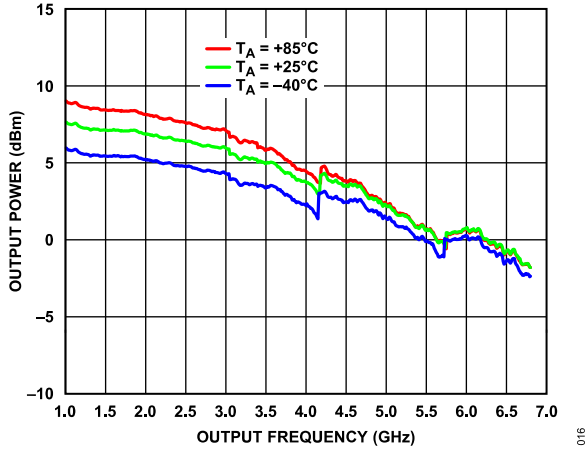

Figure 16.  $RF_{OUTA+}/RF_{OUTA-}$  Output Power vs. Output Frequency, (7.4 nH Inductors, 10 pF AC Coupling Capacitors, Board and Cable Losses De-Embedded)

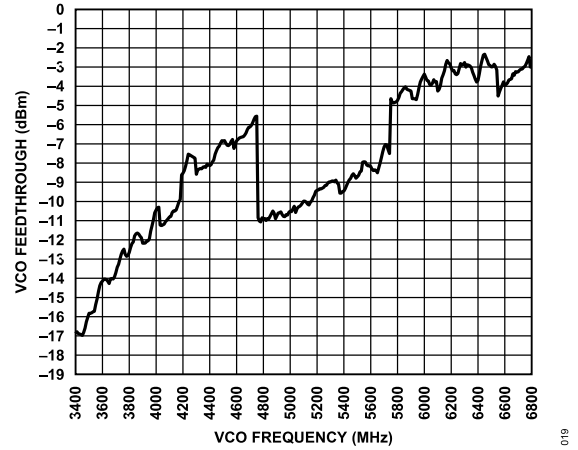

Figure 19. VCO Feedthrough at  $RF_{OUTB}$  (Board and Cable Losses De-Embedded) vs. VCO Frequency

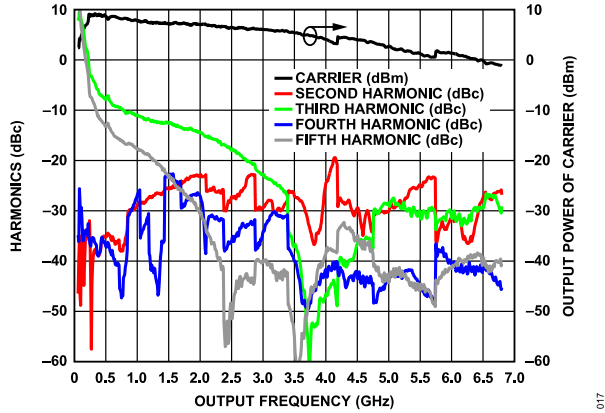

Figure 17. Harmonics and  $RF_{OUTA+}/RF_{OUTA-}$  Output Power of Carrier vs. Output Frequency (7.4 nH Inductors, 10 pF AC Coupling Capacitors, Board and Cable Losses De-Embedded)

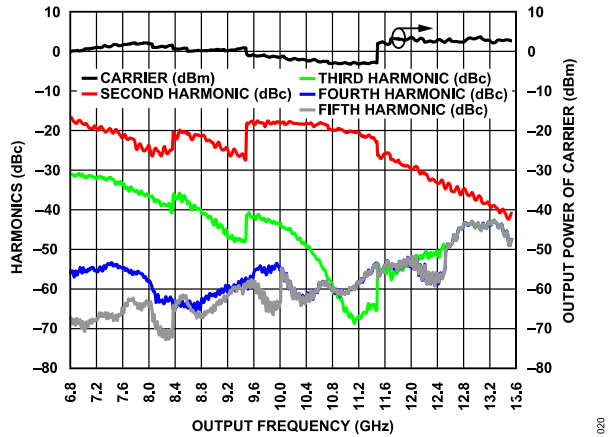

Figure 20. Harmonics and  $RF_{OUTB}$  Output Power of Carrier vs. Output Frequency (10 pF AC Coupling Capacitors, Board and Cable Losses De-Embedded)

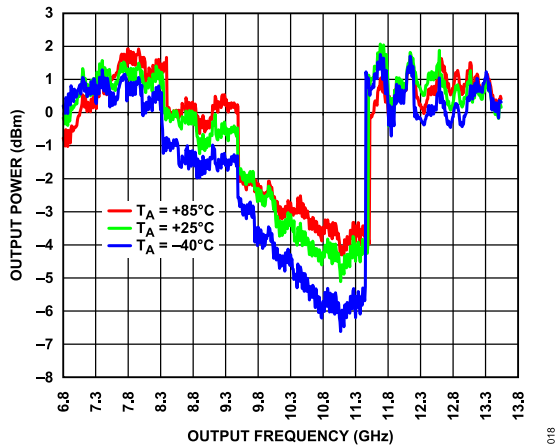

Figure 18.  $RF_{OUTB}$  Output Power vs. Output Frequency (10 pF AC Coupling Capacitors, Board and Cable Losses De-Embedded)

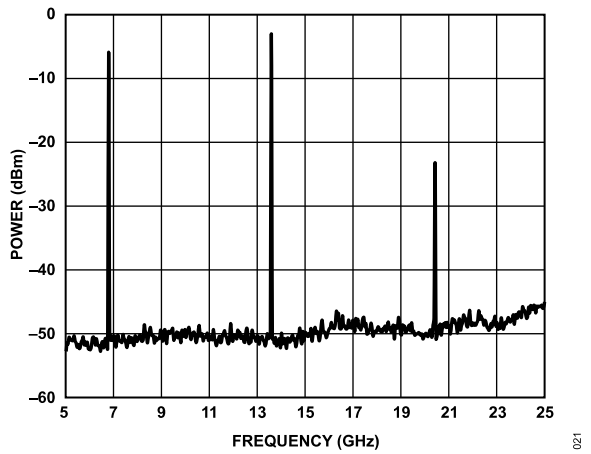

Figure 21. Wideband Spectrum,  $RF_{OUTB}$ , VCO = 6.8 GHz,  $RF_{OUTB}$  Enabled,  $RF_{OUTA+}/RF_{OUTA-}$  Disabled (Board Measurement)

TYPICAL PERFORMANCE CHARACTERISTICS

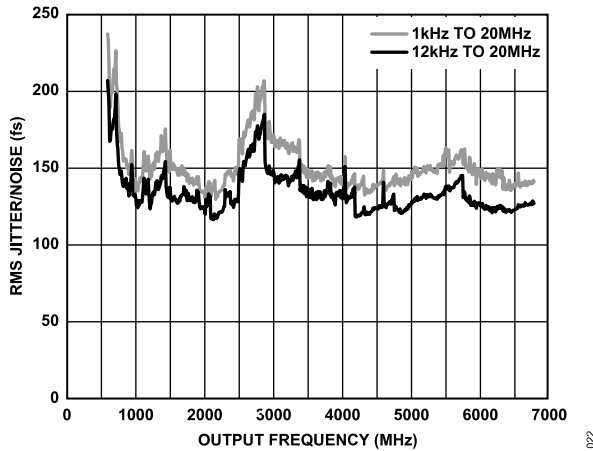

Figure 22. RMS Jitter/Noise vs. Output Frequency, PFD Frequency = 61.44 MHz, Loop Filter = 40 kHz

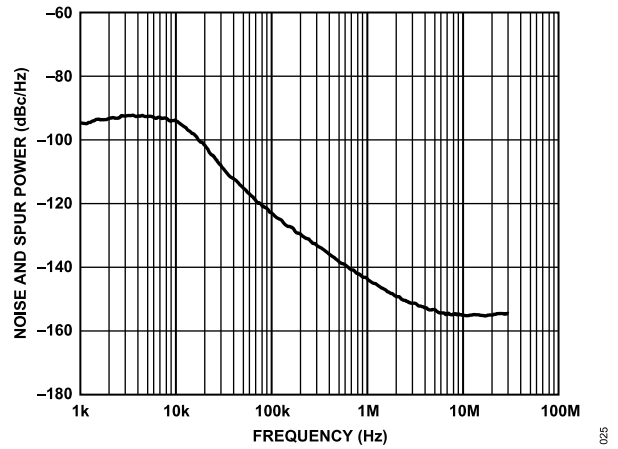

Figure 25. Fractional-N Spur Performance, GSM1800 Band,  $RF_{OUTA+} = 1550.2$  MHz,  $f_{REFIN} = 122.88$  MHz,  $f_{PFD} = 61.44$  MHz, Output Divide by 4 Selected, Loop Filter Bandwidth = 10 kHz, Channel Spacing = 20 kHz

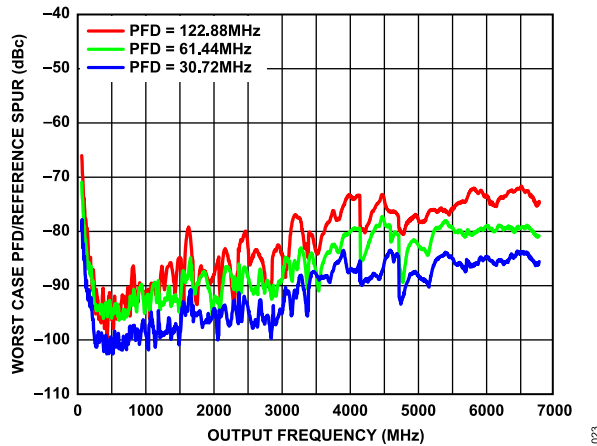

Figure 23. Worst Case PFD/Reference Spur vs. Output Frequency ( $RF_{OUTA+}/RF_{OUTA-}$ ),  $f_{PFD} = 30.72$  MHz, 61.44 MHz, and 122.88 MHz, Loop Filter = 3 kHz

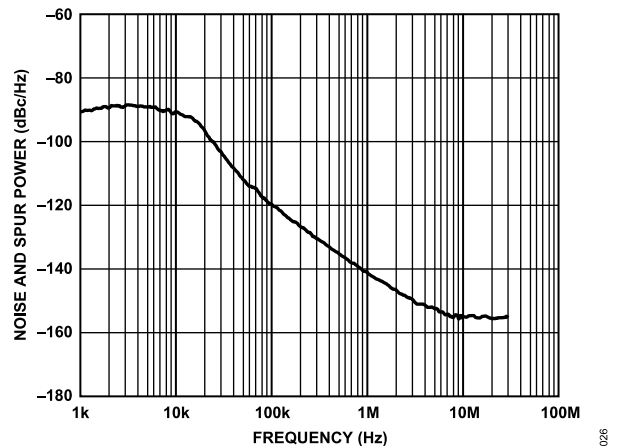

Figure 26. Fractional-N Spur Performance, W-CDMA Band,  $RF_{OUTA+} = 2113.5$  MHz,  $f_{REFIN} = 122.88$  MHz,  $f_{PFD} = 61.44$  MHz, Output Divide by 2 Selected, Loop Filter Bandwidth = 10 kHz, Channel Spacing = 20 kHz

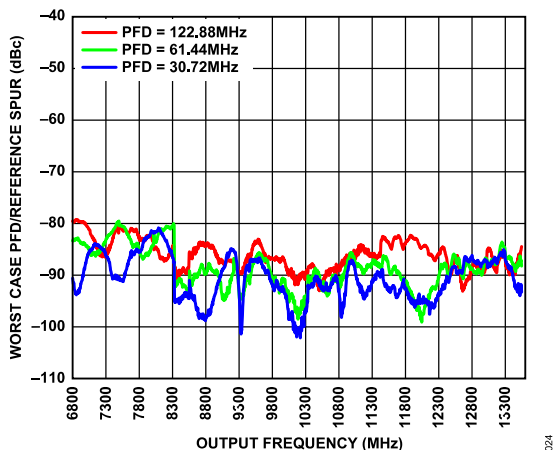

Figure 24. Worst Case PFD/Reference Spur vs. Output Frequency ( $RF_{OUTB}$ ),  $f_{PFD} = 30.72$  MHz, 61.44 MHz, and 122.88 MHz, Loop Filter = 3 kHz

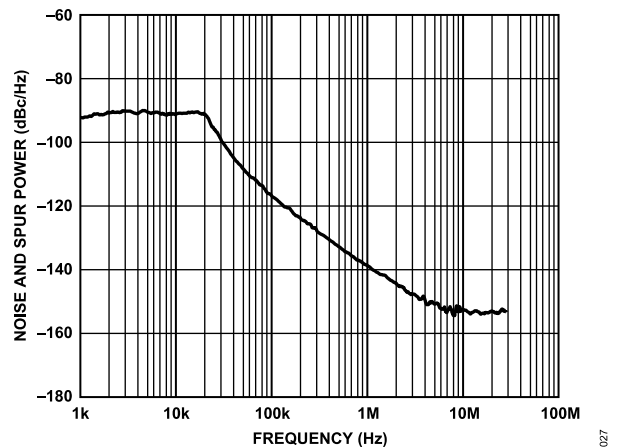

Figure 27. Fractional-N Spur Performance,  $RF_{OUTA+} = 2.591$  GHz,  $f_{REFIN} = 122.88$  MHz,  $f_{PFD} = 61.44$  MHz, Output Divide by 2 Selected, Loop Filter Bandwidth = 10 kHz, Channel Spacing = 20 kHz

## TYPICAL PERFORMANCE CHARACTERISTICS

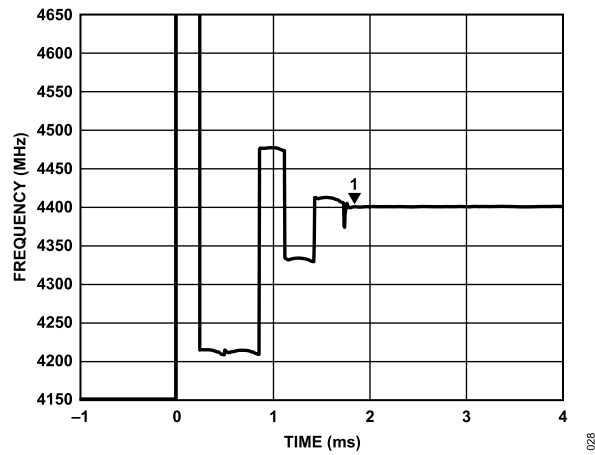

Figure 28. Lock Time for 250 MHz Jump from 4150 MHz to 4400 MHz, Loop Bandwidth = 23 kHz

## THEORY OF OPERATION

## REFERENCE INPUT SECTION

Figure 29 shows the reference input stage. The reference input can accept both single-ended and differential signals. Use the reference mode bit (Register 4, Bit DB9) to select the signal. To use a differential signal on the reference input, program this bit high. In this case, SW1 and SW2 are open, SW3 and SW4 are closed, and the current source that drives the differential pair of transistors switches on. The differential signal buffers and provides an emitter coupled logic (ECL) to the CMOS converter. When a single-ended signal is used as the reference, program Bit DB9 in Register 4 to 0. Connect the single-ended reference signal to REF<sub>IN</sub>A. In this case, SW1 and SW2 are closed, SW3 and SW4 are open, and the current source that drives the differential pair of transistors switches off.

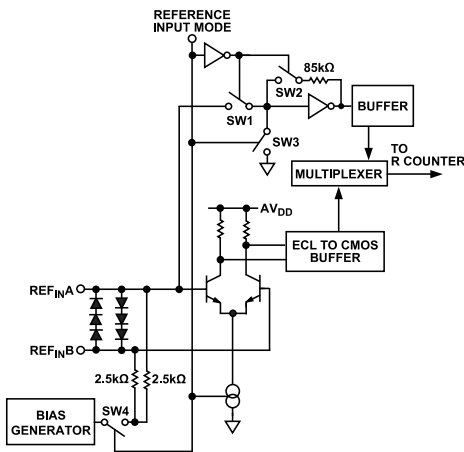

Figure 29. Reference Input Stage

## RF N DIVIDER

The RF N divider allows a division ratio in the PLL feedback path. Determine the division ratio by the INT, FRAC1, FRAC2, and MOD2 values that this divider comprises.

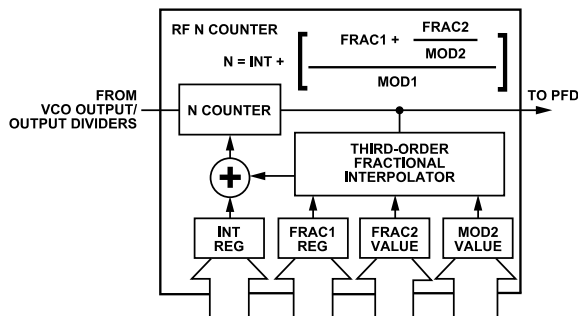

Figure 30. RF N Divider

INT, FRAC<sub>x</sub>, MOD<sub>x</sub>, and R Counter Relationship

The INT, FRAC1, FRAC2, MOD1, and MOD2 values, in conjunction with the R counter, make it possible to generate output frequencies

spaced by fractions of the PFD frequency ( $f_{PFD}$ ). For more information, see the [RF Synthesizer—A Worked Example](#) section.

Calculate the RF VCO frequency ( $VCO_{OUT}$ ) as follows:

$$VCO_{OUT} = f_{PFD} \times N \quad (1)$$

where:

$VCO_{OUT}$  is the output frequency of the VCO (without using the output divider).

$f_{PFD}$  is the frequency of the phase frequency detector.

$N$  is the desired value of the feedback counter,  $N$ .

Calculate  $f_{PFD}$  as follows:

$$f_{PFD} = f_{REFIN} \times ((1 + D)/(R \times (1 + T))) \quad (2)$$

where:

$f_{REFIN}$  is the reference input frequency.

$D$  is the  $f_{REFIN}$  doubler bit.

$R$  is the preset divide ratio of the binary 10-bit programmable reference counter (1 to 1023).

$T$  is the  $f_{REFIN}$  divide by 2 bit (0 or 1).

$N$  comprises

$$N = INT + \frac{FRAC1 + \frac{FRAC2}{MOD2}}{MOD1} \quad (3)$$

where:

$INT$  is the 16-bit integer value (23 to 32,767 for the 4/5 prescaler, and 75 to 65,535 for the 8/9 prescaler).

$FRAC1$  is the numerator of the primary modulus (0 to 16,777,215).  $FRAC2$  is the numerator of the 28-bit auxiliary modulus (0 to 268,435,455).

$MOD2$  is the programmable, 28-bit auxiliary fractional modulus (2 to 268,435,455).

$MOD1$  is a 24-bit primary modulus with a fixed value of  $2^{24} = 16,777,216$ .

Equation 3 results in a very fine frequency resolution with no residual frequency error. To apply this formula, take the following steps:

1. Calculate  $N$  by dividing  $VCO_{OUT}/f_{PFD}$ . The integer value of this number forms  $INT$ .
2. Subtract the  $INT$  value from the full  $N$  value.
3. Multiply the remainder by  $2^{24}$ . The integer value of this number forms  $FRAC1$ .
4. Calculate  $MOD2$  based on the channel spacing ( $f_{CHSP}$ ) as follows:

$$MOD2 = f_{PFD} / GCD(f_{PFD}, f_{CHSP}) \quad (4)$$

where:

$GCD(f_{PFD}, f_{CHSP})$  is the greatest common divisor of the PFD frequency and the desired channel spacing frequency.

$f_{CHSP}$  is the desired channel spacing frequency.

5. Calculate  $FRAC2$  as follows:

**THEORY OF OPERATION**

$$FRAC2 = ((N - INT) \times (2^{24} - FRAC1)) \times MOD2 \tag{5}$$

The FRAC2 and MOD2 fraction results in outputs with zero frequency error for channel spacings when

$$f_{PFD}/GCD(f_{PFD}/f_{CHSP}) < 268,435,455 \tag{6}$$

where:

- $f_{PFD}$  is the frequency of the phase frequency detector.
- GCD is a greatest common denominator function.
- $f_{CHSP}$  is the desired channel spacing frequency.

If zero frequency error is not required, the MOD1 and MOD2 denominators operate together to create a 52-bit resolution modulus.

**Integer N Mode**

When FRAC1 and FRAC2 are 0, the synthesizer operates in integer N mode.

**R Counter**

The 10-bit R counter allows the input reference frequency ( $f_{REFIN}$ ) to be divided down to produce the reference clock to the PFD. Division ratios from 1 to 1023 are allowed.

**PHASE FREQUENCY DETECTOR (PFD) AND CHARGE PUMP**

The PFD takes inputs from the R counter and N counter and produces an output proportional to the phase and frequency difference between them. Figure 31 is a simplified schematic of the phase frequency detector. The PFD includes a fixed delay element that sets the width of the antibacklash pulse. This pulse ensures that there is no dead zone in the PFD transfer function and provides a consistent reference spur level. Set the phase detector polarity to positive on this device because of the positive tuning of the VCO.

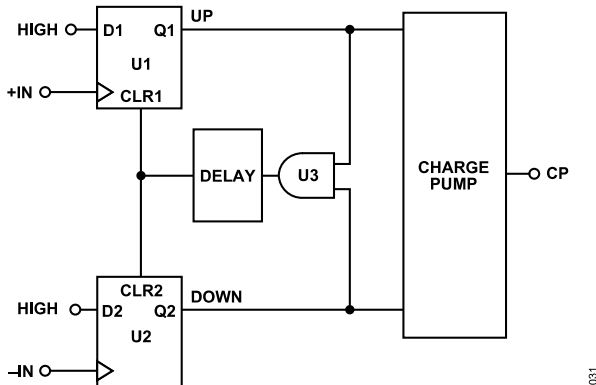

Figure 31. PFD Simplified Schematic

**MUXOUT AND LOCK DETECT**

The output multiplexer on the ADF5356 allows the user to access various internal points on the chip. The M3, M2, and M1 bits in

Register 4 control the state of MUXOUT. Figure 32 shows the MUXOUT section in block diagram form.

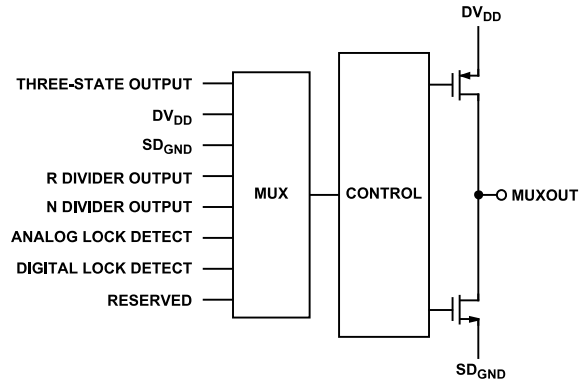

Figure 32. MUXOUT Schematic

**INPUT SHIFT REGISTERS**

The ADF5356 digital section includes a 10-bit R counter, a 16-bit RF integer N counter, a 24-bit FRAC1 counter, a 28-bit auxiliary fractional counter, and a 28-bit auxiliary modulus counter. Data clocks into the 32-bit shift register on each rising edge of CLK. The data clocks in MSB first. Data transfers from the shift register to one of 13 latches on the rising edge of LE. The state of the four control bits (C4, C3, C2, and C1) in the shift register determines the destination latch. As shown in Figure 2, the four least significant bits (LSBs) are DB3, DB2, DB1, and DB0. The truth table for these bits is shown in Table 6. Figure 36 and Figure 37 summarize the programming of the latches.

Table 6. Truth Table for the C4, C3, C2, and C1 Control Bits

Control Bits				Register
C4	C3	C2	C1	
0	0	0	0	Register 0
0	0	0	1	Register 1
0	0	1	0	Register 2
0	0	1	1	Register 3
0	1	0	0	Register 4
0	1	0	1	Register 5
0	1	1	0	Register 6
0	1	1	1	Register 7
1	0	0	0	Register 8
1	0	0	1	Register 9
1	0	1	0	Register 10
1	0	1	1	Register 11
1	1	0	0	Register 12
1	1	0	1	Register 13



## THEORY OF OPERATION

## PROGRAM MODES

Table 6 and Figure 38 through Figure 51 show how the program modes must be set up for the ADF5356.

The following settings in the ADF5356 are double-buffered: main fractional value (FRAC1), auxiliary modulus value (MOD2), auxiliary fractional value (FRAC2), reference doubler, reference divide by 2 (RDIV2), R counter value, and charge pump current setting. Two events must occur before the ADF5356 uses a new value for any of the double-buffered settings. First, the new value must latch into the device by writing to the appropriate register, and second, a new write to Register 0 must be performed.

For example, to ensure that the modulus value loads correctly, every time that the modulus value updates, Register 0 must be written to. The RF divider select in Register 6 is also double buffered, but only if DB14 of Register 4 is high.

## VCO

The VCO core in the ADF5356 consists of four separate VCOs, each of which uses 256 overlapping bands, which allows the device to cover a wide frequency range without large VCO sensitivity ( $K_V$ ) and without resulting in poor phase noise and spurious performance.

The correct VCO and band are chosen automatically by the VCO and band select logic when Register 0 is updated and autocalibration is enabled.

The R counter output is the clock for the band select logic. After band selection, normal PLL action resumes. The nominal value of  $K_V$  is 25 MHz/V when the N divider is driven from the VCO output, or the  $K_V$  value is divided by D. D is the output divider value if the N divider is driven from the RF output divider (chosen by programming Bits[DB23:DB21] in Register 6).

The VCO shows variations of  $K_V$  as the tuning voltage,  $V_{TUNE}$ , varies within the band and from band to band. For wideband applications covering a wide frequency range (and changing output dividers), a value of 25 MHz/V provides the most accurate  $K_V$ , because this value is closest to the average value. Figure 33 shows how  $K_V$  varies with the fundamental VCO frequency along with an average value for the frequency band. Users may prefer this  $K_V$  value shown in Figure 33 when using narrow-band designs.

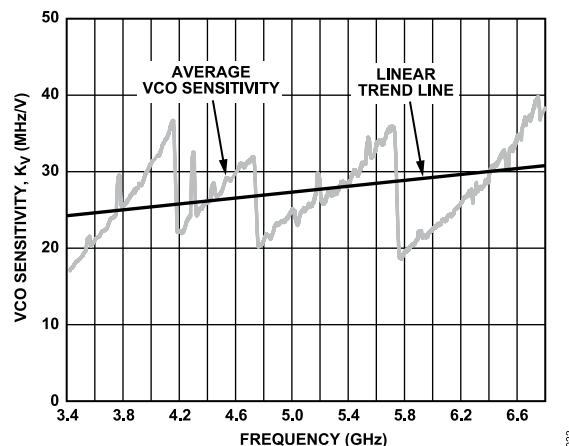

Figure 33. VCO Sensitivity,  $K_V$  vs. Frequency

## OUTPUT STAGE

The  $RF_{OUTA+}$  and  $RF_{OUTA-}$  pins of the ADF5356 connect to the collectors of a negative/positive/negative (NPN) differential pair driven by buffered outputs of the VCO, as shown in Figure 34. In this scheme, the ADF5356 contains internal 50  $\Omega$  resistors connected to the  $V_{RF}$  pin. To optimize the power dissipation vs. the output power requirements, the tail current of the differential pair is programmable using Bits[DB5:DB4] in Register 6. Four current levels can be set. These levels give approximate output power levels of -4 dBm, -1 dBm, +2 dBm, and +5 dBm, respectively. Levels of -4 dBm, -1 dBm, and +2 dBm can be achieved using a 50  $\Omega$  resistor connected to  $V_{RF}$  and ac coupling into a 50  $\Omega$  load. For accurate power levels, refer to the Typical Performance Characteristics section. An output power of 5 dBm requires an external shunt inductor to provide higher power levels; however, this addition results in less wideband performance using the internal bias only. Terminate the unused complementary output with a similar circuit to the used output.

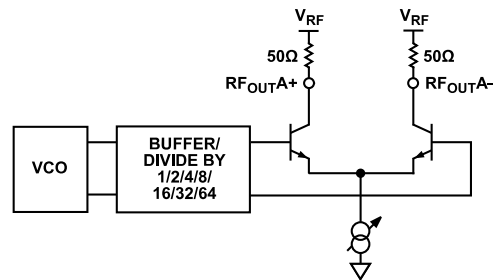

Figure 34. Output Stage

The doubled VCO output (6.8 GHz to 13.6 GHz) is available on the  $RF_{OUTB}$  pin, which can be ac-coupled to the next circuit.

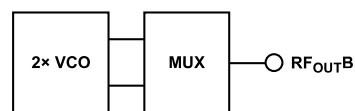

Figure 35. Output Stage

## THEORY OF OPERATION

Another feature of the ADF5356 is that the supply current to the RF<sub>OUTA+</sub>/RF<sub>OUTA-</sub> output stage can shut down until the ADF5356 achieves lock as measured by the digital lock detect circuitry. The

mute till lock detect (MTLD) bit (Bit DB11) in Register 6 enables this function.

RF<sub>OUTB</sub> directly connects to the VCO, and it can be muted but only by using the RF Output B enable bit (Bit DB10) in Register 6.

**Table 7. Total I<sub>DD</sub> (RF Output A Enabled)**

Supply <sup>1</sup>	RF <sub>OUTA±</sub> <sup>2</sup> Off (mA)	RF <sub>OUTA±</sub> = -4 dBm (mA)	RF <sub>OUTA±</sub> = -1 dBm (mA)	RF <sub>OUTA±</sub> = +2 dBm (mA)	RF <sub>OUTA±</sub> = +5 dBm (mA)
5 V Supply (I <sub>VCO</sub> and I <sub>CP</sub> )	74	74	74	74	74
3.3 V Supply (A <sub>DD</sub> , D <sub>DD</sub> , and I <sub>RFOUTx±</sub> )					
Divide by 1	82.6	103.9	115.1	126.1	136.9
Divide by 2	91.9	112.6	123.5	134.3	144.5
Divide by 4	101.7	122.6	134.0	145.2	156.0
Divide by 8	109.7	130.6	142.1	153.5	164.8
Divide by 16	114.7	135.7	147.3	158.6	169.8
Divide by 32	118.7	139.7	151.4	162.7	174.1
Divide by 64	121.1	142.1	153.8	165.2	176.4

<sup>1</sup> I<sub>DD</sub> is the total current of I<sub>VCO</sub>, I<sub>CP</sub>, A<sub>DD</sub>, D<sub>DD</sub>, and I<sub>RFOUTx±</sub>.

<sup>2</sup> RF<sub>OUTA±</sub> refers to RF<sub>OUTA+</sub>/RF<sub>OUTA-</sub>.

REGISTER MAPS

REGISTER 0																																	
RESERVED																				AUTOCAL	PRESALER	16-BIT INTEGER VALUE (INT)										CONTROL BITS	
DB31	DB30	DB29	DB28	DB27	DB26	DB25	DB24	DB23	DB22	DB21	DB20	DB19	DB18	DB17	DB16	DB15	DB14	DB13	DB12	DB11	DB10	DB9	DB8	DB7	DB6	DB5	DB4	DB3	DB2	DB1	DB0		
0	0	0	0	0	0	0	0	0	0	AC1	PR1	N16	N15	N14	N13	N12	N11	N10	N9	N8	N7	N6	N5	N4	N3	N2	N1	C4(0)	C3(0)	C2(0)	C1(0)		

REGISTER 1																															
RESERVED				24-BIT MAIN FRACTIONAL VALUE (FRAC1)																DBR <sup>1</sup>				CONTROL BITS							
DB31	DB30	DB29	DB28	DB27	DB26	DB25	DB24	DB23	DB22	DB21	DB20	DB19	DB18	DB17	DB16	DB15	DB14	DB13	DB12	DB11	DB10	DB9	DB8	DB7	DB6	DB5	DB4	DB3	DB2	DB1	DB0
0	0	0	0	F24	F23	F22	F21	F20	F19	F18	F17	F16	F15	F14	F13	F12	F11	F10	F9	F8	F7	F6	F5	F4	F3	F2	F1	C4(0)	C3(0)	C2(0)	C1(1)

REGISTER 2																															
14-BIT AUXILIARY FRACTIONAL LSB VALUE (FRAC2_LSB) DBR <sup>1</sup>														14-BIT AUXILIARY MODULUS MSB VALUE (MOD2_LSB) DBR <sup>1</sup>														CONTROL BITS			
DB31	DB30	DB29	DB28	DB27	DB26	DB25	DB24	DB23	DB22	DB21	DB20	DB19	DB18	DB17	DB16	DB15	DB14	DB13	DB12	DB11	DB10	DB9	DB8	DB7	DB6	DB5	DB4	DB3	DB2	DB1	DB0
F14	F13	F12	F11	F10	F9	F8	F7	F6	F5	F4	F3	F2	F1	M14	M13	M12	M11	M10	M9	M8	M7	M6	M5	M4	M3	M2	M1	C4(0)	C3(0)	C2(1)	C1(0)

REGISTER 3																															
RESERVED	SD LOAD RESET	PHASE RESYNC	PHASE ADJUST	24-BIT PHASE VALUE (PHASE)																DBR <sup>1</sup>				CONTROL BITS							
DB31	DB30	DB29	DB28	DB27	DB26	DB25	DB24	DB23	DB22	DB21	DB20	DB19	DB18	DB17	DB16	DB15	DB14	DB13	DB12	DB11	DB10	DB9	DB8	DB7	DB6	DB5	DB4	DB3	DB2	DB1	DB0
0	SD1	PR1	PA1	P24	P23	P22	P21	P20	P19	P18	P17	P16	P15	P14	P13	P12	P11	P10	P9	P8	P7	P6	P5	P4	P3	P2	P1	C4(0)	C3(0)	C2(1)	C1(1)

REGISTER 4																															
RESERVED			MUXOUT		REFERENCE DOUBLER DBR <sup>1</sup>	RDN/2 DBR <sup>1</sup>	10-BIT R COUNTER										DBR <sup>1</sup>	DOUBLE BUFF	CURRENT SETTING				DBR <sup>1</sup>	REF MODE	MUX LOGIC	PD POLARITY	POWER-DOWN	SOFTWARE STATE	COUNTER RESET	CONTROL BITS	
DB31	DB30	DB29	DB28	DB27	DB26	DB25	DB24	DB23	DB22	DB21	DB20	DB19	DB18	DB17	DB16	DB15	DB14	DB13	DB12	DB11	DB10	DB9	DB8	DB7	DB6	DB5	DB4	DB3	DB2	DB1	DB0
0	0	M3	M2	M1	RD2	RD1	R10	R9	R8	R7	R6	R5	R4	R3	R2	R1	D1	CP4	CP3	CP2	CP1	U6	U5	U4	U3	U2	U1	C4(0)	C3(1)	C2(0)	C1(0)

REGISTER 5																																
RESERVED																												CONTROL BITS				
DB31	DB30	DB29	DB28	DB27	DB26	DB25	DB24	DB23	DB22	DB21	DB20	DB19	DB18	DB17	DB16	DB15	DB14	DB13	DB12	DB11	DB10	DB9	DB8	DB7	DB6	DB5	DB4	DB3	DB2	DB1	DB0	
0	0	0	0	0	0	0	0	0	1	0	0	0	0	0	0	0	0	0	0	0	0	0	0	0	0	0	1	0	C4(0)	C3(1)	C2(0)	C1(1)

REGISTER 6																																
BLEED POLARITY	GATED BLEED	NEGATIVE BLEED	RESERVED				FEEDBACK SELECT	RF DIVIDER SELECT <sup>1</sup>	CHARGE PUMP BLEED CURRENT										RESERVED	MTLD	RF OUTPUT B ENABLE	RESERVED				RF OUTPUT A ENABLE	RF OUTPUT A POWER	CONTROL BITS				
DB31	DB30	DB29	DB28	DB27	DB26	DB25	DB24	DB23	DB22	DB21	DB20	DB19	DB18	DB17	DB16	DB15	DB14	DB13	DB12	DB11	DB10	DB9	DB8	DB7	DB6	DB5	DB4	DB3	DB2	DB1	DB0	
BP1	BL10	BL9	1	0	1	0	D9	D8	D7	D6	BL8	BL7	BL6	BL5	BL4	BL3	BL2	BL1	0	D5	D4	0	0	0	0	D3	D2	D1	C4(0)	C3(1)	C2(1)	C1(0)

<sup>1</sup>DBR = DOUBLE BUFFERED REGISTER—BUFFERED BY A WRITE TO REGISTER 0.  
<sup>2</sup>DBB = DOUBLE BUFFERED BITS—BUFFERED BY A WRITE TO REGISTER 0 WHEN BIT DB14 OF REGISTER 4 IS HIGH.

Figure 36. Register Summary (Register 0 to Register 6)

REGISTER MAPS

REGISTER 7

RESERVED																LE SEL SYNC EDGE		RESERVED		LE SYNC		RESERVED																LD CYCLE COUNT		LOL MODE		FRAC N LD PRECISION		LD MODE		CONTROL BITS			
DB31	DB30	DB29	DB28	DB27	DB26	DB25	DB24	DB23	DB22	DB21	DB20	DB19	DB18	DB17	DB16	DB15	DB14	DB13	DB12	DB11	DB10	DB9	DB8	DB7	DB6	DB5	DB4	DB3	DB2	DB1	DB0																		
0	0	0	0	0	LE2	1	LE1	0	0	0	0	0	0	0	0	0	0	0	0	0	0	0	LD5	LD4	LOL	LD3	LD2	LD1	C4(0)	C3(1)	C2(1)	C1(1)																	

REGISTER 8

RESERVED																																CONTROL BITS			
DB31	DB30	DB29	DB28	DB27	DB26	DB25	DB24	DB23	DB22	DB21	DB20	DB19	DB18	DB17	DB16	DB15	DB14	DB13	DB12	DB11	DB10	DB9	DB8	DB7	DB6	DB5	DB4	DB3	DB2	DB1	DB0				
0	0	0	1	0	1	0	1	0	1	0	1	1	0	0	1	0	1	1	0	0	1	0	1	0	1	1	0	C4(1)	C3(0)	C2(0)	C1(0)				

REGISTER 9

VCO BAND DIVISION								TIMEOUT								AUTOMATIC LEVEL CALIBRATION TIMEOUT				SYNTHESIZER LOCK TIMEOUT				CONTROL BITS							
DB31	DB30	DB29	DB28	DB27	DB26	DB25	DB24	DB23	DB22	DB21	DB20	DB19	DB18	DB17	DB16	DB15	DB14	DB13	DB12	DB11	DB10	DB9	DB8	DB7	DB6	DB5	DB4	DB3	DB2	DB1	DB0
VC8	VC7	VC6	VC5	VC4	VC3	VC2	VC1	TL10	TL9	TL8	TL7	TL6	TL5	TL4	TL3	TL2	TL1	AL5	AL4	AL3	AL2	AL1	SL5	SL4	SL3	SL2	SL1	C4(1)	C3(0)	C2(0)	C1(1)

REGISTER 10

RESERVED																ADC CLOCK DIVIDER								ADC CONVERSION		ADC ENABLE		CONTROL BITS			
DB31	DB30	DB29	DB28	DB27	DB26	DB25	DB24	DB23	DB22	DB21	DB20	DB19	DB18	DB17	DB16	DB15	DB14	DB13	DB12	DB11	DB10	DB9	DB8	DB7	DB6	DB5	DB4	DB3	DB2	DB1	DB0
0	0	0	0	0	0	0	0	1	1	0	0	0	0	0	0	0	0	AD8	AD7	AD6	AD5	AD4	AD3	AD2	AD1	AE2	AE1	C4(1)	C3(0)	C2(1)	C1(0)

REGISTER 11

RESERVED								VCO BAND HOLD		RESERVED																CONTROL BITS					
DB31	DB30	DB29	DB28	DB27	DB26	DB25	DB24	DB23	DB22	DB21	DB20	DB19	DB18	DB17	DB16	DB15	DB14	DB13	DB12	DB11	DB10	DB9	DB8	DB7	DB6	DB5	DB4	DB3	DB2	DB1	DB0
0	0	0	0	0	0	0	VH	0	1	1	0	0	0	0	1	0	0	1	0	0	0	0	0	0	0	0	0	C4(1)	C3(0)	C2(1)	C1(1)

REGISTER 12

PHASE RESYNC CLOCK VALUE																RESERVED																CONTROL BITS			
DB31	DB30	DB29	DB28	DB27	DB26	DB25	DB24	DB23	DB22	DB21	DB20	DB19	DB18	DB17	DB16	DB15	DB14	DB13	DB12	DB11	DB10	DB9	DB8	DB7	DB6	DB5	DB4	DB3	DB2	DB1	DB0				
P20	P19	P18	P17	P16	P15	P14	P13	P12	P11	P10	P9	P8	P7	P6	P5	P4	P3	P2	P1	0	1	0	1	1	1	1	1	C4(1)	C3(1)	C2(0)	C1(0)				

REGISTER 13

14-BIT AUXILIARY FRACTIONAL MSB VALUE (FRAC2_MSB) DBR <sup>1</sup>														14-BIT AUXILIARY MODULUS MSB VALUE (MOD2_MSB) DBR <sup>1</sup>														CONTROL BITS			
DB31	DB30	DB29	DB28	DB27	DB26	DB25	DB24	DB23	DB22	DB21	DB20	DB19	DB18	DB17	DB16	DB15	DB14	DB13	DB12	DB11	DB10	DB9	DB8	DB7	DB6	DB5	DB4	DB3	DB2	DB1	DB0
F14	F13	F12	F11	F10	F9	F8	F7	F6	F5	F4	F3	F2	F1	M14	M13	M12	M11	M10	M9	M8	M7	M6	M5	M4	M3	M2	M1	C4(1)	C3(1)	C2(0)	C1(1)

<sup>1</sup>DBR = DOUBLE BUFFERED REGISTER—BUFFERED BY A WRITE TO REGISTER 0.

037

Figure 37. Register Summary (Register 7 to Register 13)

REGISTER MAPS

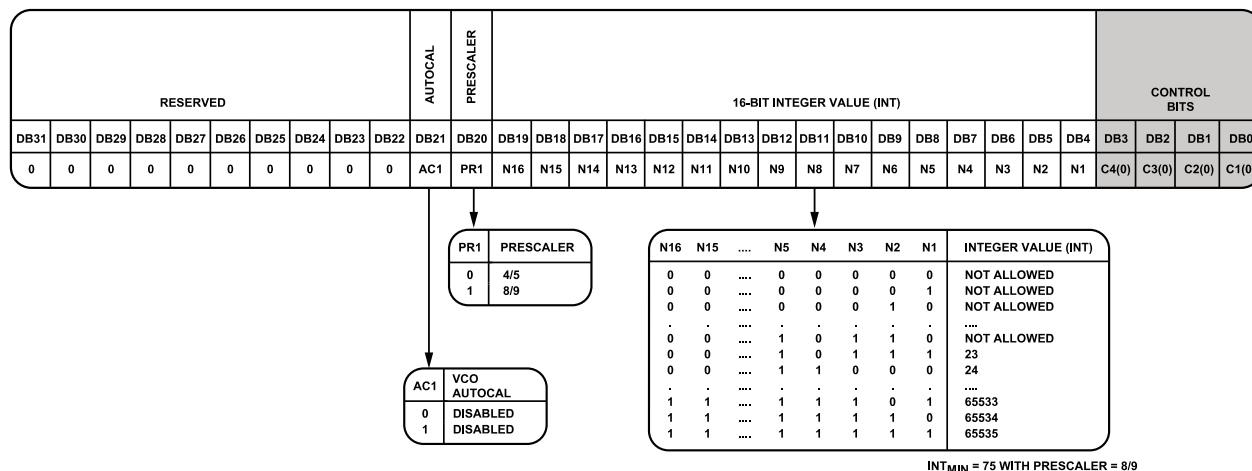

Figure 38. Register 0 Details

REGISTER 0

Control Bits

With C4 to C1 (Bits[DB3:DB0]) set to 0000, Register 0 is programmed. Figure 38 shows the input data format for programming this register.

Reserved

Bits[DB31:DB22] are reserved and must be set to 0.

Automatic Calibration (AUTOCAL)

Write to Register 0 to enact (by default) the VCO automatic calibration, and to choose the appropriate VCO and VCO subband. Write 1 to the AC1 bit (Bit DB21) to enable the automatic calibration, which is the recommended mode of operation.

Set the AC1 bit (Bit DB21) to 0 to disable the automatic calibration, which leaves the ADF5356 in the same band it is in when Register 0 updates.

Disable the automatic calibration only for fixed frequency applications, phase adjust applications, or very small (<10 kHz) frequency jumps.

Toggleing AUTOCAL is also required when changing frequency. See the Frequency Update Sequence section for more information.

Prescaler Value

The dual modulus prescaler (P/(P + 1)), together with the INT, FRACx, and MODx counters, determines the overall division ratio from the VCO output to the PFD input. The PR1 bit (Bit DB20) in Register 0 sets the prescaler value.

Operating at CML levels, the prescaler takes the clock from the VCO output and divides it down for the counters. It is based on a synchronous 4/5 core. When the prescaler is set to 4/5, the maximum RF frequency allowed is 6.0 GHz when T<sub>A</sub> ≥ 25°C and 5.7 GHz for all temperature ranges. Therefore, when generating the output frequencies above 6.0 GHz from RF output A, the prescaler must be set to 8/9. It is still possible to generate frequencies up to 13.6 GHz from RF output B with prescaler 4/5 by setting the feedback select bit (DB24) in Register 6 to divided and setting the output divider greater than 2.

The prescaler limits the INT value; therefore, if P is 4/5, N<sub>MIN</sub> is 23, and if P is 8/9, N<sub>MIN</sub> is 75.

16-Bit Integer Value

The 16 INT bits (Bits[DB19:DB4]) set the INT value, which determines the integer part of the feedback division factor. The INT value is used in Equation 3 (see the INT, FRACx, MODx, and R Counter Relationship section). All integer values from 23 to 32,767 are allowed for the 4/5 prescaler. For the 8/9 prescaler, the minimum integer value is 75, and the maximum value is 65,535.

REGISTER MAPS

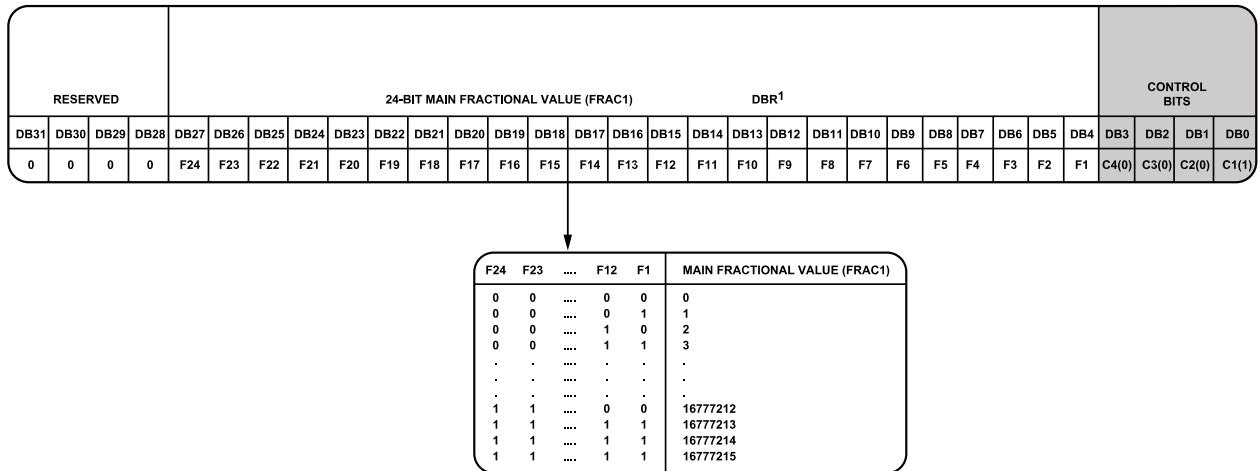

<sup>1</sup>DBR = DOUBLE BUFFERED REGISTER—BUFFERED BY A WRITE TO REGISTER 0.

Figure 39. Register 1 Details

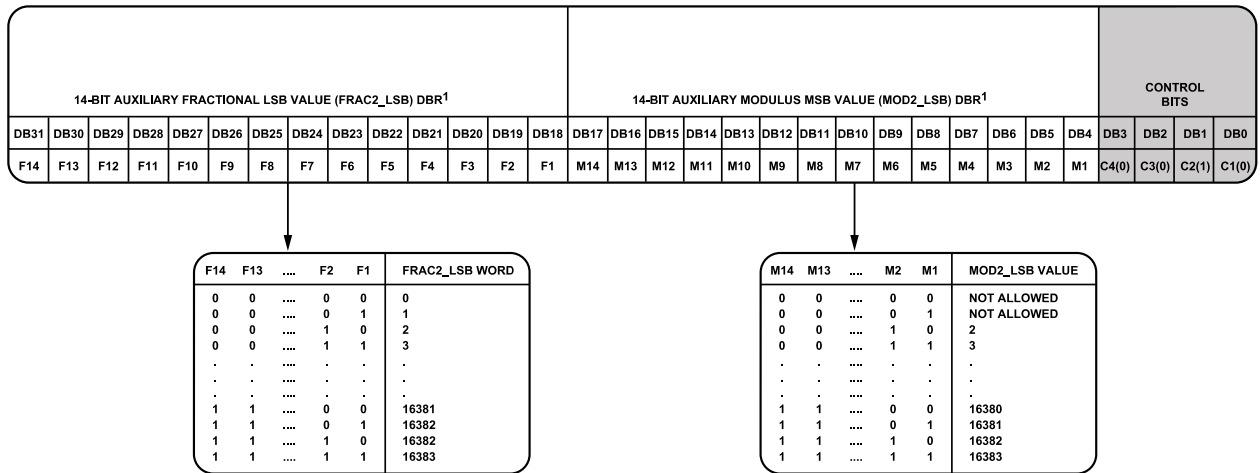

<sup>1</sup>DBR = DOUBLE BUFFERED REGISTER—BUFFERED BY A WRITE TO REGISTER 0.

Figure 40. Register 2 Details

REGISTER MAPS

REGISTER 1

Control Bits

With C4 to C1 (Bits[DB3:DB0]) set to 0001, Register 1 is programmed. Figure 39 shows the input data format for programming this register.

Reserved

Bits[DB31:DB28] are reserved and must be set to 0.

24-Bit Main Fractional Value

The 24 FRAC1 bits (Bits[DB27:DB4]) set the numerator of the fraction that is input to the Σ-Δ modulator. This fraction, together with the INT value, specifies the new frequency channel that the synthesizer locks to, as shown in the RF Synthesizer—A Worked Example section. FRAC1 values from 0 to (MOD1 - 1) cover channels over a frequency range equal to the PFD reference frequency.

14-Bit Auxiliary Fractional LSB Value (FRAC2\_LSB)

Use this value with the auxiliary fractional MSB value (Register 13, Bits[DB31:DB18]) to generate the total auxiliary fractional value.

$$FRAC2 = (FRAC2\_MSB \times 2^{14}) + FRAC2\_LSB \tag{7}$$

FRAC2 must be less than the MOD2 value programmed in Register 2 and Register 13.

14-Bit Auxiliary Modulus LSB Value (MOD2\_LSB)

Use this value with the auxiliary modulus MSB value (Register 13, Bits[DB17:DB4]) to generate the total auxiliary modulus value.

$$MOD2 = (MOD2\_MSB) \times 2^{14} + MOD2\_LSB \tag{8}$$

Use MOD2 to correct any residual error due to the main fractional modulus.

REGISTER 2

Control Bits

With C4 to C1 (Bits[DB3:DB0]) set to 0010, Register 2 is programmed. Figure 40 shows the input data format for programming this register.

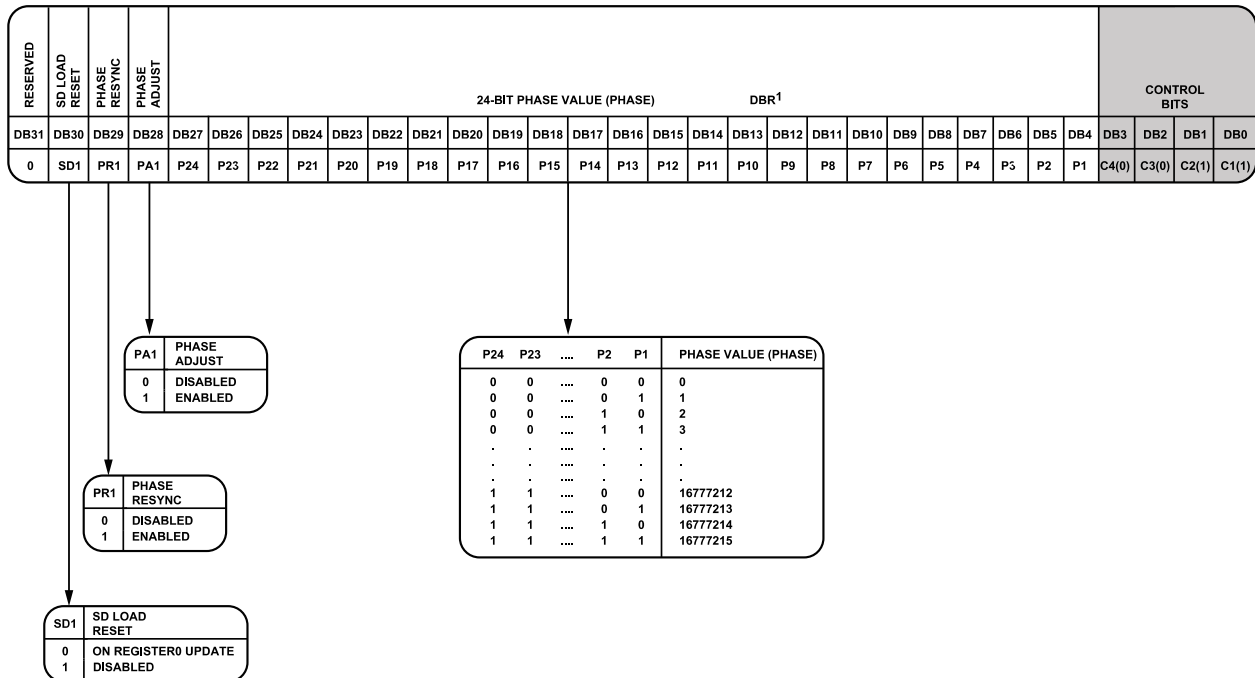

<sup>1</sup>DBR = DOUBLE BUFFERED REGISTER—BUFFERED BY A WRITE TO REGISTER 0.

Figure 41. Register 3

## REGISTER MAPS

### REGISTER 3

#### Control Bits

With C4 to C1 (Bits[DB3:DB0]) set to 0011, Register 3 is programmed. Figure 41 shows the input data format for programming this register.

#### Reserved

Bit DB31 is reserved and must be set to 0.

#### SD Load Reset

When writing to Register 0, the  $\Sigma$ - $\Delta$  modulator resets. For applications in which the phase is continually adjusted, this reset may not be desirable; therefore, in these cases, disable the  $\Sigma$ - $\Delta$  reset by writing a 1 to the SD1 bit (Bit DB30).

#### Phase Resynchronization

To use the phase resynchronization feature, the PR1 bit (Bit DB29) must be set to 1. If unused, the bit can be programmed to 0. The phase resynchronization clock value must also be used in Register 12 to ensure that the resynchronization feature is applied after the PLL settles to the final frequency. If the PLL has not settled to the final frequency, phase resynchronization may not function correctly. Resynchronization is useful in phased array and beamforming applications. It ensures repeatability of the output phase when programming the same frequency. In phase critical applications that use frequencies requiring the output divider (<3400 MHz), it is necessary to feed the N divider with the divided VCO frequency as distinct from the fundamental VCO frequency, which is achieved by programming the D9 bit (Bit DB24) in Register 6 to 0, which ensures divided feedback to the N divider.

For resynchronization applications, enable the  $\Sigma$ - $\Delta$  modulator load reset (SD load reset) in Register 3 by setting the SD1 bit (Bit DB30) to 0.

The phase of the RF output frequency can be adjusted in 24-bit steps from 0° (0) to 360° ( $2^{24} - 1$ ) relative to the resynchronization phase. For phase adjustment applications, the phase is set by P24 to P1 (Bits[DB27:DB1]).

$$(\text{Phase Value}/16,777,216) \times 360^\circ \quad (9)$$

Practically, this setting means that repeatable adjustable phase values can be achieved by using the resynchronization feature with different phase values.

#### Phase Adjustment

To adjust the relative output phase of the ADF5356 on each Register 0 update, set the PA1 bit (Bit DB28) to 1. This feature differs from the resynchronization feature in that it is useful when adjustments to phase are made continually in an application. For this function, disable the VCO automatic calibration by setting the AC1 bit (Bit DB21) in Register 0 to 1, and disable the  $\Sigma$ - $\Delta$  load reset by setting the SD1 bit (Bit DB30) in Register 3 to 1.

#### 24-Bit Phase Value

The phase of the RF output frequency can adjust in 24-bit steps, from 0° (0) to 360° ( $2^{24} - 1$ ). For phase adjust applications, the phase is set by

$$(\text{Phase Value}/16,777,216) \times 360^\circ \quad (10)$$

When the phase value is programmed to Register 3, each subsequent adjustment of Register 0 increments the phase by the value in this equation.



REGISTER MAPS

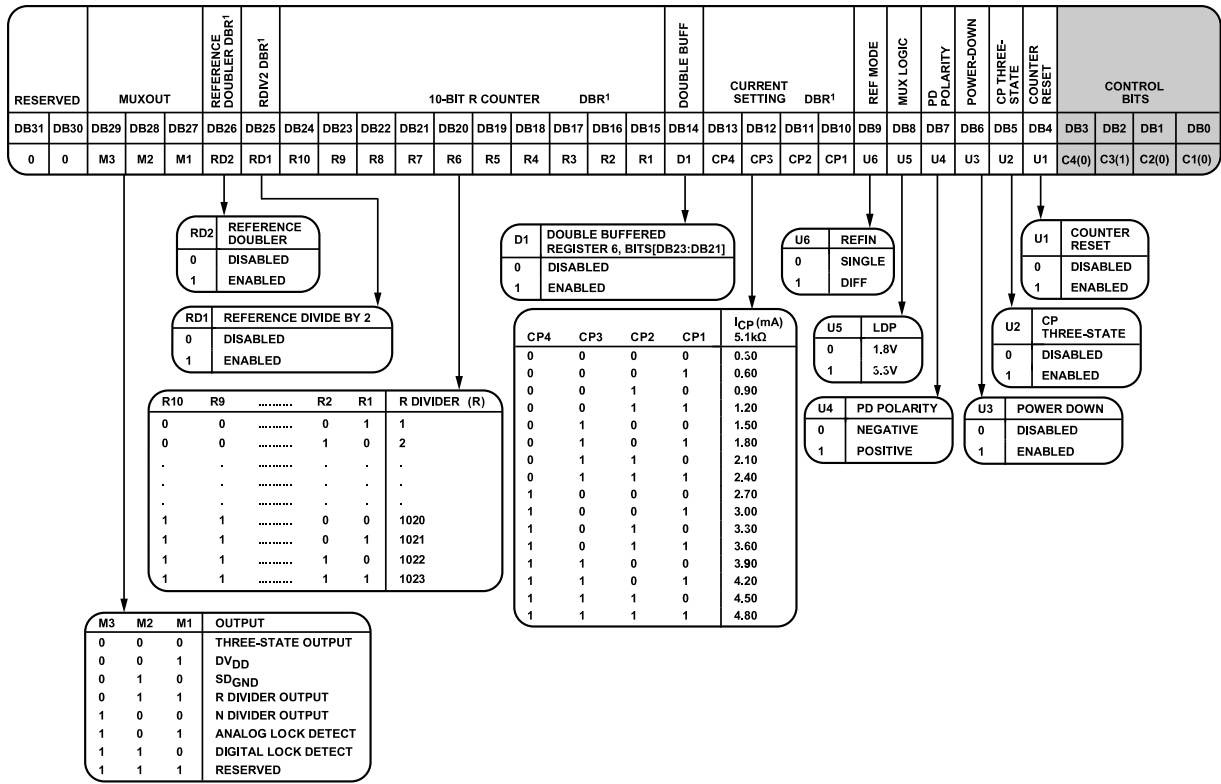

<sup>1</sup>DBR = DOUBLE BUFFERED REGISTER—BUFFERED BY A WRITE TO REGISTER 0.

26

Figure 42. Register 4 Details

## REGISTER MAPS

### REGISTER 4

#### Control Bits

With C4 to C1 (Bits[DB3:DB0]) set to 0100, Register 4 is programmed. [Figure 42](#) shows the input data format for programming this register.

#### Reserved

Bits[DB31:DB30] are reserved and must be set to 0.

#### MUXOUT

The on-chip multiplexer (MUXOUT) is controlled by Bits[DB29:DB27]. For additional details, see [Figure 42](#).

When changing the frequency, that is, writing Register 0, MUXOUT must not be set to the N divider output or R divider output. If needed, enable these functions after locking to the new frequency.

#### Reference Doubler

Setting the RD2 bit (Bit DB26) to 0 feeds the reference frequency signal directly to the 10-bit R counter, disabling the doubler. Setting this bit to 1 multiplies the reference frequency by a factor of 2 before feeding it into the 10-bit R counter. When the doubler is disabled, the  $f_{REFIN}$  falling edge is the active edge at the PFD input to the fractional synthesizer. When the doubler is enabled, both the rising and falling edges of the reference frequency become active edges at the PFD input.

The maximum allowable reference frequency when the doubler is enabled is 80 MHz.

#### RDIV2

Setting the RD1 bit (Bit DB25) to 1 inserts a divide by 2, toggle flip flop between the R counter and PFD, which extends the maximum reference frequency input rate. This function provides a 50% duty cycle signal at the PFD input.

#### 10-Bit R Counter

The 10-bit R counter divides the reference frequency input,  $f_{REFIN}$ , to produce the reference clock to the PFD. Division ratios range from 1 to 1023.

#### Double Buffer

The D1 bit (Bit DB14) enables or disables double buffering of the RF divider select bits (Bits[DB23:DB21]) in Register 6. The [Program Modes](#) section explains how double buffering works.

#### Charge Pump Current Setting

The CP4 to CP1 bits (Bits[DB13:DB10]) set the charge pump current. Set this value to the charge pump current that the loop filter

is designed with (see [Figure 42](#)). For the lowest spurs, the 0.90 mA setting is recommended.

#### Reference Mode

The ADF5356 permits use of either differential or single-ended reference sources.

For optimum integer boundary spur performance, it is recommended to use the single-ended setting for all references up to 250 MHz (even if using a differential reference signal). Use the differential setting for reference frequencies above 250 MHz.

#### Mux Logic

To assist with logic compatibility, MUXOUT is programmable to two logic levels. Set the U5 bit (Bit DB8) to 0 to select 1.8 V logic, and set it to 1 to select 3.3 V logic.

#### Phase Detector Polarity

The U4 bit (Bit DB7) sets the phase detector polarity. When a passive loop filter or a noninverting active loop filter is used, set DB7 to 1 (positive). If an active filter with an inverting characteristic is used, set this bit to 0 (negative).

REGISTER MAPS

Power-Down

The U3 bit (Bit DB6) sets the programmable power-down mode. Setting DB6 to 1 performs a power-down. Setting DB6 to 0 returns the synthesizer to normal operation. In software power-down mode, the ADF5356 retains all information in its registers. The register contents are lost only when the supply voltages are removed.

When power-down activates, the following events occur:

- ▶ The synthesizer counters are forced to their load state conditions.
- ▶ The VCO powers down.
- ▶ The charge pump is forced into three-state mode.
- ▶ The digital lock detect circuitry resets.
- ▶ The RF<sub>OUTA+</sub>/RF<sub>OUTA-</sub> and RF<sub>OUTB</sub> output stages are disabled.
- ▶ The input registers remain active and capable of loading and latching data.

Charge Pump Three-State

Setting the U2 bit (Bit DB5) to 1 puts the charge pump into three-state mode. Set DB5 to 0 for normal operation.

Counter Reset

The U1 bit (Bit DB4) resets the R counter, N counter, and VCO band select of the ADF5356. When DB4 is set to 1, the RF synthesizer N counter, R counter, and VCO band select are reset. For normal operation, set DB4 to 0.

REGISTER 5

The bits in Register 5 are reserved and must be programmed as described in Figure 43, using a hexadecimal word of 0x00800025.

RESERVED																								CONTROL BITS								
DB31	DB30	DB29	DB28	DB27	DB26	DB25	DB24	DB23	DB22	DB21	DB20	DB19	DB18	DB17	DB16	DB15	DB14	DB13	DB12	DB11	DB10	DB9	DB8	DB7	DB6	DB5	DB4	DB3	DB2	DB1	DB0	
0	0	0	0	0	0	0	0	1	0	0	0	0	0	0	0	0	0	0	0	0	0	0	0	0	0	0	1	0	C4(0)	C3(1)	C2(0)	C1(1)

Figure 43. Register 5 Details (0x00800025)

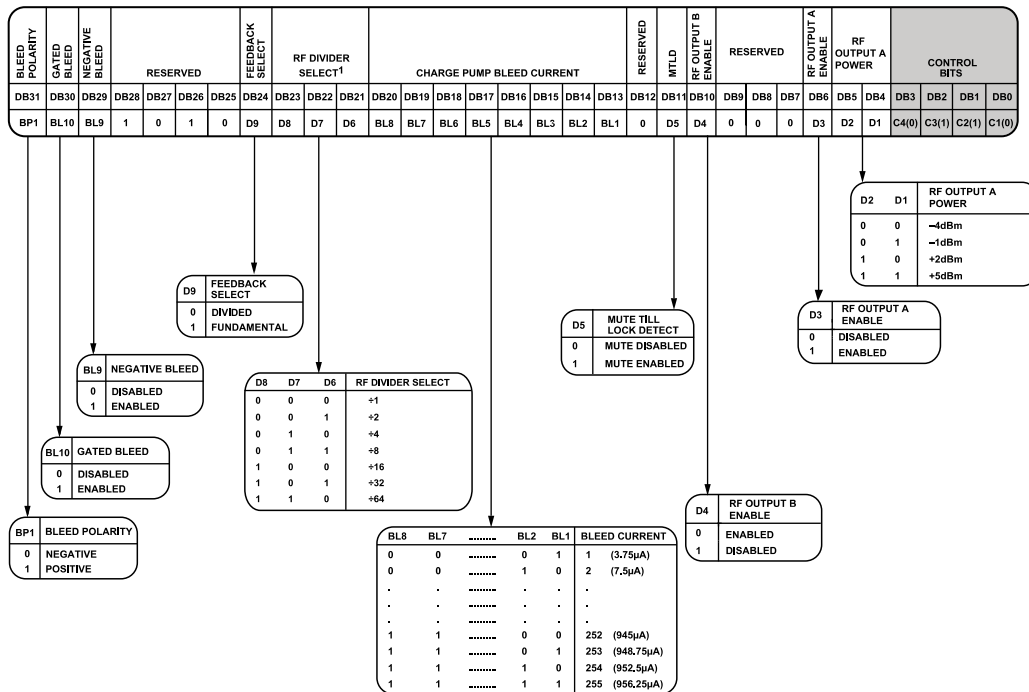

\*BITS[DB23:DB21] ARE BUFFERED BY A WRITE TO REGISTER 0 WHEN THE DOUBLE BUFFER BIT, BIT DB14 OF REGISTER 4, IS ENABLED.

Figure 44. Register 6 Details

## REGISTER MAPS

## REGISTER 6

## Control Bits

With C4 to C1 (Bits[DB3:DB0]) set to 0110, Register 6 is programmed. Figure 44 shows the input data format for programming this register.

## Bleed Polarity

BP1 (Bit DB31) sets the polarity of the charge pump bleed current.

## Gated Bleed

Bleed currents can be used for improving phase noise and spurs; however, due to a potential impact on lock time, the gated bleed bit, BL10 (Bit DB30), if set to 1, ensures bleed currents are not switched on until the digital lock detect asserts logic high. Note that this function requires the digital lock detect to be enabled in Register 4.

## Negative Bleed

Use of constant negative bleed is recommended for most fractional-N applications because it improves the linearity of the charge pump, leading to lower noise and spurious signals than leaving it off. To enable negative bleed, write 1 to BL9 (Bit DB29), and to disable negative bleed, write 0 to BL9.

Do not use negative bleed when operating in integer N mode, that is,  $FRAC1 = FRAC2 = 0$ . Do not use negative bleed for  $f_{PFD}$  values greater than 100 MHz.

## Reserved

Bits[DB28:DB25] are reserved and must be set to 1010. Bit DB12 is reserved and must be set to 0. Bits[DB9:DB7] are reserved and must be set to 0.

## Feedback Select

D9 (Bit DB24) selects the feedback from the output of the VCO to the N counter. When D9 is set to 1, the signal is taken directly from the VCO. When this bit is set to 0, the signal is taken from the output of the output dividers. The dividers enable coverage of the wide frequency band (53.125 MHz to 6800 MHz). When the divider is enabled and the feedback signal is taken from the output, the RF output signals of two separately configured PLLs are in phase.

Divided feedback is useful in some applications where the positive interference of signals is required to increase the power.

## RF Divider Select

D8 to D6 (Bits[DB23:DB21]) select the value of the RF output divider (see Figure 44).

## Charge Pump Bleed Current

BL8 to BL1 (Bits[DB20:DB13]) control the level of the bleed current added to the charge pump output. This current optimizes the phase noise and spurious levels from the device.

Calculate the optimal bleed setting using the following equation:

$$\text{Bleed Value} = \text{floor}(24 \times (f_{PFD}/61.44 \text{ MHz}) \times (I_{CP}/0.9 \text{ mA})) \quad (11)$$

where:

*Bleed Value* is the value programmed to Bits[DB20:DB13].

floor() is a function to round down to the nearest integer value.

$f_{PFD}$  is the PFD frequency.

$I_{CP}$  is the value of charge pump current setting, Bits[DB13:DB10] of Register 4.

If  $f_{PFD} > 100 \text{ MHz}$ , disable the bleed current using Bit DB29.

## Mute Till Lock Detect

When D5 (Bit DB11) is set to 1, the supply current to the RF output stage is shut down until the device achieves lock, as determined by the digital lock detect circuitry.

## RF Output B Enable

D4 (Bit DB10) enables or disables RF Output B (RF<sub>OUTB</sub>). If DB10 is set to 0, RF Output B is enabled. If DB10 is set to 1, RF Output B is disabled.

## RF Output A Enable

D3 (Bit DB6) enables or disables RF Output A (RF<sub>OUTA+</sub>/RF<sub>OUTA-</sub>). If DB3 is set to 0, RF Output A is disabled. If DB6 is set to 1, RF Output A is enabled.

## RF Output A Power

D2 and D1 (Bits[DB5:DB4]) set the value of the RF Output A (RF<sub>OUTA+</sub>/RF<sub>OUTA-</sub>) power level (see Figure 44).

REGISTER MAPS

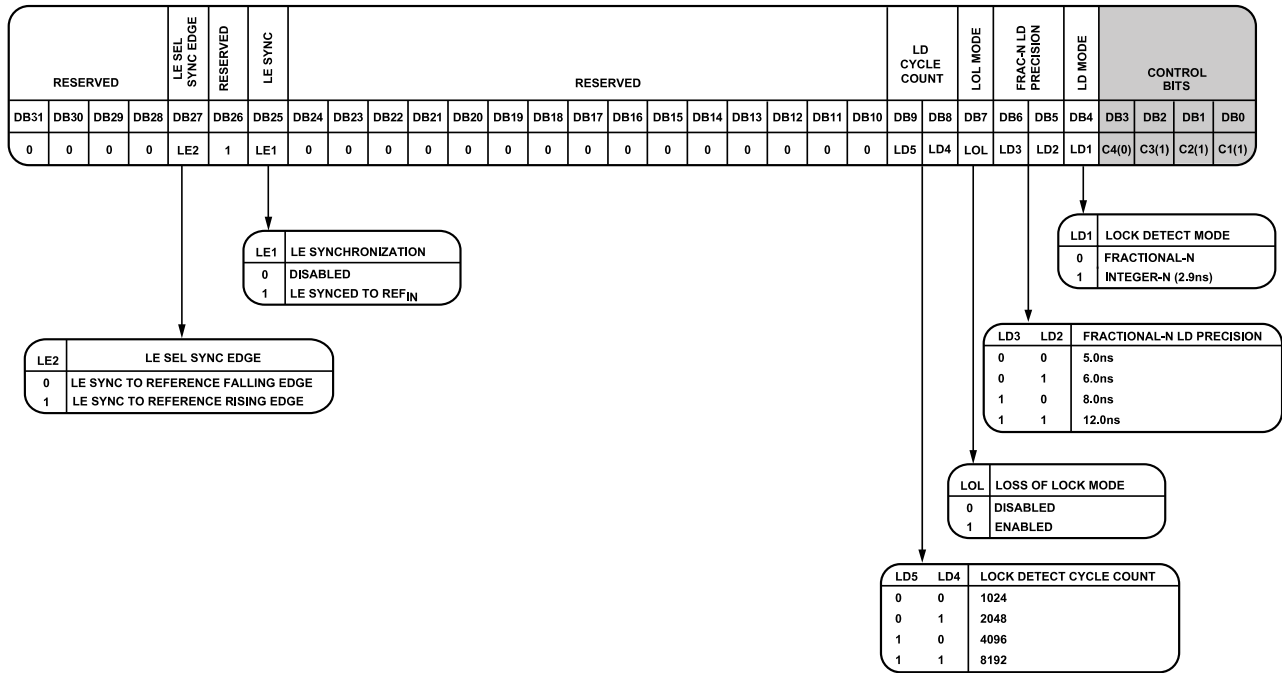

Figure 45. Register 7 Details

045

REGISTER MAPS

REGISTER 7

Control Bits

With C4 to C1 (Bits[DB3:DB0]) set to 0111, Register 7 is programmed. Figure 45 shows the input data format for programming this register.

Reserved

Bits[DB31:DB28] are reserved and must be set to 0. Bit DB26 is reserved and must be set to 1. Bits[DB24:DB10] are reserved and must be set to 0.

LE Select Synchronization Edge

LE2 (Bit DB27) allows selection of the synchronization load enable (LE) edge to the falling or rising edge of the reference clock, which is useful for applications that require synchronization to a common reference edge (see Figure 45). To use this bit, LE synchronization (Bit DB25) must be set to 1.

LE Synchronization

When set to 1, Bit DB25 ensures that the LE edge is synchronized internally with the rising edge of reference input frequency. This synchronization prevents the rare event of the reference and RF dividers loading at the same time as a falling edge of the reference frequency, which can lead to longer lock times.

Fractional-N Lock Detect (LD) Cycle Count

LD5 and LD4 (Bits[DB9:DB8]) set the number of consecutive cycles counted by the lock detect circuitry before asserting lock detect high (see Figure 45 for details).

Loss of Lock (LOL) Mode

Set the LOL mode bit (Bit DB7) to 1 when the application is a fixed frequency application in which the reference (REF<sub>IN</sub>) signal is likely to be removed, such as a clocking application. The standard lock detect circuit assumes that the REF<sub>IN</sub> signal is always present; however, this may not be the case with clocking applications. To enable this functionality, set Bit DB7 to 1.

Fractional-N Lock Detect (LD) Precision

LD3 and LD2 (Bits[DB6:DB5]) set the precision of the lock detect circuitry in fractional-N mode. LD precision is available at 5.0 ns, 6.0 ns, 8.0 ns, or 12.0 ns. If bleed currents are used, use 12.0 ns.

Lock Detect (LD) Mode

When LD1 (Bit DB4) is set to 0, lock detect precision is set by fractional-N lock detect precision as described in the Fractional-N Lock Detect (LD) Precision section. If LD1 (Bit DB4) is set to 1, lock detect precision is 2.9 ns long, which is more appropriate for integer N applications.

RESERVED																								CONTROL BITS							
DB31	DB30	DB29	DB28	DB27	DB26	DB25	DB24	DB23	DB22	DB21	DB20	DB19	DB18	DB17	DB16	DB15	DB14	DB13	DB12	DB11	DB10	DB9	DB8	DB7	DB6	DB5	DB4	DB3	DB2	DB1	DB0
0	0	0	1	0	1	0	1	0	1	0	1	1	0	0	1	0	1	1	0	0	1	0	1	0	1	1	0	C4(1)	C3(0)	C2(0)	C1(0)

Figure 46. Register 8 Details (0x15596568)

REGISTER MAPS

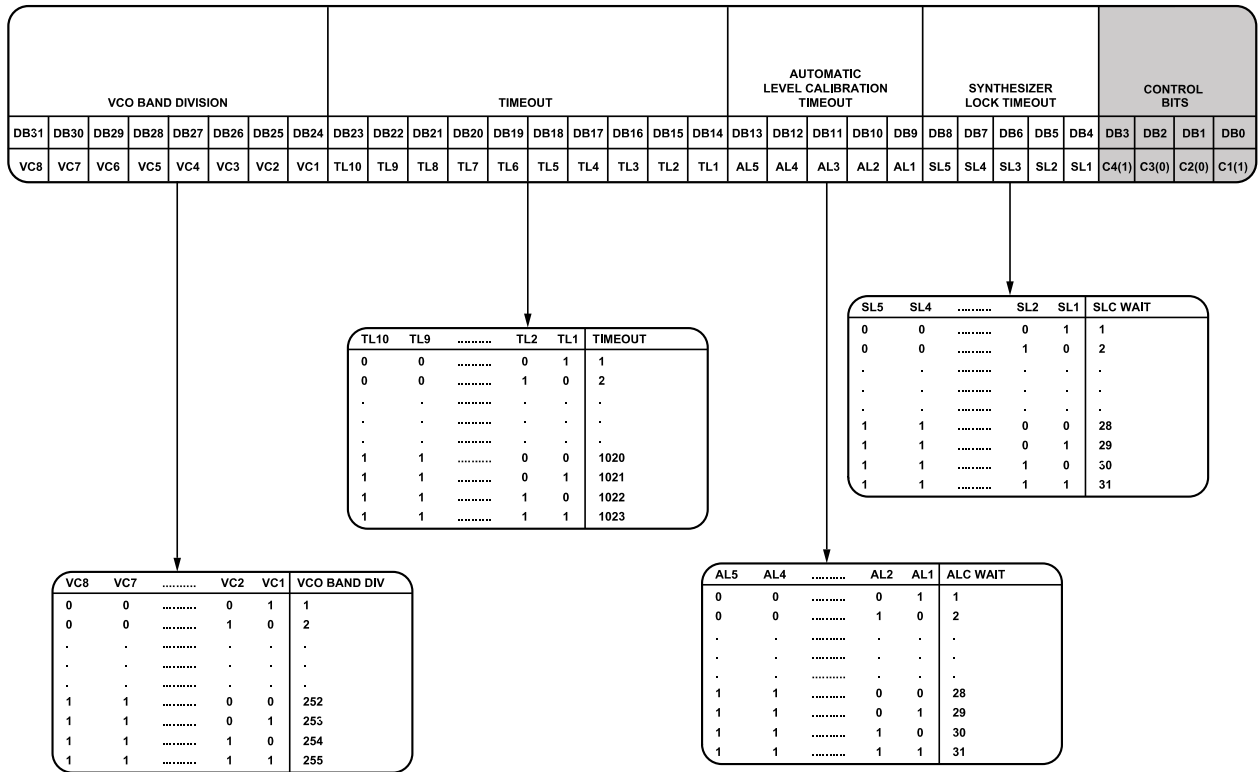

Figure 47. Register 9 Details

047

REGISTER MAPS

REGISTER 8

The bits in this register are reserved and must be programmed as shown in Figure 46, using a hexadecimal word of 0x15596568.

REGISTER 9

For a worked example and more information, see the PLL Lock Time section.

Control Bits

With C4 to C1 (Bits[DB3:DB0]) set to 1001, Register 9 is programmed. Figure 47 shows the input data format for programming this register.

VCO Band Division

VC8 to VC1 (Bits[DB31:DB24]) set the value of the VCO band division clock. Determine the value of this clock by

$$VCO \text{ Band Division} = \text{ceiling}(f_{PFD}/1,600,000) \tag{12}$$

where ceiling() is a function that rounds up to the nearest integer.

Timeout

TL10 to TL1 (Bits[DB23:DB14]) set the timeout value for the VCO band select.

Automatic Level Calibration (ALC) Timeout

AL5 to AL1 (Bits[DB13:DB9]) set the timer value used for the automatic level calibration of the VCO. This function combines the PFD frequency, the timeout variable, and the ALC wait variable. Choose the ALC such that the following equation is always greater than 50 μs:

$$ALC \text{ Wait} > (50 \mu s \times f_{PFD})/Timeout \tag{13}$$

Synthesizer Lock Timeout

SL5 to SL1 (Bits[DB8:DB4]) set the synthesizer lock timeout value. This value allows the V<sub>TUNE</sub> force to settle on the V<sub>TUNE</sub> pin. The value must be 20 μs. Calculate the value using the following equation:

$$Synthesizer \text{ Lock Timeout} > (20 \mu s \times f_{PFD})/Timeout \tag{14}$$

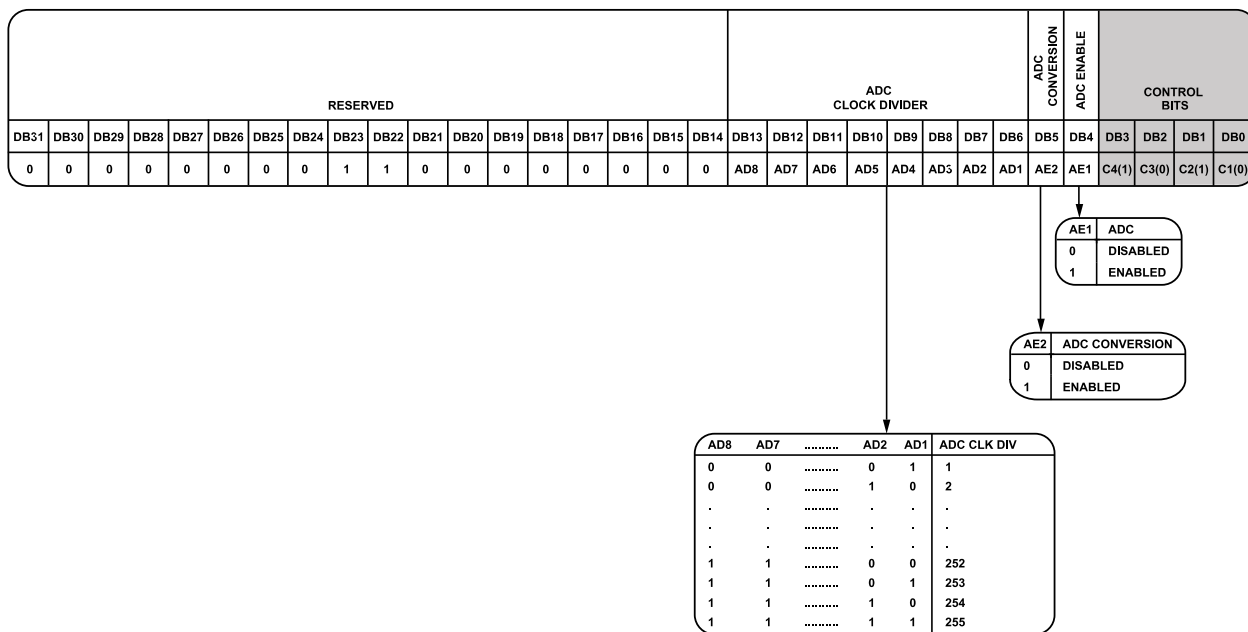

Figure 48. Register 10 Details



REGISTER MAPS

REGISTER 10

Control Bits

With C4 to C1 (Bits[DB3:DB0]) set to 1010, Register 10 is programmed. Figure 48 shows the input data format for programming this register.

Reserved

Bits[DB31:DB14] are reserved. Bits[DB23:DB22] must be set to 11, and all other bits in this range must be set to 0.

ADC Clock Divider (ADC\_CLK\_DIV)

An on-board analog-to-digital converter (ADC) determines the  $V_{TUNE}$  setpoint relative to the ambient temperature of the ADF5356 environment. The ADC ensures that the initial tuning voltage in any application is chosen correctly to avoid any temperature drift issues.

The ADC uses a clock that is equal to the output of the R counter (or the PFD frequency) divided by ADC\_CLK\_DIV.

AD8 to AD1 (Bits[DB13:DB6]) set the value of this divider. On power-up, the R counter is not programmed; however, in these power-up cases, it defaults to R = 1.

Choose the value such that

$$ADC\_CLK\_DIV = \text{ceiling}(((f_{PFD}/100,000) - 2)/4) \tag{15}$$

For example, for  $f_{PFD} = 61.44$  MHz, set ALC\_CLK\_DIV = 154 so that the ADC clock frequency is 99.417 kHz.

If ADC\_CLK\_DIV is greater than 255, set it to 255.

ADC Conversion Enable

AE2 (Bit DB5) ensures that the ADC performs a conversion when a write to Register 10 is performed. It is recommended to enable this mode.

ADC Enable

AE1 (Bit DB4), when set to 1, powers up the ADC for the temperature dependent  $V_{TUNE}$  calibration. It is recommended to always use this function.

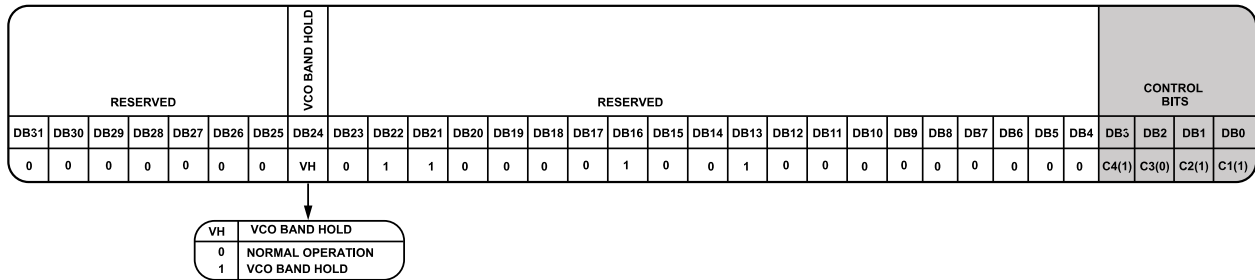

Figure 49. Register 11 Details

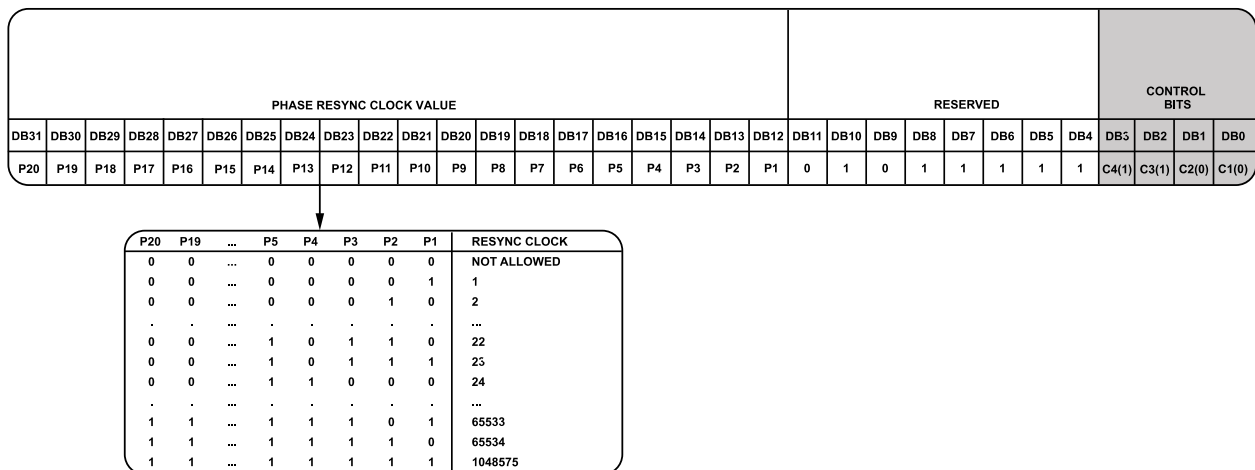

Figure 50. Register 12 Details

REGISTER MAPS

REGISTER 11

Control Bits

With C4 to C1 (Bits[DB3:DB0]) set to 1011, Register 11 is programmed. Figure 49 shows the input data format for programming this register.

Reserved

Bits[DB31:DB25] are reserved and must be set to 0. Bit DB22, Bit DB21, Bit DB16, and Bit DB13 must be set to 1, and all other bits in this range (Bits[DB23:DB4]) must be set to 0.

VCO Band Hold

VH (Bit DB24), when set to 1, prevents a reset of the VCO core, band, and bias during a counter reset. VCO band hold is required for applications that use external PLLs.

REGISTER 12

Control Bits

With C4 to C1 (Bits[DB3:DB0]) set to 1100, Register 12 is programmed. Figure 50 shows the input data format for programming this register.

Phase Resynchronization Clock Value

P20 to P1 (Bits[DB31:DB12]) set the timeout counter for activation of the phase resynchronization. This value must be set such that a resynchronization occurs immediately after (and not before) the PLL has achieved lock, after reprogramming.

Calculate the timeout value using the following equation:

$$\text{Timeout Value} = \text{Phase Resynchronization Clock Value} \times f_{\text{PFD}} \quad (16)$$

When not using phase resynchronization, set these bits to 1 for normal operation.

Reserved

Bits [DB11:DB4] are reserved. Bit DB11 and Bit DB9 must be set to 0, and all other bits in this range must be set to 1.

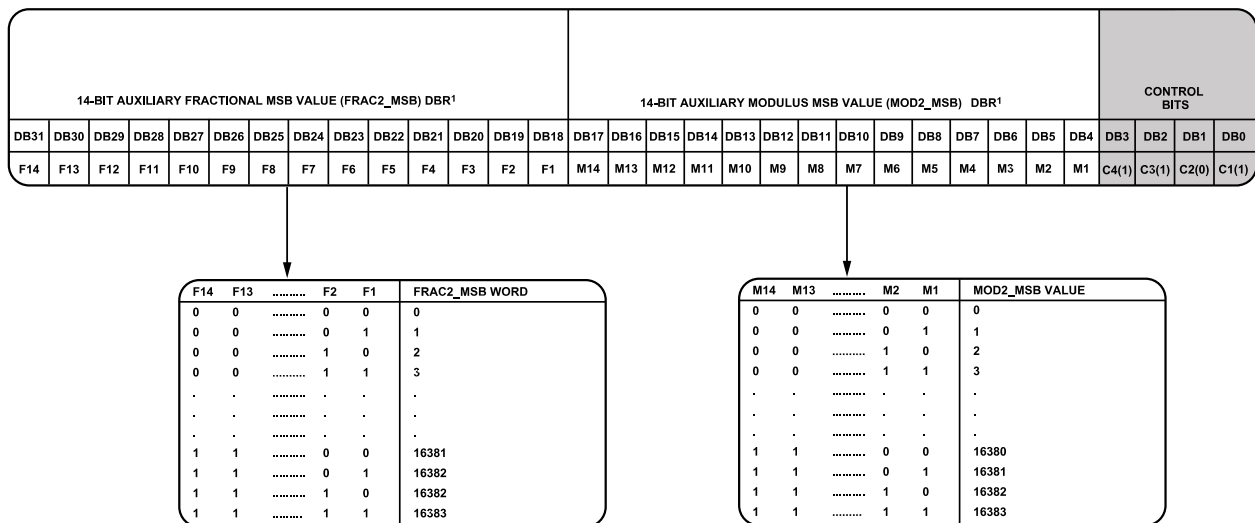

<sup>1</sup>DBR = DOUBLE BUFFERED REGISTER—BUFFERED BY A WRITE TO REGISTER 0.

Figure 51. Register 13 Details

## REGISTER MAPS

## REGISTER 13

## Control Bits

With C4 to C1 (Bits[DB3:DB0]) set to 1101, Register 13 is programmed. [Figure 51](#) shows the input data format for programming this register.

## 14-Bit Auxiliary Fractional MSB Value (FRAC2\_MSB)

This value is used with the auxiliary fractional LSB value (Register 2, Bits[DB31:DB18]) to generate the total auxiliary fractional FRAC2 value.

$$FRAC2 = (FRAC2\_MSB \times 2^{14}) + FRAC2\_LSB \quad (17)$$

These bits can be set to all zeros to ensure software compatibility with the [ADF5355](#).

## 14-Bit Auxiliary Modulus MSB Value (MOD2\_MSB)

This value is used with the auxiliary fractional MSB value (Register 2, Bits[DB17:DB4]) to generate the total auxiliary modulus MOD2 value.

$$MOD2 = (MOD2\_MSB \times 2^{14}) + MOD2\_LSB \quad (18)$$

## REGISTER INITIALIZATION SEQUENCE

At initial power-up, after the correct application of voltages to the supply pins, the ADF5356 registers must be programmed in sequence. For  $f \leq 75$  MHz, use the following sequence:

1. Register 13.
2. Register 12.
3. Register 11.
4. Register 10.
5. Register 9.
6. Register 8.
7. Register 7.
8. Register 6.
9. Register 5.
10. Register 4.
11. Register 3.
12. Register 2.
13. Register 1.
14. Ensure that >16 ADC clock cycles elapse between the write of Register 10 and Register 0. For example, if ADC clock = 99.417 kHz, wait  $16/99,417 \text{ sec} = 161 \mu\text{s}$ . See the [Register 10](#) section for more information.
15. Register 0.

For  $f_{\text{PFD}} > 75$  MHz (initially lock with halved  $f_{\text{PFD}}$ ), use the following sequence:

1. Register 13 (for halved  $f_{\text{PFD}}$ ).
2. Register 12.
3. Register 11.
4. Register 10.
5. Register 9.
6. Register 8.
7. Register 7.
8. Register 6 (bleed current setting using the desired  $f_{\text{PFD}}$ ).
9. Register 5.
10. Register 4 (with the R divider doubled to halve  $f_{\text{PFD}}$ ).
11. Register 3.
12. Register 2 (for halved  $f_{\text{PFD}}$ ).
13. Register 1 (for halved  $f_{\text{PFD}}$ ).
14. Ensure that >16 ADC clock cycles elapse between the write of Register 10 and Register 0. For example, if ADC clock = 99.417 kHz, wait  $16/99,417 \text{ sec} = 161 \mu\text{s}$ . See the [Register 10](#) section for more information.
15. Register 0 (for halved  $f_{\text{PFD}}$ ; autocalibration enabled).
16. Register 13 (for the desired  $f_{\text{PFD}}$ ).
17. Register 4 (with the R divider set for the desired  $f_{\text{PFD}}$ ).
18. Register 2 (for the desired  $f_{\text{PFD}}$ ).
19. Register 1 (for the desired  $f_{\text{PFD}}$ ).
20. Register 0 (for the desired  $f_{\text{PFD}}$ ; autocalibration disabled).

## FREQUENCY UPDATE SEQUENCE

Frequency updates require updating the auxiliary modulator (FRAC2/MOD2) in Register 2 and Register 13, the fractional value (FRAC1) in Register 1, and the integer value (INT) in Register 0. It is recommended to perform a temperature dependent  $V_{\text{TUNE}}$  calibration by updating Register 10 first. Therefore, for  $f_{\text{PFD}} \leq 75$  MHz, the sequence must be as follows:

1. Register 13.
2. Register 10.
3. Register 2.
4. Register 1.
5. Ensure that >16 ADC clock cycles elapse between the write of Register 10 and Register 0. For example, if ADC clock = 99.417 kHz, wait  $16/99,417 \text{ sec} = 161 \mu\text{s}$ . See the [Register 10](#) section for more information.
6. Register 0.

For  $f_{\text{PFD}} > 75$  MHz (initially lock with halved  $f_{\text{PFD}}$ ), the sequence must be as follows:

1. Register 13 (for halved  $f_{\text{PFD}}$ ).
2. Register 10.
3. Register 4 (with the R divider doubled to halve  $f_{\text{PFD}}$ ).
4. Register 2 (for halved  $f_{\text{PFD}}$ ).
5. Register 1 (for halved  $f_{\text{PFD}}$ ).
6. Ensure that >16 ADC clock cycles elapse between the write of Register 10 and Register 0. For example, if ADC clock = 99.417

## REGISTER MAPS

kHz, wait 16/99,417 sec = 161  $\mu$ s. See the [Register 10](#) section for more information.

7. Register 0 (for halved  $f_{PFD}$ ; autocalibration enabled).
8. Register 13 (for the desired  $f_{PFD}$ ).
9. Register 4 (with the R divider doubled to halve  $f_{PFD}$ )
10. Register 2 (for the desired  $f_{PFD}$ ).
11. Register 1 (for the desired  $f_{PFD}$ ).
12. Register 0 (for desired  $f_{PFD}$ ; autocalibration disabled).

The frequency change occurs on the write to Register 0.

## RF SYNTHESIZER—A WORKED EXAMPLE

Use the following equations to program the ADF5356 synthesizer:

$$f_{RFOUT} = \left( INT + \frac{FRAC1 + \frac{FRAC2}{MOD2}}{MOD1} \right) \times (f_{PFD}) / RF \text{ Divider} \quad (19)$$

where:

$f_{RFOUT}$  is the RF output frequency.

$INT$  is the integer division factor.

$FRAC1$  is the fractionality.

$FRAC2$  is the auxiliary fractionality ( $FRAC2 = (FRAC2\_MSB \times 2^{14}) + FRAC2\_LSB$ ).

$MOD2$  is the auxiliary modulus ( $MOD2 = (MOD2\_MSB \times 2^{14}) + MOD2\_LSB$ ).

$MOD1$  is the fixed 24-bit modulus.

$RF \text{ Divider}$  is the output divider that divides down the VCO frequency.

$$f_{PFD} = f_{REFIN} \times ((1 + D)/(R \times (1 + T))) \quad (20)$$

where:

$f_{REFIN}$  is the reference input frequency.

$D$  is the reference doubler bit.

$R$  is the  $f_{REFIN}$  reference division factor.

$T$  is the reference divide by 2 bit (0 or 1).

For example, in a universal mobile telecommunication system (UMTS) where a 2112.8 MHz RF output frequency ( $f_{RFOUT}$ ) is required, a 122.88 MHz reference frequency input ( $f_{REFIN}$ ) is available. Note that the ADF5356 VCO operates in the frequency range of 3400 MHz to 6800 MHz. Therefore, the RF divider of 2 must be used (VCO frequency = 4225.6 MHz,  $RF_{OUT} = \text{VCO frequency}/RF \text{ divider} = 4225.6 \text{ MHz}/2 = 2112.8 \text{ MHz}$ ).

The feedback path is also important. In this example, the VCO output is fed back before the output divider (see [Figure 52](#)). In this example, the 122.88 MHz reference signal is divided by 2 to generate an  $f_{PFD}$  of 61.44 MHz. The desired channel spacing is 200 kHz.

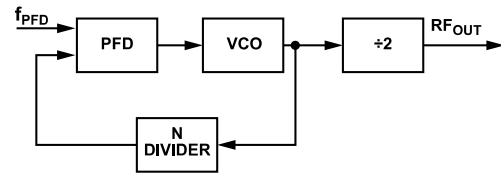

Figure 52. Loop Closed Before Output Divider

The worked example is as follows:

$$N = \text{VCO}_{OUT} / f_{PFD} = 4225.6 \text{ MHz} / 61.44 \text{ MHz} = 68.776041666666667 \quad (21)$$

$$INT = \text{int}(\text{VCO frequency} / f_{PFD}) = 68 \quad (22)$$

where  $\text{int}()$  is a function indicating the integer result.

$$FRAC = 0.776041666666667 \quad (23)$$

$$MOD1 = 16,777,216 \quad (24)$$

$$FRAC1 = \text{int}(MOD1 \times FRAC) = 13,019,818 \quad (25)$$

$$\text{Remainder} = 0.666666667 \text{ or } 2/3 \quad (26)$$

$$MOD2 = f_{PFD} / \text{GCD}(f_{PFD}, f_{CHSP}) = 61.44 \text{ MHz} / \text{GCD}(61.44 \text{ MHz}, 200 \text{ kHz}) = 1536 \quad (27)$$

$$FRAC2 = \text{Remainder} \times 1536 = 1024 \quad (28)$$

From [Equation 20](#),

$$f_{PFD} = (122.88 \text{ MHz} \times (1 + 0)/2) = 61.44 \text{ MHz} \quad (29)$$

$$2112.8 \text{ MHz} = 61.44 \text{ MHz} \times ((INT + (FRAC1 + FRAC2 / MOD2) / 2^{24}) / 2) \quad (30)$$

where:

$INT = 68$ .

$FRAC1 = 13,019,818$ .

$FRAC2 = 1024$ .

$MOD2 = 1536$ .

$RF \text{ Divider} = 2$ .

## REFERENCE DOUBLER AND REFERENCE DIVIDER

The on-chip reference doubler allows the input reference signal to be doubled. The doubler is useful for increasing the PFD comparison frequency. To improve the noise performance of the system, increase the PFD frequency. Doubling the PFD frequency typically improves noise performance by 3 dB.

The reference divide by 2 divides the reference signal by 2, resulting in a 50% duty cycle PFD frequency.

## SPURIOUS OPTIMIZATION AND FAST LOCK

Narrow loop bandwidths can filter unwanted spurious signals; however, these bandwidths typically have a long lock time. A wider loop bandwidth achieves faster lock times but may lead to increased spurious signals inside the loop bandwidth.

## REGISTER MAPS

### OPTIMIZING JITTER

For the lowest jitter applications, use the highest possible PFD frequency to minimize the contribution of in-band noise from the PLL. Set the PLL filter bandwidth such that the in-band noise of the PLL intersects with the open-loop noise of the VCO, minimizing the contribution of both to the overall noise.

Use the [ADIsimPLL](#) design tool for this task.

### SPUR MECHANISMS

This section describes the two different spur mechanisms that arise with a fractional-N synthesizer and methods to minimize them in the ADF5356.

#### Integer Boundary Spurs

One mechanism for fractional spur creation is the interactions between the RF VCO frequency and the reference frequency. When these frequencies are not integer related (the purpose of a fractional-N synthesizer), spur sidebands appear on the VCO output spectrum at an offset frequency that corresponds to the beat note or the difference in frequency between an integer multiple of the reference and the VCO frequency. These spurs are attenuated by the loop filter and are more noticeable on channels close to integer multiples of the reference where the difference frequency can be inside the loop bandwidth (thus the name, integer boundary spurs).

#### Reference Spurs

Reference spurs are generally not a problem in fractional-N synthesizers because the reference offset is far outside the loop bandwidth. However, any reference feedthrough mechanism that bypasses the loop can cause a problem. Feedthrough of low levels of on-chip reference switching noise, through the prescaler back to the VCO, can result in reference spur levels as high as -85 dBc.

### PLL LOCK TIME

The PLL lock time divides into a number of settings. All of these settings are modeled in the [ADIsimPLL](#) design tool.

Much faster lock times than those detailed in this data sheet are possible; contact Analog Devices, Inc., for more information.

#### Lock Time—A Worked Example

Assume that  $f_{PFD} = 61.44$  MHz,

$$VCO \text{ Band Div} = \text{ceiling}(f_{PFD}/1,600,000) = 39 \quad (31)$$

By combining

$$ALC \text{ Wait} > (50 \mu\text{s} \times f_{PFD})/Timeout \quad (32)$$

$$Synthesizer \text{ Lock Timeout} > (20 \mu\text{s} \times f_{PFD})/Timeout \quad (33)$$

It is found that

$$ALC \text{ Wait} = 2.5 \times Synthesizer \text{ Lock Timeout} \quad (34)$$

The ALC wait and synthesizer lock timeout values must be set to fulfill this equation. Both values are five bits wide; therefore, the maximum value for either is 31. There are several suitable values.

The following values meet the criteria:

$$ALC \text{ Wait} = 30 \quad (35)$$

$$Synthesizer \text{ Lock Timeout} = 12 \quad (36)$$

Finally, rearrange as follows:

$$ALC \text{ wait} > (50 \mu\text{s} \times f_{PFD})/Timeout \quad (37)$$

$$Timeout = \text{ceiling}((f_{PFD} \times 50 \mu\text{s})/ALC \text{ Wait}) \quad (38)$$

$$Timeout = \text{ceiling}((61.44 \text{ MHz} \times 50 \mu\text{s})/30) = 103 \quad (39)$$

#### Synthesizer Lock Timeout

The synthesizer lock timeout ensures that the VCO calibration digital-to-analog (DAC), which forces  $V_{TUNE}$ , settles to a steady value for the band select circuitry.

The timeout and synthesizer lock timeout variables programmed in Register 9 select the length of time the DAC is allowed to settle to the final voltage, before the VCO calibration process continues to the next phase, which is VCO band selection. The PFD frequency is the clock for this logic, and the duration is set by

$$\frac{Timeout \times Synthesizer \text{ Lock Timeout}}{f_{PFD}} \quad (40)$$

The calculated time must be equal to or greater than 20  $\mu\text{s}$ .

#### VCO Band Selection

Use the PFD frequency again as the clock for the band selection process. Calculate this value by

$$f_{PFD}/(VCO \text{ Band Selection} \times 16) < 100 \text{ kHz} \quad (41)$$

The band selection takes 11 cycles of the previously calculated value. Calculate the duration by

$$11 \times (VCO \text{ Band Selection} \times 16)/f_{PFD} \quad (42)$$

#### Automatic Level Calibration Timeout

Use the automatic level calibration (ALC) function to choose the correct bias current in the ADF5356 VCO core. Calculate the time taken by

$$30 \times ALC \text{ Wait} \times Timeout/f_{PFD} \quad (43)$$

#### PLL Low-Pass Filter Settling Time

The time taken for the loop to settle is inversely proportional to the low-pass filter bandwidth. The settling time is also modeled in the [ADIsimPLL](#) design tool.

**REGISTER MAPS**

The total lock time for changing frequencies is the sum of the four separate times (synthesizer lock, VCO band selection, ALC

timeout, and PLL settling time) and is modeled in the [ADIsimPLL](#) design tool.

APPLICATIONS INFORMATION

POWER SUPPLIES

The ADF5356 contains four multiband VCOs that cover an octave range of frequencies. To ensure the best performance, it is vital to connect a low noise regulator, such as the [ADM7150](#). Connect the same regulator to the  $V_{VCO}$ ,  $V_{REGVCO}$ , and  $V_P$  pins.

For the 3.3 V supply pins, use one or two ADM7150 regulators, one for the  $DV_{DD}$  and  $AV_{DD}$  supplies and one for  $V_{RF}$ . [Figure 53](#) shows the recommended connections.

PCB DESIGN GUIDELINES FOR A CHIP SCALE PACKAGE

The lands on the 32-lead, lead frame chip scale package are rectangular. The PCB pad for these lands must be 0.1 mm longer than the package land length and 0.05 mm wider than the package land width. Center each land on the pad to maximize the solder joint size.

The bottom of the chip scale package has a central exposed thermal pad. The thermal pad on the PCB must be at least as

large as the exposed pad. On the PCB, there must be a minimum clearance of 0.25 mm between the thermal pad and the inner edges of the pad pattern. This clearance ensures the avoidance of shorting.

To improve the thermal performance of the package, use thermal vias on the PCB thermal pad. If vias are used, incorporate them into the thermal pad at the 1.2 mm pitch grid. The via diameter must be between 0.3 mm and 0.33 mm, and the via barrel must be plated with 1 oz. of copper to plug the via.

For a microwave PLL and VCO synthesizer, such as the ADF5356, take care with the board stackup and layout. Do not consider using FR4 material because it is too lossy above 3 GHz. Instead, Rogers 4350, Rogers 4003, or Rogers 3003 dielectric material is suitable.

Take care with the RF output traces to minimize discontinuities and ensure the best signal integrity. Via placement and grounding are critical.

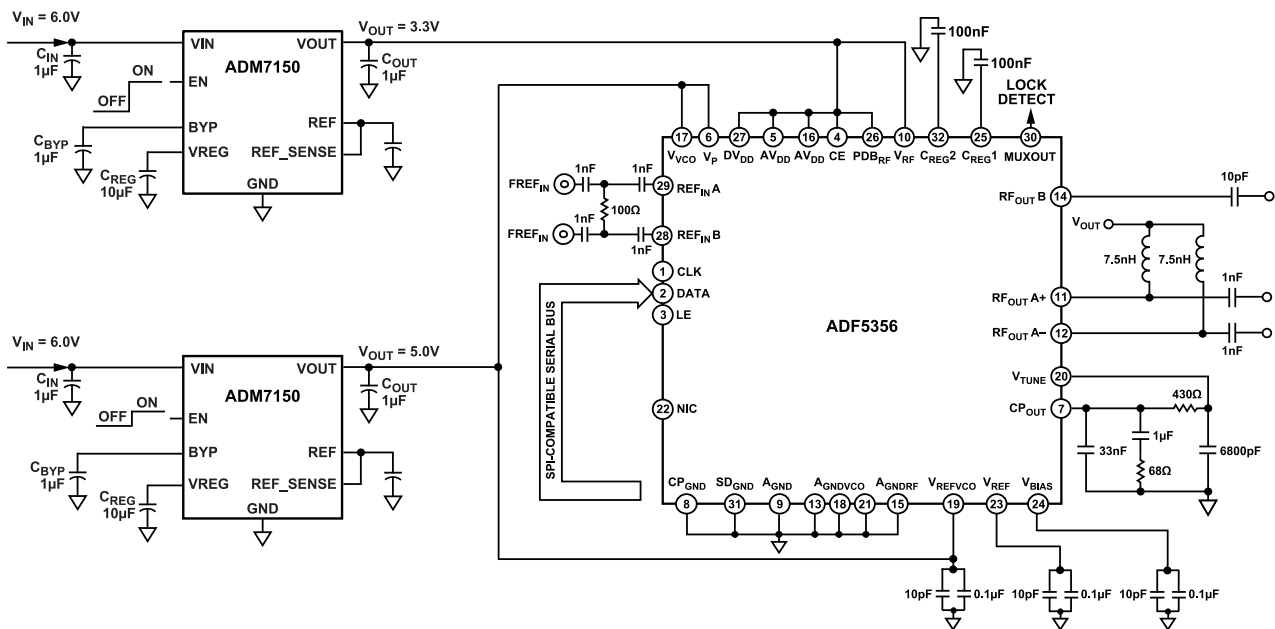

Figure 53. Power Supplies

## APPLICATIONS INFORMATION

## OUTPUT MATCHING

The low frequency output can simply be ac-coupled to the next circuit, if desired; however, if a higher output power is required, use a pull-up inductor to increase the output power level.

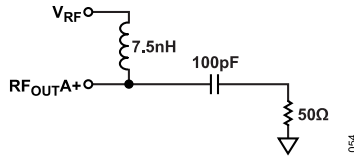

Figure 54. Optimum Output Stage

When differential outputs are not required, terminate the unused output or combine it with both outputs using a balun.

For frequencies below 2 GHz, it is recommended to use a 100 nH inductor on the RF<sub>OUTA+</sub>/RF<sub>OUTA-</sub> pins and a 100 pF ac coupling capacitor.

The RF<sub>OUTA+</sub>/RF<sub>OUTA-</sub> pins form a differential circuit. Provide each output with the same (or similar) components where possible, such as the same shunt inductor value, bypass capacitor, and termination.

AC couple the higher frequency output, RF<sub>OUTB</sub>, directly to the next appropriate circuit stage.

RF<sub>OUTB</sub> is matched internally to a 50 Ω impedance and requires no additional matching components.



OUTLINE DIMENSIONS

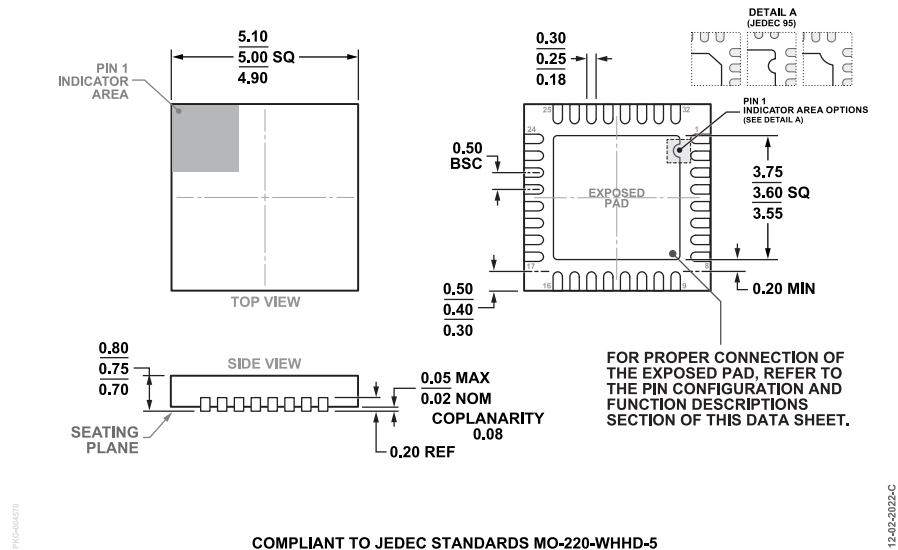

**Figure 55. 32-Lead Lead Frame Chip Scale Package [LFCSP]  
5 mm × 5 mm Body and 0.75 mm Package Height  
(CP-32-12)  
Dimensions shown in millimeters**

Updated: February 27, 2023

ORDERING GUIDE

Model <sup>1</sup>	Temperature Range	Package Description	Packing Quantity	Package Option
ADF5356BCPZ	-40°C to +85°C	32-Lead LFCSP (5mm x 5mm x 0.75mm w/ EP)		CP-32-12
ADF5356BCPZ-RL7	-40°C to +85°C	32-Lead LFCSP (5mm x 5mm x 0.75mm w/ EP)	Reel, 1500	CP-32-12

<sup>1</sup> Z = RoHS Compliant Part.

EVALUATION BOARDS

Model <sup>1</sup>	Description
EV-ADF5356SD1Z	Evaluation Board

<sup>1</sup> Z = RoHS Compliant Part.

# Mouser Electronics

Authorized Distributor

Click to View Pricing, Inventory, Delivery & Lifecycle Information:

[Analog Devices Inc.:](#)

[EV-ADF5356SD1Z](#) [ADF5356BCPZ](#) [ADF5356BCPZ-RL7](#)