



### FEATURES

- 1.8 V to 5.5 V single-supply operation
- ±2.5 V dual-supply operation
- On resistance: 4 Ω at 25°C (+5 V single supply/±2.5 V dual supply)
- 0.5 Ω on-resistance flatness at 25°C (+5 V single supply/±2.5 V dual supply)
- Rail-to-rail operation
- Transition times: 23 ns typical at 25°C
- Single 32-to-1 channel multiplexer
- Dual/differential 16-to-1 channel multiplexer
- TTL-/CMOS-compatible inputs
- 48-lead TQFP or 48-lead, 7 mm × 7 mm LFCSP

### APPLICATIONS

- Optical applications
- Data acquisition systems
- Communication systems
- Relay replacement
- Audio and video switching
- Battery-powered systems
- Medical instrumentation
- Automatic test equipment (ATE)

### GENERAL DESCRIPTION

The [ADG726/ADG732](#) are monolithic, complementary metal oxide semiconductor (CMOS) 32-channel and dual 16-channel analog multiplexers. The [ADG732](#) switches one of 32 inputs (S1 to S32) to a common output, D, as determined by the 5-bit binary address lines A0, A1, A2, A3, and A4. The [ADG726](#) switches one of 16 inputs as determined by the 4-bit binary address lines A0, A1, A2, and A3.

On-chip latches facilitate microprocessor interfacing. The [ADG726](#) may also be configured for differential operation by tying  $\overline{CSA}$  and  $\overline{CSB}$  together. An  $\overline{EN}$  input is used to enable or disable the devices. When disabled, all channels are switched off.

These multiplexers are designed on an enhanced submicron process that provides low power dissipation yet gives high switching speed, very low on resistance, and leakage currents. They operate from a single supply of +1.8 V to +5.5 V and a ±2.5 V dual supply, making them ideally suited to a variety of applications. On resistance is in the region of a few ohms and is

Rev. C

[Document Feedback](#)

Information furnished by Analog Devices is believed to be accurate and reliable. However, no responsibility is assumed by Analog Devices for its use, nor for any infringements of patents or other rights of third parties that may result from its use. Specifications subject to change without notice. No license is granted by implication or otherwise under any patent or patent rights of Analog Devices. Trademarks and registered trademarks are the property of their respective owners.

### FUNCTIONAL BLOCK DIAGRAMS

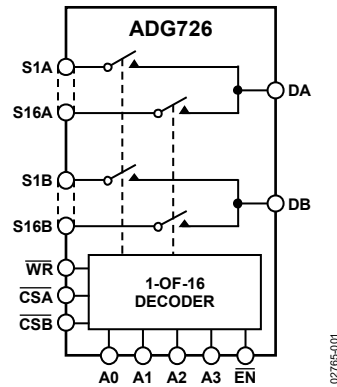

Figure 1.

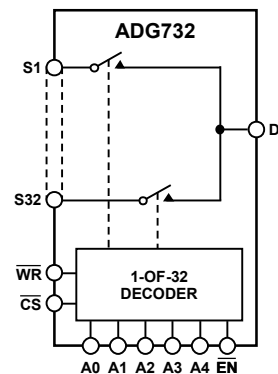

Figure 2.

closely matched between switches and very flat over the full signal range. These devices can operate equally well as either multiplexers or demultiplexers and have an input signal range that extends to the supplies. In the off condition, signal levels up to the supplies are blocked. All channels exhibit break-before-make switching action, preventing momentary shorting when switching channels.

The [ADG726/ADG732](#) are available in a 48-lead LFCSP or a 48-lead TQFP. For functionally equivalent devices with serial interface, see the [ADG725/ADG731](#).

### PRODUCT HIGHLIGHTS

- +1.8 V to +5.5 V single- or ±2.5 V dual-supply operation. These devices are specified and guaranteed with +5 V ± 10%, +3 V ± 10% single-supply, and ±2.5 V ± 10% dual-supply rails.
- An on resistance of 4 Ω.
- Guaranteed break-before-make switching action.
- 48-lead LFCSP package or 48-lead TQFP package.

**TABLE OF CONTENTS**

Features ..... 1  
 Applications ..... 1  
 Functional Block Diagrams..... 1  
 General Description ..... 1  
 Product Highlights..... 1  
 Revision History ..... 2  
 Specifications ..... 3  
     +5 V Single Supply ..... 3  
     +3 V Single Supply ..... 5  
     ±2.5 V Dual Supply ..... 7  
     Timing Characteristics ..... 8

Absolute Maximum Ratings .....9  
     ESD Caution .....9  
 Pin Configurations and Function Description ..... 10  
     48-Lead TQFP ..... 10  
     48-Lead LFCSP ..... 12  
 Typical Performance Characteristics ..... 15  
 Test Circuits ..... 17  
 Terminology..... 20  
 Outline Dimensions..... 21  
     Ordering Guide ..... 21

**REVISION HISTORY**

**2/2021—Rev. B to Rev. C**

Changed CP-48-1 to CP-48-4..... Throughout  
 Changes to Figure 6..... 12  
 Changes to Figure 7..... 13  
 Updated Outline Dimensions..... 21  
 Changes to Ordering Guide..... 21

**6/2015—Rev. A to Rev. B**

Changes to Figure 4 and Table 6 ..... 10  
 Added Figure 5 and Table 7; Renumbered Sequentially ..... 11  
 Added Figure 6 and Table 8..... 12  
 Changes to Figure 7, Table 9, and Table 10 ..... 13  
 Changes to Table 11 ..... 14

**2/2015—Rev. 0 to Rev. A**

Updated Format ..... Universal  
 Changes to Features Section ..... 1  
 Changes to Table 1 ..... 3

Changes to Table 2 .....5  
 Changes to Table 3 .....7  
 Changes to Table 5 .....9  
 Added Table 6; Renumbered Sequentially ..... 10  
 Added Table 7 ..... 11  
 Changes to Figure 5 ..... 11  
 Changes to Figure 8 to Figure 11 ..... 13  
 Changes to Figure 13 and Figure 15 to Figure 17 ..... 14  
 Changes to Figure 25 to Figure 28 ..... 16  
 Changes to Figure 29 ..... 17  
 Moved Terminology Section ..... 18  
 Changes to Terminology Section ..... 18  
 Updated Outline Dimensions ..... 19  
 Changes to Ordering Guide..... 19

**7/2002—Revision 0: Initial Version**

## SPECIFICATIONS

## +5 V SINGLE SUPPLY

$V_{DD} = 5\text{ V} \pm 10\%$ ,  $V_{SS} = 0\text{ V}$ ,  $GND = 0\text{ V}$ , unless otherwise noted.

Table 1.

Parameter	Symbol	ADG726/ADG732		ADG732	Unit	Test Conditions/Comments
		+25°C	-40°C to +85°C	-40°C to +125°C		
<b>ANALOG SWITCH</b>						
Analog Signal Range			0 V to $V_{DD}$		V	
On Resistance	$R_{ON}$	4	5		$\Omega$ typ	$V_S = 0\text{ V to }V_{DD}$ , $I_{DS} = 10\text{ mA}$ , see Figure 20
		5.5	6	7	$\Omega$ max	
On Resistance Match Between Channels	$\Delta R_{ON}$		0.3		$\Omega$ typ	$V_S = 0\text{ V to }V_{DD}$ , $I_{DS} = 10\text{ mA}$
			0.8	1	$\Omega$ max	
On Resistance Flatness	$R_{FLAT(ON)}$	0.5			$\Omega$ typ	$V_S = 0\text{ V to }V_{DD}$ , $I_{DS} = 10\text{ mA}$
			1	1.2	$\Omega$ max	
<b>LEAKAGE CURRENTS</b>						
Source Off Leakage	$I_S$ (Off)	$\pm 0.01$			nA typ	$V_{DD} = 5.5\text{ V}$
		$\pm 0.25$	$\pm 1$	$\pm 2$	nA max	$V_D = 4.5\text{ V}/1\text{ V}$ , $V_S = 1\text{ V}/4.5\text{ V}$ , see Figure 21
Drain Off Leakage	$I_D$ (Off)	$\pm 0.05$			nA typ	$V_D = 4.5\text{ V}/1\text{ V}$ , $V_S = 1\text{ V}/4.5\text{ V}$ , see Figure 24
		$\pm 0.5$	$\pm 2.5$		nA max	
		$\pm 1$	$\pm 5$	$\pm 10$	nA max	
Channel On Leakage	$I_D, I_S$ (On)	$\pm 0.05$			nA typ	$V_D = V_S = 1\text{ V}$ , or 4.5 V, see Figure 25
		$\pm 0.5$	$\pm 2.5$		nA max	
		$\pm 1$	$\pm 5$	$\pm 10$	nA max	
<b>DIGITAL INPUTS</b>						
Input High Voltage	$V_{INH}$		2.4	2.4	V min	
Input Low Voltage	$V_{INL}$		0.8	0.8	V max	
Input Current						
Low or High	$I_{INL}$ or $I_{INH}$	0.005			$\mu\text{A}$ typ	$V_{IN} = V_{INL}$ or $V_{INH}$
			$\pm 0.5$	$\pm 0.5$	$\mu\text{A}$ max	
Digital Input Capacitance	$C_{IN}$	5			pF typ	
<b>DYNAMIC CHARACTERISTICS<sup>1</sup></b>						
Transition Time	$t_{TRANSITION}$	23			ns typ	$R_L = 300\ \Omega$ , $C_L = 35\text{ pF}$ , see Figure 27
		34	40	48	ns max	$V_{S1} = 3\text{ V}/0\text{ V}$ , $V_{S32} = 0\text{ V}/3\text{ V}$
Break-Before-Make Time Delay	$t_D$	18			ns typ	$R_L = 300\ \Omega$ , $C_L = 35\text{ pF}$ ; $V_S = 3\text{ V}$ , see Figure 28
			1	1	ns min	
On Time ( $\overline{CS}$ , $\overline{WR}$ )	$t_{ON}(\overline{CS}, \overline{WR})$	18			ns typ	$R_L = 300\ \Omega$ , $C_L = 35\text{ pF}$ ; $V_S = 3\text{ V}$ , see Figure 29
		25	32	38.5	ns max	
Off Time ( $\overline{CS}$ , $\overline{WR}$ )	$t_{OFF}(\overline{CS}, \overline{WR})$	17			ns typ	$R_L = 300\ \Omega$ , $C_L = 35\text{ pF}$ ; $V_S = 3\text{ V}$ , see Figure 29
		23	29	33	ns max	
On Time ( $\overline{EN}$ )	$t_{ON}(\overline{EN})$	24			ns typ	$R_L = 300\ \Omega$ , $C_L = 35\text{ pF}$ ; $V_S = 3\text{ V}$ , see Figure 30
		32	40	43	ns max	
Off Time ( $\overline{EN}$ )	$t_{OFF}(\overline{EN})$	16			ns typ	$R_L = 300\ \Omega$ , $C_L = 35\text{ pF}$ ; $V_S = 3\text{ V}$ , see Figure 30
		22	25	25	ns max	
Charge Injection	$Q_{INJ}$	5			pC typ	$V_S = 2.5\text{ V}$ , $R_S = 0\ \Omega$ , $C_L = 1\text{ nF}$ , see Figure 31
Off Isolation	$I_{SO}$	-72			dB typ	$R_L = 50\ \Omega$ , $C_L = 5\text{ pF}$ , $f = 1\text{ MHz}$ , see Figure 22
Channel-to-Channel Crosstalk	$C_{TK}$	-72			dB typ	$R_L = 50\ \Omega$ , $C_L = 5\text{ pF}$ , $f = 1\text{ MHz}$ , see Figure 23
-3 dB Bandwidth	BW					$R_L = 50\ \Omega$ , $C_L = 5\text{ pF}$ , see Figure 26
		34			MHz typ	
		18			MHz typ	

Parameter	Symbol	ADG726/ADG732		ADG732	Unit	Test Conditions/Comments
		+25°C	-40°C to +85°C	-40°C to +125°C		
Off Switch Source Capacitance	C <sub>S</sub> (Off)	13			pF typ	f = 1 MHz
Off Switch Drain Capacitance	C <sub>D</sub> (Off)	170			pF typ	f = 1 MHz
ADG726		340			pF typ	f = 1 MHz
ADG732						
On Switch Drain, Source Capacitance	C <sub>D</sub> , C <sub>S</sub> (On)	175			pF typ	f = 1 MHz
ADG726		350			pF typ	f = 1 MHz
ADG732						
POWER REQUIREMENTS						
Positive Supply Current	I <sub>DD</sub>	10	20	20	μA typ μA max	V <sub>DD</sub> = 5.5 V Digital inputs = 0 V or 5.5 V

<sup>1</sup> Guaranteed by design; not subject to production test.

**+3 V SINGLE SUPPLY**

$V_{DD} = 3\text{ V} \pm 10\%$ ,  $V_{SS} = 0\text{ V}$ ,  $GND = 0\text{ V}$ , unless otherwise noted.

**Table 2.**

Parameter	Symbol	ADG726/ADG732		ADG732	Unit	Test Conditions/Comments
		+25°C	−40°C to +85°C	−40°C to +125°C		
<b>ANALOG SWITCH</b>						
Analog Signal Range			0 V to $V_{DD}$		V	
On Resistance	$R_{ON}$	7	12	13	$\Omega$ typ $\Omega$ max	$V_S = 0\text{ V to }V_{DD}$ , $I_{DS} = 10\text{ mA}$ , see Figure 20
On Resistance Match Between Channels	$\Delta R_{ON}$	11	0.35		$\Omega$ typ	$V_S = 0\text{ V to }V_{DD}$ , $I_{DS} = 10\text{ mA}$
On Resistance Flatness	$R_{FLAT(ON)}$		1 3	1	$\Omega$ max $\Omega$ typ	$V_S = 0\text{ V to }V_{DD}$ , $I_{DS} = 10\text{ mA}$
<b>LEAKAGE CURRENTS</b>						
Source Off Leakage	$I_S$ (Off)	$\pm 0.01$ $\pm 0.25$	$\pm 1$	$\pm 2$	nA typ nA max	$V_{DD} = 3.3\text{ V}$ $V_S = 3\text{ V}/1\text{ V}$ , $V_D = 1\text{ V}/3\text{ V}$ , see Figure 21
Drain Off Leakage	$I_D$ (Off)	$\pm 0.05$ $\pm 0.5$	$\pm 2.5$		nA typ nA max	$V_S = 1\text{ V}/3\text{ V}$ , $V_D = 3\text{ V}/1\text{ V}$ , see Figure 24
Channel On Leakage	$I_D, I_S$ (On)	$\pm 0.05$ $\pm 0.5$ $\pm 1$	$\pm 5$ $\pm 2.5$ $\pm 5$	$\pm 10$ $\pm 10$	nA max nA typ nA max	$V_S = V_D = 1\text{ V or }3\text{ V}$ , see Figure 25
<b>DIGITAL INPUTS</b>						
Input High Voltage	$V_{INH}$		2.0	2.0	V min	
Input Low Voltage	$V_{INL}$		0.7	0.7	V max	
Input Current	$I_{INL}$ or $I_{INH}$	0.005	$\pm 0.5$	$\pm 0.5$	$\mu\text{A}$ typ $\mu\text{A}$ max	$V_{IN} = V_{INL}$ or $V_{INH}$
Digital Input Capacitance	$C_{IN}$	5			pF typ	
<b>DYNAMIC CHARACTERISTICS<sup>1</sup></b>						
Transition Time	$t_{TRANSITION}$	34 52	62	69	ns typ ns max	$R_L = 300\ \Omega$ , $C_L = 35\text{ pF}$ , see Figure 27 $V_{S1} = 2\text{ V}/0\text{ V}$ , $V_{S32} = 0\text{ V}/2\text{ V}$
Break-Before-Make Time Delay	$t_D$	26	1	1	ns typ ns min	$R_L = 300\ \Omega$ , $C_L = 35\text{ pF}$ ; $V_S = 2\text{ V}$ , see Figure 28
On Time ( $\overline{CS}$ , $\overline{WR}$ )	$t_{ON}(\overline{WR}, \overline{CS})$	29			ns typ	$R_L = 300\ \Omega$ , $C_L = 35\text{ pF}$ ; $V_S = 2\text{ V}$ , see Figure 29
Off Time ( $\overline{CS}$ , $\overline{WR}$ )	$t_{OFF}(\overline{WR}, \overline{CS})$	43 26	52	60	ns max ns typ	$R_L = 300\ \Omega$ , $C_L = 35\text{ pF}$ ; $V_S = 2\text{ V}$ , see Figure 29
On Time ( $\overline{EN}$ )	$t_{ON}(\overline{EN})$	38 33	42	55.5	ns max ns typ	$R_L = 300\ \Omega$ , $C_L = 35\text{ pF}$ ; $V_S = 2\text{ V}$ , see Figure 30
Off Time ( $\overline{EN}$ )	$t_{OFF}(\overline{EN})$	48 19	55	63.5	ns max ns typ	$R_L = 300\ \Omega$ , $C_L = 35\text{ pF}$ ; $V_S = 2\text{ V}$ , see Figure 30
Charge Injection	$Q_{INJ}$	25	28	28	ns max pC typ	$V_S = 1.5\text{ V}$ , $R_S = 0\ \Omega$ , $C_L = 1\text{ nF}$ , see Figure 31
Off Isolation	$I_{SO}$	1			dB typ	$R_L = 50\ \Omega$ , $C_L = 5\text{ pF}$ , $f = 1\text{ MHz}$ , see Figure 22
Channel-to-Channel Crosstalk	$C_{TK}$	−72			dB typ	$R_L = 50\ \Omega$ , $C_L = 5\text{ pF}$ , $f = 1\text{ MHz}$ , see Figure 23
−3 dB Bandwidth	BW	−72			dB typ	$R_L = 50\ \Omega$ , $C_L = 5\text{ pF}$ , see Figure 26
		34			MHz typ	
		18			MHz typ	

Parameter	Symbol	ADG726/ADG732		ADG732	Unit	Test Conditions/Comments
		+25°C	-40°C to +85°C	-40°C to +125°C		
Off Switch Source Capacitance	C <sub>S</sub> (Off)	13			pF typ	f = 1 MHz
Off Switch Drain Capacitance	C <sub>D</sub> (Off)	170			pF typ	f = 1 MHz
		340			pF typ	f = 1 MHz
On Switch Drain, Source Capacitance	C <sub>D</sub> , C <sub>S</sub> (On)					
		175			pF typ	f = 1 MHz
		350			pF typ	f = 1 MHz
POWER REQUIREMENTS						
Positive Supply Current	I <sub>DD</sub>	5	10	10	μA typ μA max	V <sub>DD</sub> = 3.3 V Digital inputs = 0 V or 3.3 V

<sup>1</sup> Guaranteed by design; not subject to production test.

**±2.5 V DUAL SUPPLY**

$V_{DD} = +2.5\text{ V} \pm 10\%$ ,  $V_{SS} = -2.5\text{ V} \pm 10\%$ ,  $GND = 0\text{ V}$ , unless otherwise noted.

Table 3.

Parameter	Symbol	ADG726/ADG732		ADG732	Unit	Test Conditions/Comments
		+25°C	−40°C to +85°C	−40°C to +125°C		
<b>ANALOG SWITCH</b>						
Analog Signal Range			$V_{SS}$ to $V_{DD}$		V	
On Resistance	$R_{ON}$	4 5.5	6	7	$\Omega$ typ $\Omega$ max	$V_S = V_{SS}$ to $V_{DD}$ , $I_{DS} = 10\text{ mA}$ , see Figure 20
On Resistance Match Between Channels	$\Delta R_{ON}$		0.3		$\Omega$ typ	$V_S = V_{SS}$ to $V_{DD}$ , $I_{DS} = 10\text{ mA}$
On Resistance Flatness	$R_{FLAT(ON)}$	0.5	0.8 1	1 1.2	$\Omega$ max $\Omega$ typ $\Omega$ max	$V_S = V_{SS}$ to $V_{DD}$ , $I_{DS} = 10\text{ mA}$
<b>LEAKAGE CURRENTS</b>						
Source Off Leakage	$I_S$ (Off)	$\pm 0.01$			nA typ	$V_{DD} = +2.75\text{ V}$ , $V_{SS} = -2.75\text{ V}$ $V_S = +2.25\text{ V}/-1.25\text{ V}$ , $V_D = -1.25\text{ V}/+2.25\text{ V}$ , see Figure 21
Drain Off Leakage	$I_D$ (Off)	$\pm 0.25$ $\pm 0.05$	$\pm 0.5$	$\pm 1$	nA max nA typ	$V_S = +2.25\text{ V}/-1.25\text{ V}$ , $V_D = -1.25\text{ V}/+2.25\text{ V}$ , see Figure 24
Channel On Leakage	$I_D, I_S$ (On)	$\pm 0.5$ $\pm 1$ $\pm 0.05$ $\pm 0.5$ $\pm 1$	$\pm 2.5$ $\pm 5$ $\pm 2.5$ $\pm 2.5$ $\pm 5$	$\pm 10$ $\pm 10$	nA max nA max nA typ nA max nA max	$V_S = V_D = +2.25\text{ V}/-1.25\text{ V}$ , see Figure 25
<b>DIGITAL INPUTS</b>						
Input High Voltage	$V_{INH}$		1.7	1.7	V min	
Input Low Voltage	$V_{INL}$		0.7	0.7	V max	
Input Current	$I_{INL}$ or $I_{INH}$	0.005	$\pm 0.5$	$\pm 0.5$	$\mu\text{A}$ typ $\mu\text{A}$ max	$V_{IN} = V_{INL}$ or $V_{INH}$
Digital Input Capacitance	$C_{IN}$	5			pF typ	
<b>DYNAMIC CHARACTERISTICS<sup>1</sup></b>						
Transition Time	$t_{TRANSITION}$	33 45	51	56	ns typ ns max	$R_L = 300\ \Omega$ , $C_L = 35\text{ pF}$ , see Figure 27 $V_{S1} = 1.5\text{ V}/0\text{ V}$ , $V_{S32} = 0\text{ V}/1.5\text{ V}$
Break-Before-Make Time Delay	$t_D$	15	1	1	ns typ ns min	$R_L = 300\ \Omega$ , $C_L = 35\text{ pF}$ ; $V_S = 1.5\text{ V}$ , see Figure 28
On Time ( $\overline{CS}$ , $\overline{WR}$ )	$t_{ON}(\overline{WR}, \overline{CS})$	21			ns typ	$R_L = 300\ \Omega$ , $C_L = 35\text{ pF}$ ; $V_S = 1.5\text{ V}$ , see Figure 29
Off Time ( $\overline{CS}$ , $\overline{WR}$ )	$t_{OFF}(\overline{WR}, \overline{CS})$	30 20	37	43	ns max ns typ	$R_L = 300\ \Omega$ , $C_L = 35\text{ pF}$ ; $V_S = 1.5\text{ V}$ , see Figure 29
On Time ( $\overline{EN}$ )	$t_{ON}(\overline{EN})$	29 26	35	38	ns max ns typ	$R_L = 300\ \Omega$ , $C_L = 35\text{ pF}$ ; $V_S = 1.8\text{ V}$ , see Figure 30
Off Time ( $\overline{EN}$ )	$t_{OFF}(\overline{EN})$	37 18		50	ns max ns typ	$R_L = 300\ \Omega$ , $C_L = 35\text{ pF}$ ; $V_S = 1.8\text{ V}$ , see Figure 30
Charge Injection	$Q_{INJ}$	26 1	29	29	ns max pC typ	$V_S = 0\text{ V}$ , $R_S = 0\ \Omega$ , $C_L = 1\text{ nF}$ , see Figure 31
Off Isolation	$I_{SO}$	−72			dB typ	$R_L = 50\ \Omega$ , $C_L = 5\text{ pF}$ , $f = 1\text{ MHz}$ , see Figure 22
Channel-to-Channel Crosstalk	$C_{TK}$	−72			dB typ	$R_L = 50\ \Omega$ , $C_L = 5\text{ pF}$ , $f = 1\text{ MHz}$ , see Figure 23
−3 dB Bandwidth	BW					$R_L = 50\ \Omega$ , $C_L = 5\text{ pF}$ , see Figure 26
		34			MHz typ	
		18			MHz typ	

Parameter	Symbol	ADG726/ADG732		ADG732	Unit	Test Conditions/Comments
		+25°C	-40°C to +85°C	-40°C to +125°C		
Off Switch Source Capacitance	C <sub>S</sub> (Off)	13			pF typ	
Off Switch Drain Capacitance	C <sub>D</sub> (Off)				pF typ	f = 1 MHz
ADG726		137			pF typ	f = 1 MHz
ADG732		275			pF typ	f = 1 MHz
On Switch Drain, Source Capacitance	C <sub>D</sub> , C <sub>S</sub> (On)				pF typ	f = 1 MHz
ADG726		150			pF typ	f = 1 MHz
ADG732		300			pF typ	f = 1 MHz
<b>POWER REQUIREMENTS</b>						
Positive Supply Current	I <sub>DD</sub>	10			μA typ	V <sub>DD</sub> = 2.75 V
Negative Supply Current	I <sub>SS</sub>	10	20	20	μA max	Digital inputs = 0 V or 2.75 V
			20	20	μA typ	V <sub>DD</sub> = -2.75 V
					μA max	Digital inputs = 0 V or 2.75 V

<sup>1</sup> Guaranteed by design; not subject to production test.

**TIMING CHARACTERISTICS**

Table 4.

Parameter <sup>1, 2, 3</sup>	Limit at T <sub>MIN</sub> , T <sub>MAX</sub>	Unit	Test Conditions/Comments
t <sub>1</sub>	0	ns min	$\overline{CS}$ to $\overline{WR}$ setup time
t <sub>2</sub>	0	ns min	$\overline{CS}$ to $\overline{WR}$ hold time
t <sub>3</sub>	10	ns min	$\overline{WR}$ pulse width
t <sub>4</sub>	10	ns min	Time between $\overline{WR}$ cycles
t <sub>5</sub>	5	ns min	Address, enable setup time
t <sub>6</sub>	2	ns min	Address, enable hold time

<sup>1</sup> See Figure 3.

<sup>2</sup> All input signals are specified with t<sub>r</sub> = t<sub>f</sub> = 1 ns (10% to 90% of V<sub>DD</sub>).

<sup>3</sup> Guaranteed by design and characterization, not production tested.

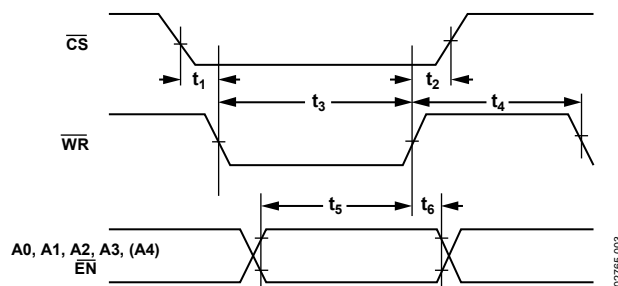

Figure 3. Timing Diagram

Figure 3 shows the timing sequence for latching the switch address and enable inputs. The latches are level sensitive; therefore, while  $\overline{WR}$  is held low, the latches are transparent and the switches respond to changing the address and enable the inputs.

Input data is latched on the rising edge of  $\overline{WR}$ . The ADG726 has two  $\overline{CS}$  inputs. This enables the device to be used either as a dual 16-to-1 channel multiplexer or a differential 16-channel multiplexer. If a differential output is required, tie  $\overline{CSA}$  and  $\overline{CSB}$  together.



## ABSOLUTE MAXIMUM RATINGS

$T_A = 25^\circ\text{C}$ , unless otherwise noted.

Table 5.

Parameter	Rating
$V_{DD}$ to $V_{SS}$	7 V
$V_{DD}$ to GND	-0.3 V to +7 V
$V_{SS}$ to GND	+0.3 V to -7 V
Analog Inputs <sup>1</sup>	$V_{SS} - 0.3$ V to $V_{DD} + 0.3$ V or 30 mA, whichever occurs first
Digital Inputs <sup>1</sup>	-0.3 V to $V_{DD} + 0.3$ V or 30 mA, whichever occurs first
Peak Current, S or D (Pulsed at 1 ms, 10% Duty Cycle Maximum)	60 mA
Continuous Current, S or D	30 mA
Operating Temperature Range	
ADG726	-40°C to +85°C
ADG732	-40°C to +125°C
Storage Temperature Range	-65°C to +150°C
Junction Temperature	150°C
Thermal Impedance $\theta_{JA}$ (4-Layer Board)	
48-Lead LFCSP	25°C/W
48-Lead TQFP	54.6°C/W
Reflow Soldering Peak Temperature, Pb Free	As per JEDEC J-STD-020

<sup>1</sup> Overvoltages at A,  $\overline{EN}$ ,  $\overline{WR}$ ,  $\overline{CS}$ , S, or D will be clamped by internal diodes. Current should be limited to the maximum ratings given.

Stresses at or above those listed under Absolute Maximum Ratings may cause permanent damage to the product. This is a stress rating only; functional operation of the product at these or any other conditions above those indicated in the operational section of this specification is not implied. Operation beyond the maximum operating conditions for extended periods may affect product reliability.

### ESD CAUTION



**ESD (electrostatic discharge) sensitive device.** Charged devices and circuit boards can discharge without detection. Although this product features patented or proprietary protection circuitry, damage may occur on devices subjected to high energy ESD. Therefore, proper ESD precautions should be taken to avoid performance degradation or loss of functionality.

**PIN CONFIGURATIONS AND FUNCTION DESCRIPTION**  
**48-LEAD TQFP**

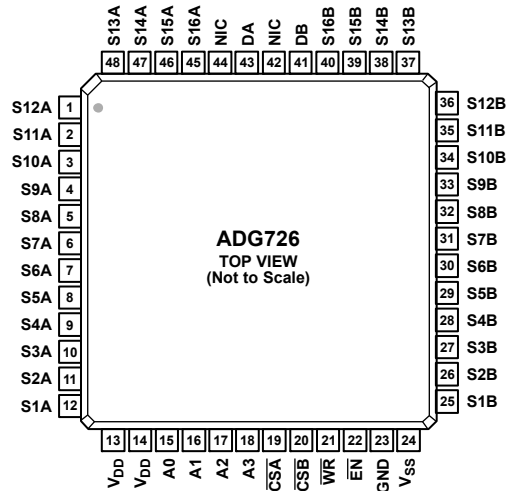

NOTES  
 1. NIC = NOT INTERNALLY CONNECTED. DO NOT CONNECT TO THIS PIN.

Figure 4. ADG726 Pin Configuration

Table 6. ADG726 Pin Function Description

Pin No.	Mnemonic	Description
1 to 12, 45 to 48	S16A to S1A	Source Terminal. This pin may be an input or output.
13, 14	V <sub>DD</sub>	Most Positive Power Supply Potential.
15 to 18	A0 to A3	Logic Control Inputs.
19	$\overline{CSA}$	Chip Select Pin A. $\overline{CSA}$ is active low. If a differential output configuration is required, tie $\overline{CSA}$ and $\overline{CSB}$ together.
20	$\overline{CSB}$	Chip Select Pin B. $\overline{CSB}$ is active low. If a differential output configuration is required, tie $\overline{CSB}$ and $\overline{CSA}$ together.
21	$\overline{WR}$	Write pin. When $\overline{WR}$ is low, the logic control inputs (A0 to A3) control which state the switches are in. On the rising edge of $\overline{WR}$ , the logic control input data is latched.
22	$\overline{EN}$	Active Low, Digital Input. When this pin is high, the device is disabled and all switches are off. When this pin is low, the Ax logic control inputs determine the on switches. The $\overline{EN}$ input signal is not latched by $\overline{WR}$ .
23	GND	Ground (0 V) Reference.
24	V <sub>SS</sub>	Most Negative Power Supply in a Dual-Supply Application. In single-supply applications, connect this pin to GND.
25 to 40	S1B to S16B	Source Terminal. This pin may be an input or output.
41	DB	Drain Terminal. This pin may be an input or output.
42, 44	NIC	Not Internally Connected. Do not connect to this pin.
43	DA	Drain Terminal. This pin may be an input or output.

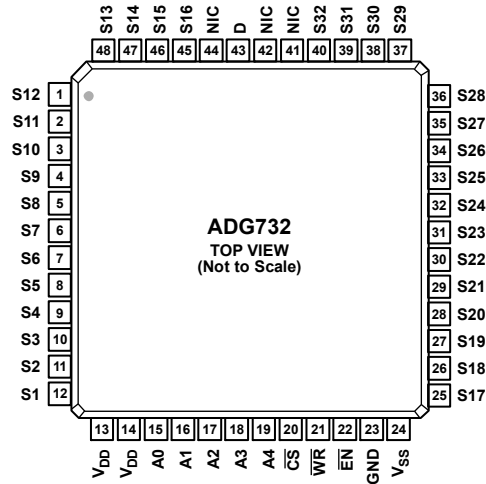

NOTES  
 1. NIC = NOT INTERNALLY CONNECTED. DO NOT CONNECT TO THIS PIN.

Figure 5. ADG732 Pin Configuration

02765-104

Table 7. ADG732 Pin Function Description

Pin No.	Mnemonic	Description
1 to 12, 45 to 48	S16 to S1	Source Terminal. This pin may be an input or output.
13, 14	V <sub>DD</sub>	Most Positive Power Supply Potential.
15 to 19	A0 to A4	Logic Control Inputs.
20	$\overline{CS}$	Chip Select Pin. $\overline{CS}$ is active low.
21	$\overline{WR}$	Write Pin. When $\overline{WR}$ is low, the logic control inputs (A0 to A4) control which state the switches are in. On the rising edge of $\overline{WR}$ , the logic control input data is latched.
22	$\overline{EN}$	Active Low, Digital Input. When this pin is high, the device is disabled and all switches are off. When this pin is low, the A <sub>x</sub> logic control inputs determine the on switches. The $\overline{EN}$ input signal is not latched by $\overline{WR}$ .
23	GND	Ground (0 V) Reference.
24	V <sub>SS</sub>	Most Negative Power Supply in a Dual-Supply Application. In single-supply applications, connect this pin to GND.
25 to 40	S17 to S32	Source Terminal. This pin may be an input or output.
41, 42, 44	NIC	Not Internally Connected. Do not connect to this pin.
43	D	Drain Terminal. This pin may be an input or output.

48-LEAD LFCSP

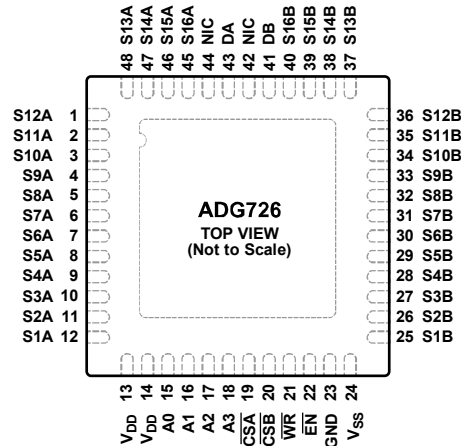

NOTES  
 1. NIC = NOT INTERNALLY CONNECTED. DO NOT CONNECT TO THIS PIN.  
 2. THE EXPOSED PAD MUST BE CONNECTED TO GND.

02765-105

Figure 6. ADG726 Pin Configuration

Table 8. ADG726 Pin Function Description

Pin No.	Mnemonic	Description
1 to 12, 45 to 48	S16A to S1A	Source Terminal. This pin may be an input or output.
13, 14	V <sub>DD</sub>	Most Positive Power Supply Potential.
15 to 18	A0 to A3	Logic Control Inputs.
19	$\overline{CSA}$	Chip Select Pin A. $\overline{CSA}$ is active low. If a differential output configuration is required, tie $\overline{CSA}$ and $\overline{CSB}$ together.
20	$\overline{CSB}$	Chip Select Pin B. $\overline{CSB}$ is active low. If a differential output configuration is required, tie $\overline{CSB}$ and $\overline{CSA}$ together.
21	$\overline{WR}$	Write pin. When $\overline{WR}$ is low, the logic control inputs (A0 to A3) control which state the switches are in. On the rising edge of $\overline{WR}$ , the logic control input data is latched.
22	$\overline{EN}$	Active Low, Digital Input. When this pin is high, the device is disabled and all switches are off. When this pin is low, the Ax logic control inputs determine the on switches. The EN input signal is not latched by $\overline{WR}$ .
23	GND	Ground (0 V) Reference.
24	V <sub>SS</sub>	Most Negative Power Supply in a Dual-Supply Application. In single-supply applications, connect this pin to GND.
25 to 40	S1B to S16B	Source Terminal. This pin may be an input or output.
41	DB	Drain Terminal. This pin may be an input or output.
42, 44	NIC	Not Internally Connected. Do not connect to this pin.
43	DA	Drain Terminal. This pin may be an input or output.
	EPAD	Exposed Pad. The exposed pad must be connected to GND.

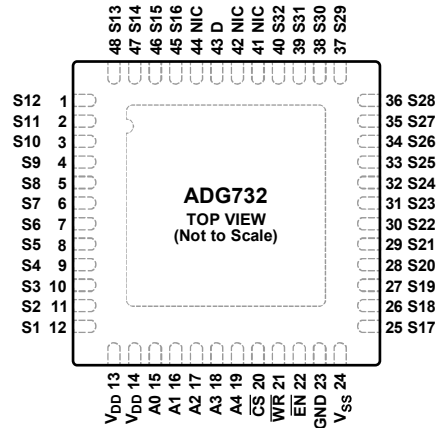

- NOTES**  
 1. NIC = NOT INTERNALLY CONNECTED. DO NOT CONNECT TO THIS PIN.  
 2. THE EXPOSED PAD MUST BE CONNECTED TO GND.

02765-004

Figure 7. ADG732 Pin Configuration

Table 9. ADG732 Pin Function Description

Pin No.	Mnemonic	Description
1 to 12, 45 to 48 13, 14	S16 to S1 V <sub>DD</sub>	Source Terminal. This pin may be an input or output. Most Positive Power Supply Potential.
15 to 19	A0 to A4	Logic Control Inputs.
20	$\overline{CS}$	Chip Select Pin. $\overline{CS}$ is active low.
21	$\overline{WR}$	Write Pin. When $\overline{WR}$ is low, the logic control inputs (A0 to A4) control which state the switches are in. On the rising edge of $\overline{WR}$ , the logic control input data is latched.
22	$\overline{EN}$	Active Low, Digital Input. When this pin is high, the device is disabled and all switches are off. When this pin is low, the Ax logic control inputs determine the on switches. The EN input signal is not latched by $\overline{WR}$ .
23	GND	Ground (0 V) Reference.
24	V <sub>SS</sub>	Most Negative Power Supply in a Dual-Supply Application. In single-supply applications, connect this pin to GND.
25 to 40 41, 42, 44	S17 to S32 NIC	Source Terminal. This pin may be an input or output. Not Internally Connected. Do not connect to this pin.
43	D EPAD	Drain Terminal. This pin may be an input or output. Exposed Pad. The exposed pad must be connected to GND.

**Truth Tables**

Table 10. ADG726 Truth Table

A3 <sup>1</sup>	A2 <sup>1</sup>	A1 <sup>1</sup>	A0 <sup>1</sup>	$\overline{EN}^1$	$\overline{CSA}$	$\overline{CSB}$	$\overline{WR}^1$	On Switch
X	X	X	X	X	1	1	L → H	Latches control input data
X	X	X	X	X	1	1	X	No change in switch condition
X	X	X	X	1	X	X	X	None
0	0	0	0	0	0	0	0	S1A to DA, S1B to DB
0	0	0	1	0	0	0	0	S2A to DA, S2B to DB
0	0	1	0	0	0	0	0	S3A to DA, S3B to DB
0	0	1	1	0	0	0	0	S4A to DA, S4B to DB
0	1	0	0	0	0	0	0	S5A to DA, S5B to DB
0	1	0	1	0	0	0	0	S6A to DA, S6B to DB
0	1	1	0	0	0	0	0	S7A to DA, S7B to DB
0	1	1	1	0	0	0	0	S8A to DA, S8B to DB
1	0	0	0	0	0	0	0	S9A to DA, S9B to DB
1	0	0	1	0	0	0	0	S10A to DA, S10B to DB
1	0	1	0	0	0	0	0	S11A to DA, S11B to DB
1	0	1	1	0	0	0	0	S12A to DA, S12B to DB

A3 <sup>1</sup>	A2 <sup>1</sup>	A1 <sup>1</sup>	A0 <sup>1</sup>	EN <sup>1</sup>	CSA	CSB	WR <sup>1</sup>	On Switch
1	1	0	0	0	0	0	0	S13A to DA, S13B to DB
1	1	0	1	0	0	0	0	S14A to DA, S14B to DB
1	1	1	0	0	0	0	0	S15A to DA, S15B to DB
1	1	1	1	0	0	0	0	S16A to DA, S16B to DB

<sup>1</sup> X is don't care, L is low, and H is high.

Table 11. ADG732 Truth Table

A4 <sup>1</sup>	A3 <sup>1</sup>	A2 <sup>1</sup>	A1 <sup>1</sup>	A0 <sup>1</sup>	EN <sup>1</sup>	CS	WR <sup>1</sup>	Switch Condition
X	X	X	X	X	X	1	L → H	Latches control input data
X	X	X	X	X	X	1	X	No change in switch condition
X	X	X	X	X	1	X	X	None
0	0	0	0	0	0	0	0	1
0	0	0	0	1	0	0	0	2
0	0	0	1	0	0	0	0	3
0	0	0	1	1	0	0	0	4
0	0	1	0	0	0	0	0	5
0	0	1	0	1	0	0	0	6
0	0	1	1	0	0	0	0	7
0	0	1	1	1	0	0	0	8
0	1	0	0	0	0	0	0	9
0	1	0	0	1	0	0	0	10
0	1	0	1	0	0	0	0	11
0	1	0	1	1	0	0	0	12
0	1	1	0	0	0	0	0	13
0	1	1	0	1	0	0	0	14
0	1	1	1	0	0	0	0	15
0	1	1	1	1	0	0	0	16
1	0	0	0	0	0	0	0	17
1	0	0	0	1	0	0	0	18
1	0	0	1	0	0	0	0	19
1	0	0	1	1	0	0	0	20
1	0	1	0	0	0	0	0	21
1	0	1	0	1	0	0	0	22
1	0	1	1	0	0	0	0	23
1	0	1	1	1	0	0	0	24
1	1	0	0	0	0	0	0	25
1	1	0	0	1	0	0	0	26
1	1	0	1	0	0	0	0	27
1	1	0	1	1	0	0	0	28
1	1	1	0	0	0	0	0	29
1	1	1	0	1	0	0	0	30
1	1	1	1	0	0	0	0	31
1	1	1	1	1	0	0	0	32

<sup>1</sup> X is don't care, L is low, and H is high.

TYPICAL PERFORMANCE CHARACTERISTICS

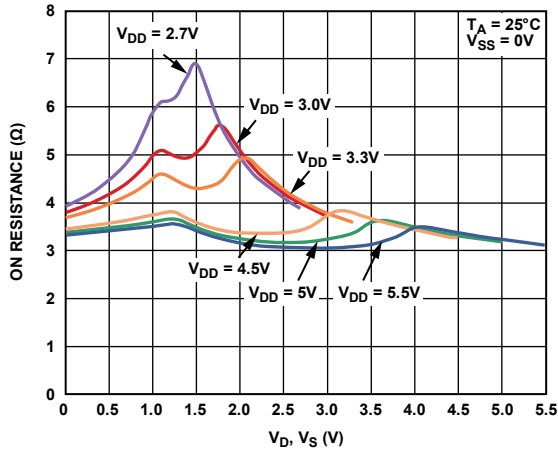

Figure 8. On Resistance vs.  $V_D$  ( $V_S$ ), Single Supply

02765-006

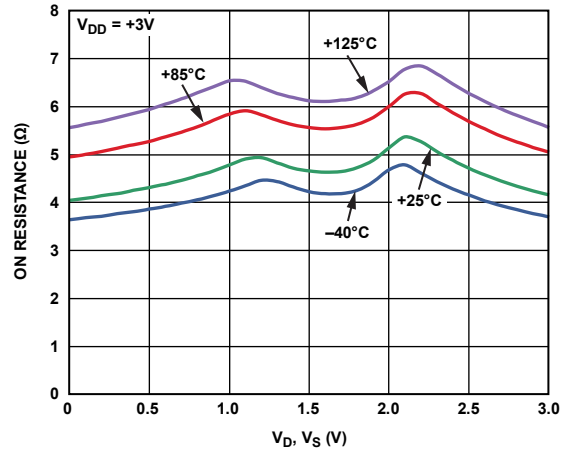

Figure 11. On Resistance vs.  $V_D$  ( $V_S$ ), Single Supply

02765-009

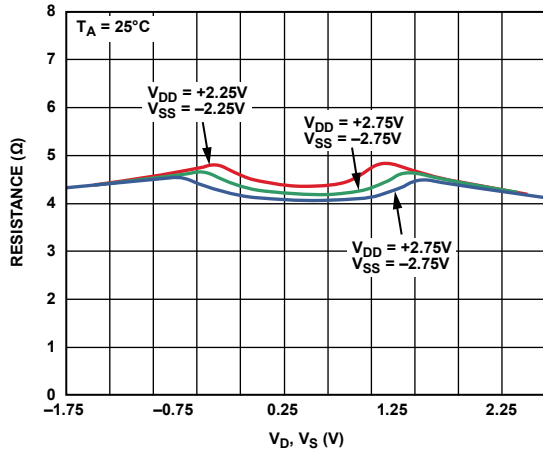

Figure 9. On Resistance vs.  $V_D$  ( $V_S$ ), Dual Supply

02765-007

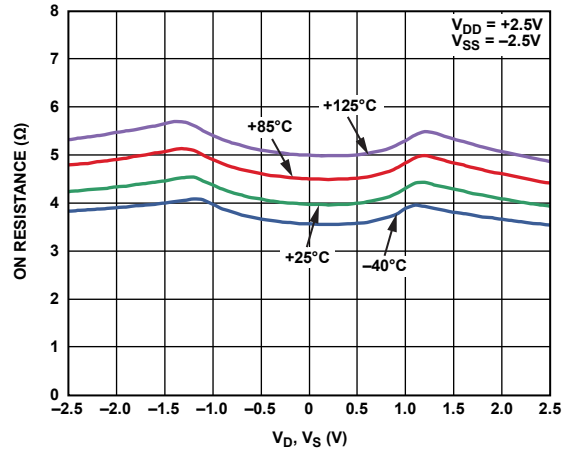

Figure 12. On Resistance vs.  $V_D$  ( $V_S$ ), Dual Supply

02765-010

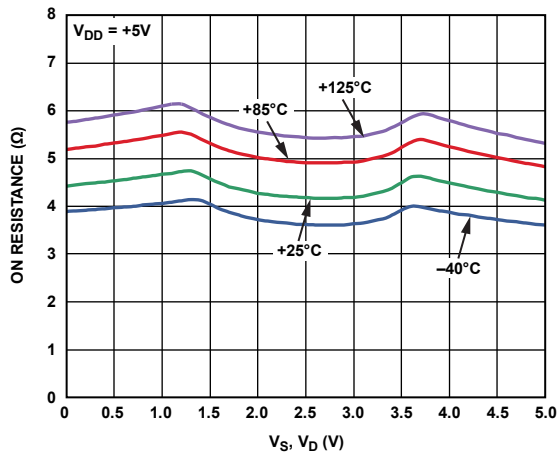

Figure 10. On Resistance vs.  $V_D$  ( $V_S$ ) for Different Temperatures, Single Supply

02765-008

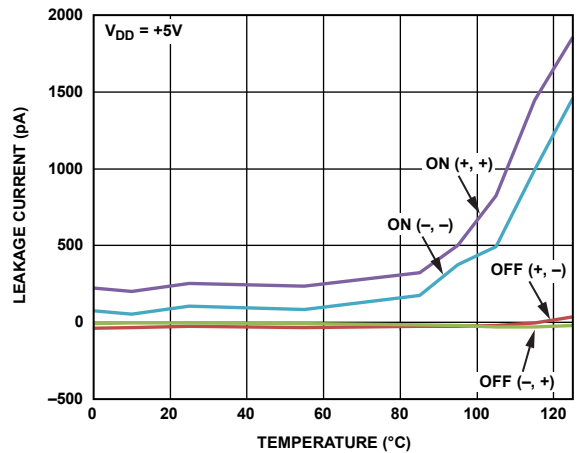

Figure 13. Leakage Currents vs. Temperature

02765-011

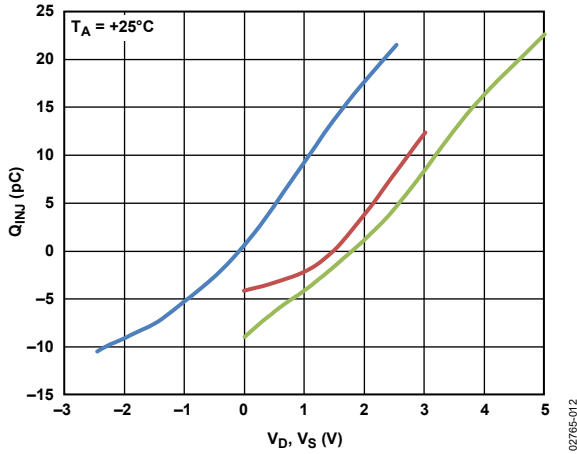

Figure 14. ADG732 Charge Injection ( $Q_{INJ}$ ) vs.  $V_D$ ,  $V_S$

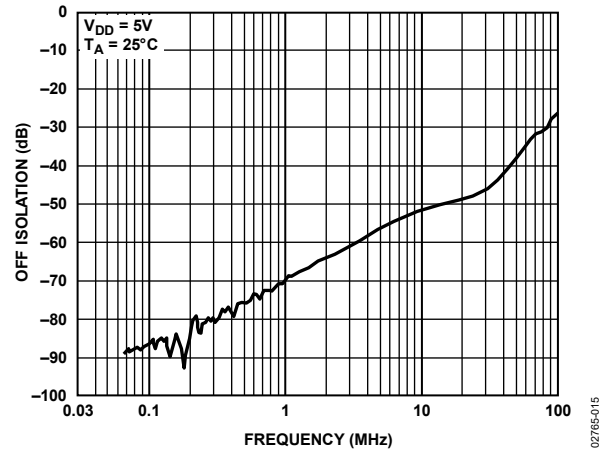

Figure 17. Off Isolation vs. Frequency

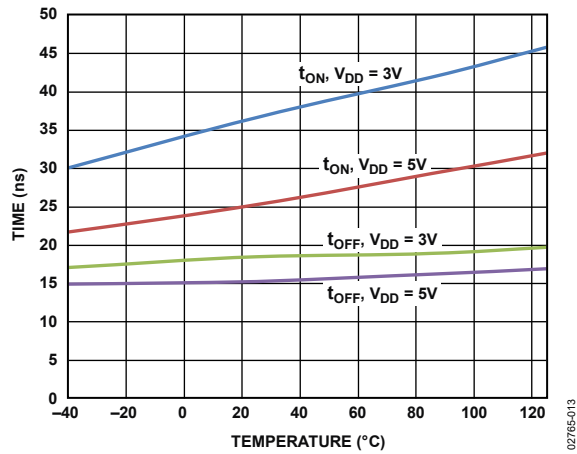

Figure 15.  $t_{ON}/t_{OFF}$  ( $\overline{EN}$ ) Time vs. Temperature

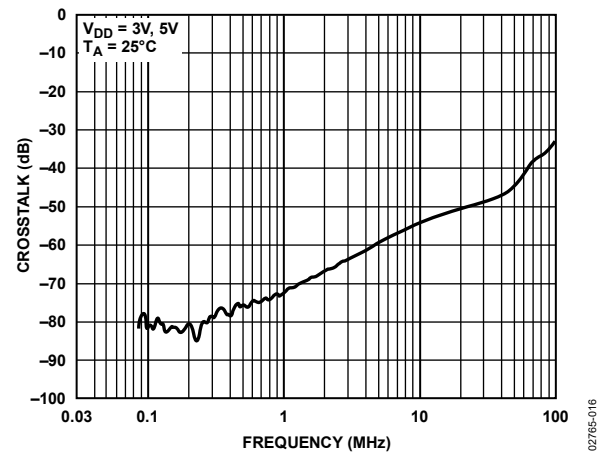

Figure 18. Crosstalk vs. Frequency

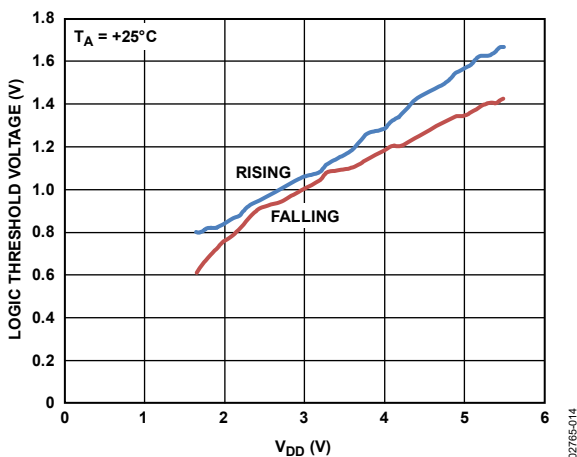

Figure 16. Logic Threshold Voltage vs. Supply Voltage ( $V_{DD}$ )

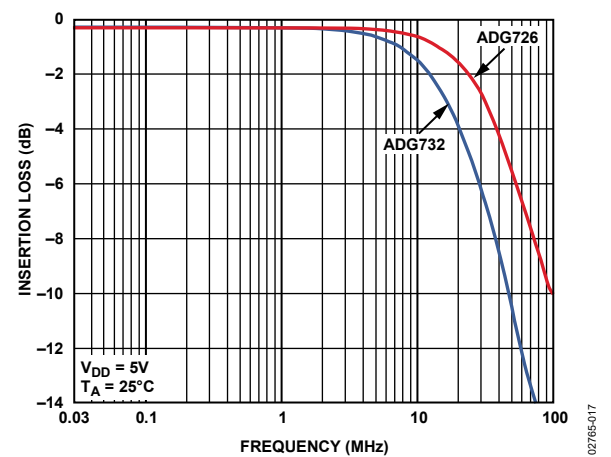

Figure 19. Insertion Loss vs. Frequency



TEST CIRCUITS

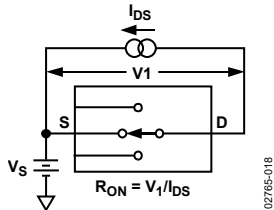

Figure 20. On Resistance

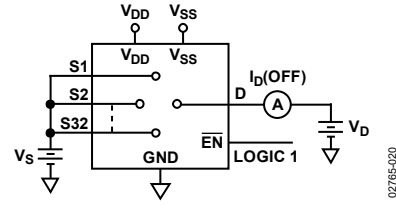

Figure 24. I<sub>b</sub> (Off)

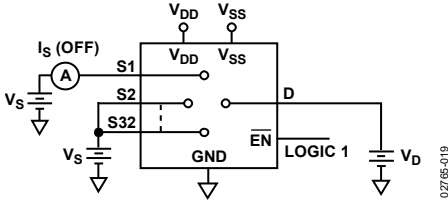

Figure 21. I<sub>s</sub> (Off)

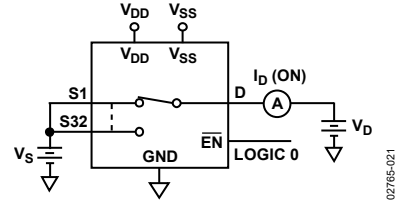
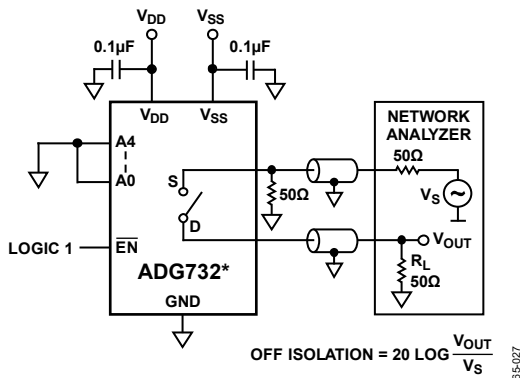
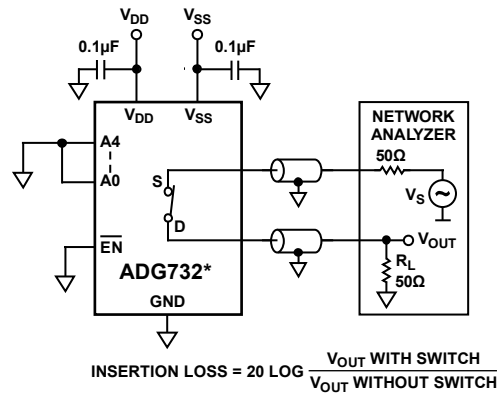

Figure 25. I<sub>b</sub> (On)



\*SIMILAR CONNECTION FOR ADG726.

Figure 22. Off Isolation



\*SIMILAR CONNECTION FOR ADG726.

Figure 26. Bandwidth

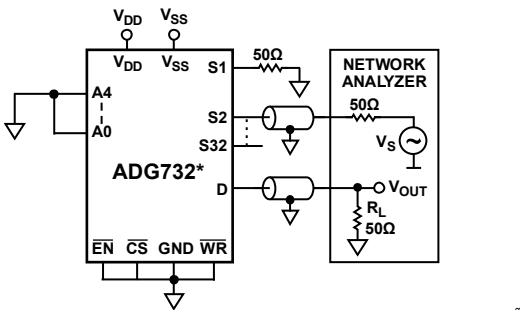

\*SIMILAR CONNECTION FOR ADG726.  
CHANNEL-TO-CHANNEL CROSSTALK = 20LOG<sub>10</sub> (V<sub>OUT</sub>/V<sub>S</sub>)

Figure 23. Channel-to-Channel Crosstalk

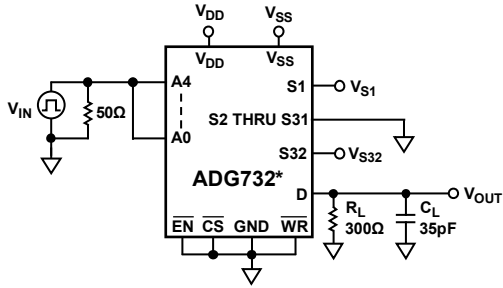

\*SIMILAR CONNECTION FOR ADG726.

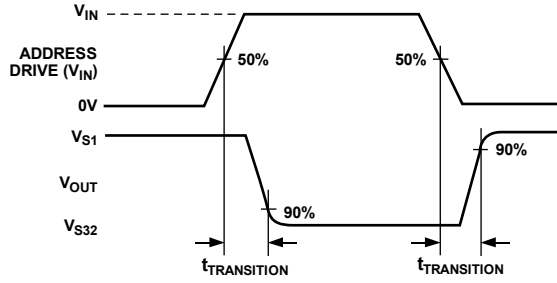

02765-022

Figure 27. Switching Time of Multiplexer,  $t_{TRANSITION}$

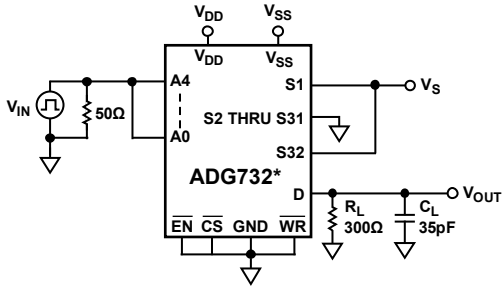

\*SIMILAR CONNECTION FOR ADG726.

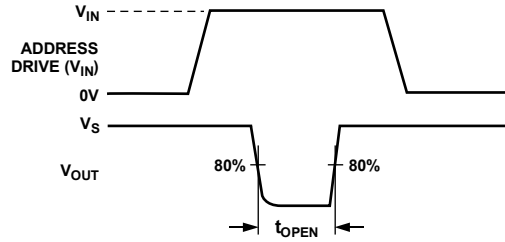

02765-023

Figure 28. Break-Before-Make Delay,  $t_{OPEN}$

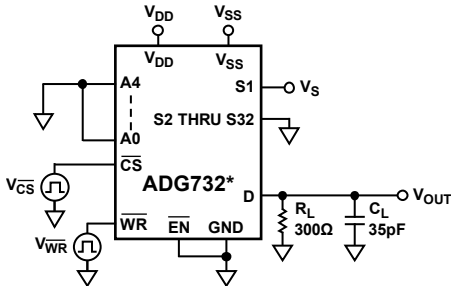

\*SIMILAR CONNECTION FOR ADG726.

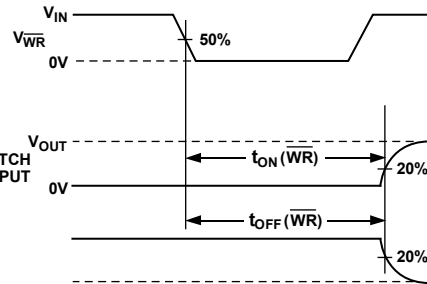

02765-024

Figure 29. Write Turn-On and Turn-Off Time,  $t_{ON}$ ,  $t_{OFF}(\overline{WR})$

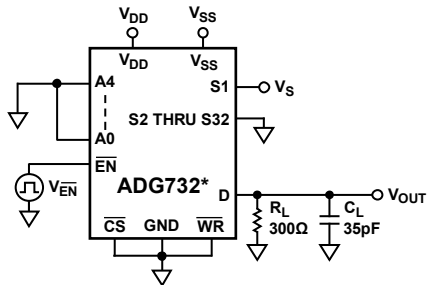

\*SIMILAR CONNECTION FOR ADG726.

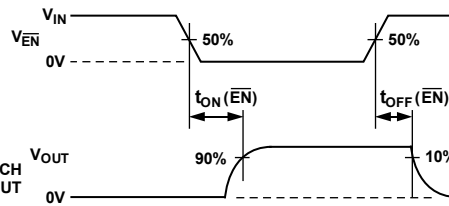

02765-025

Figure 30. Enable Delay,  $t_{ON}(\overline{EN})$ ,  $t_{OFF}(\overline{EN})$

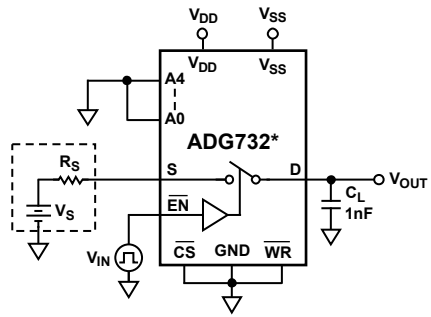

\*SIMILAR CONNECTION FOR ADG726.

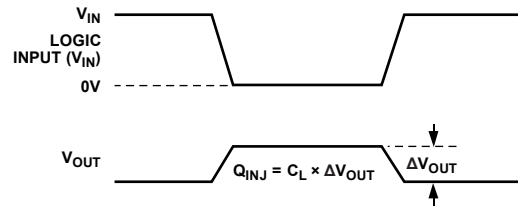

Figure 31. Charge Injection

02785-028

## TERMINOLOGY

### $I_{DD}$

$I_{DD}$  represents the positive supply current.

### $I_{SS}$

$I_{SS}$  represents the negative supply current.

### IN

IN represents the logic control input.

### $V_D$ ( $V_S$ )

$V_D$  and  $V_S$  represent the analog voltage on the Dx pins and the Sx pins, respectively.

### $R_{ON}$

$R_{ON}$  represents the ohmic resistance between the Dx pins and the Sx pins.

### $\Delta R_{ON}$

$\Delta R_{ON}$  represents the difference between the  $R_{ON}$  of any two channels.

### $R_{FLAT(ON)}$

$R_{FLAT(ON)}$  is the flatness that is defined as the difference between the maximum and minimum value of on resistance measured over the specified analog signal range.

### $I_S$ (Off)

$I_S$  (Off) represents the source leakage current with the switch off.

### $I_D$ (Off)

$I_D$  (Off) represents the drain leakage current with the switch off.

### $I_D$ (On), $I_S$ (On)

$I_D$  (On) and  $I_S$  (On) represent the channel leakage currents with the switch on.

### $V_{INL}$

$V_{INL}$  is the maximum input voltage for Logic 0.

### $V_{INH}$

$V_{INH}$  is the minimum input voltage for Logic 1.

### $I_{INL}$ , $I_{INH}$

$I_{INL}$  and  $I_{INH}$  represent the low and high input currents of the digital inputs.

### $C_S$ (Off)

$C_S$  (Off) represents the off switch source capacitance. It is measured with a reference to ground.

### $C_D$ (Off)

$C_D$  (Off) represents the off switch drain capacitance. It is measured with reference to ground.

### $C_D$ (On), $C_S$ (On)

$C_D$  (On) and  $C_S$  (On) represent the on switch capacitances, which are measured with reference to ground.

### $C_{IN}$

$C_{IN}$  is the digital input capacitance.

### $t_{TRANSITION}$

$t_{TRANSITION}$  is the delay time measured between the 50% and 90% points of the digital inputs and the switch on condition when switching from one address state to another.

### $t_{ON}$ ( $\overline{EN}$ )

$t_{ON}$  ( $\overline{EN}$ ) is the delay time between the 50% and 90% points of the  $\overline{EN}$  digital input and the switch on condition.

### $t_{OFF}$ ( $\overline{EN}$ )

$t_{OFF}$  ( $\overline{EN}$ ) is the delay time between the 50% and 90% points of the  $\overline{EN}$  digital input and the switch off condition.

### $t_{OPEN}$

$t_{OPEN}$  is the off time measured between the 80% points of both switches when switching from one address state to another

### Charge Injection

Charge injection is a measure of the glitch impulse transferred from the digital input to the analog output during switching.

### Off Isolation

Off isolation is a measure of the unwanted signal coupling through an off switch.

### Channel-to-Channel Crosstalk

Crosstalk is a measure of unwanted signal that is coupled through from one channel to another as a result of parasitic capacitance.

### Insertion Loss

Insertion loss is the loss due to the on resistance of the switch.

OUTLINE DIMENSIONS

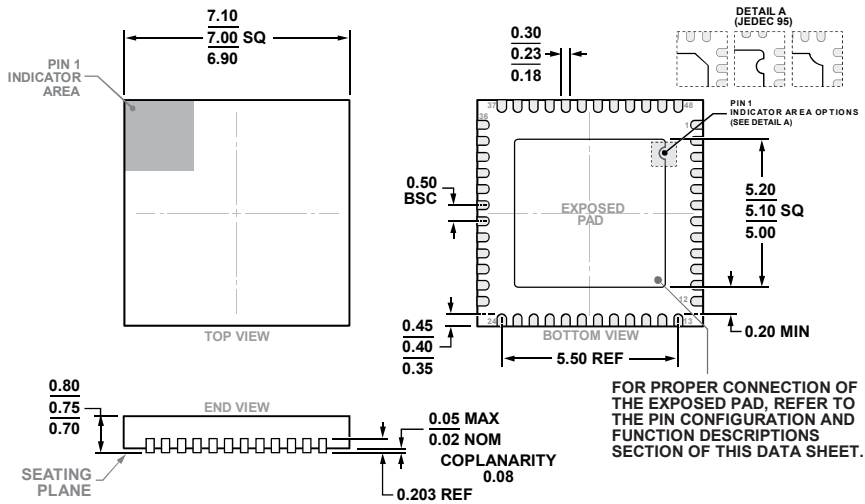

COMPLIANT TO JEDEC STANDARDS MO-220-WKGD-4

Figure 32. 48-Lead Frame Chip Scale Package [LFCSP]  
7 mm × 7 mm Body and 0.75 mm Package Height  
(CP-48-4)

Dimensions shown in millimeters

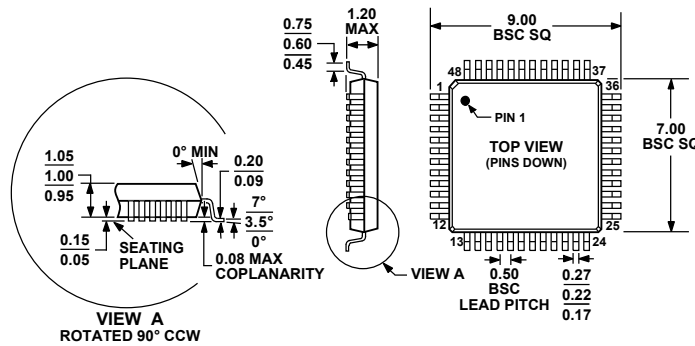

COMPLIANT TO JEDEC STANDARDS MS-026ABC

Figure 33. 48-Lead Thin Plastic Quad Flat Package [TQFP]  
(SU-48)

Dimensions shown in millimeters

ORDERING GUIDE

Model <sup>1</sup>	Temperature Range	Package Description	Package Option
ADG726BCPZ	-40°C to +85°C	48-Lead Frame Chip Scale Package [LFCSP]	CP-48-4
ADG726BCPZ-REEL	-40°C to +85°C	48-Lead Frame Chip Scale Package [LFCSP]	CP-48-4
ADG726BSUZ	-40°C to +85°C	48-Lead Thin Plastic Quad Flat Package [TQFP]	SU-48
ADG726BSUZ-REEL	-40°C to +85°C	48-Lead Thin Plastic Quad Flat Package [TQFP]	SU-48
ADG732BCPZ	-40°C to +125°C	48-Lead Frame Chip Scale Package [LFCSP]	CP-48-4
ADG732BCPZ-REEL	-40°C to +125°C	48-Lead Frame Chip Scale Package [LFCSP]	CP-48-4
ADG732BSUZ	-40°C to +125°C	48-Lead Thin Plastic Quad Flat Package [TQFP]	SU-48
ADG732BSUZ-REEL	-40°C to +125°C	48-Lead Thin Plastic Quad Flat Package [TQFP]	SU-48

<sup>1</sup> Z = RoHS-Compliant Part

# Mouser Electronics

Authorized Distributor

Click to View Pricing, Inventory, Delivery & Lifecycle Information:

[Analog Devices Inc.:](#)

[ADG732BCPZ](#) [ADG732BSUZ-REEL](#) [ADG732BSUZ](#) [ADG732BCPZ-REEL](#)