

SMD/BLOCK Type EMI Suppression Filters EMIFIL[®]





EU RoHS Compliant

- All the products in this catalog comply with EU RoHS.
- EU RoHS is "the European Directive 2011/65/EU on the Restriction of the Use of Certain Hazardous Substances in Electrical and Electronic Equipment."
- For more details, please refer to our web page, "Murata's Approach for EU RoHS" (<http://www.murata.com/en-eu/support/compliance/rohs>).

Contents

Product specifications are as of September 2018.

Selection Guide for Noise Suppression Filters	p2
EMI Filter Selection by Application	p4
• Digital Still Camera	p4
• Smartphone	p5
• Blu-ray/DVD	p6
• LCD-TV	p7
EMI Filter Selection by Circuits and Noise Frequency	p8
Product Guide	p10

Chip Ferrite Bead BLM/BLA/BLT Series

Series Introduction	p16
Part Numbering	p18
Series Lineup	p19
Product Detail	p26
⚠Caution/Notice	p110
Soldering and Mounting	p111
Packaging	p115

Application Specified Noise Filter NFZ_S/NFZ_B/BLF/BLE/LQW_CA Series

Part Numbering	p118
Series Lineup	p122
Product Detail	
Noise filter for audio lines	p126
Noise filter for LED lighting equipment	p133
Frequency specified noise filter	p142
Noise filter for power charger lines	p145
Inductor for audio line noise suppression	p147
⚠Caution/Notice	p151
Soldering and Mounting	p154
Packaging	p160

Chip EMIFIL® NFL/NFA/NFW/NFE Series

Series Introduction	p166
Part Numbering	p168
Series Lineup	p170
Product Detail	p172
⚠Caution/Notice	p185
Soldering and Mounting	p186
Packaging	p190

Common Mode Choke Coil · Common Mode Noise Filter DLM/DLP/DLW/NFP/PLT Series

Series Introduction	p192
Part Numbering	p194
Series Lineup	p198
Product Detail	p202
⚠Caution/Notice	p240
Soldering and Mounting	p243
Packaging	p250

Block Type EMIFIL® BNX Series

Series Lineup/Function Example	p254
Product Detail	p256
⚠Caution/Notice	p260
Soldering and Mounting	p262
Packaging	p266

EMC Absorber EA20/EA21 Series



Part Numbering	p268
Product Detail	p269
Notice	p270

Part Number Quick Reference	p271
Introduction of Related Catalogs	p272
Noise Suppression Basic Course	p273

Please check the MURATA website (<https://www.murata.com/>) if you cannot find a part number in this catalog.

Selection Guide for Noise Suppression Filters

Features & Suitable Circuits

Type Representative series name	Features	Suitable Circuits
Ferrite Bead BLM/BLA Series 	<ul style="list-style-type: none"> · Miniaturized · GND connection unnecessary · Effective at low impedance line 	<ul style="list-style-type: none"> · Application set with less noise radiation · Low impedance line
Capacitor Type NFM/NFA/NFE/ NFL/NFW Series 	<ul style="list-style-type: none"> · Great noise suppression effect · With effect as bypass capacitor (Lineup for Power) · Good noise separation from signal (LC filter for Signal) · Effective at high impedance line 	<ul style="list-style-type: none"> · Application set with higher noise radiation · High impedance line · Circuit with bypass capacitor · Circuit driven by high frequency
Common Mode Choke Coil DLW/DLM/DLP Series 	<ul style="list-style-type: none"> · Possible to suppress noise with less affect of ultra-high-speed signal · Significant improvement in common mode noise · Less magnetic saturation by current 	<ul style="list-style-type: none"> · High-speed differential signal line · I/F cable driver · Power line

Example

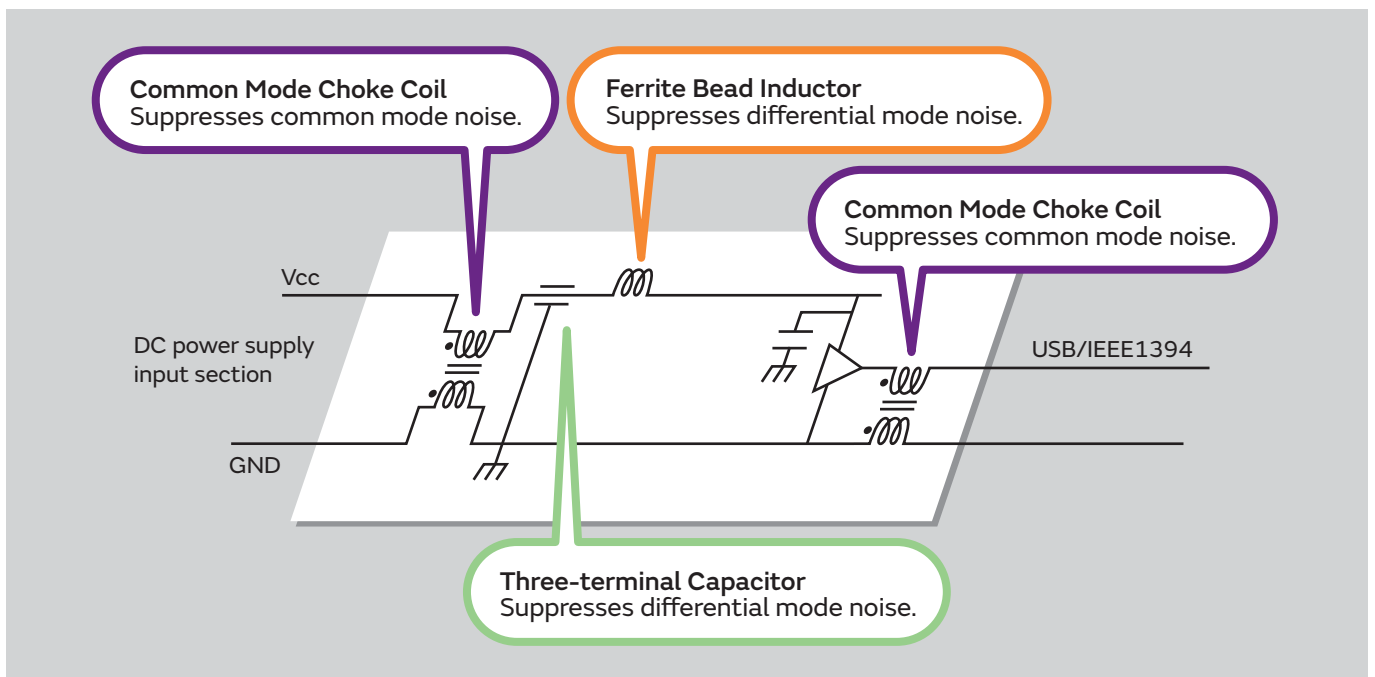

Selection Guide for Noise Suppression Filters

Advantages to Using Common Mode Choke Coils

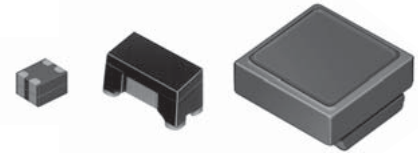

1. Great Effect for Common Mode Noise

Differential mode inductors work as a half impedance for common mode noise. Common Mode Choke Coils are effective for common mode noise.

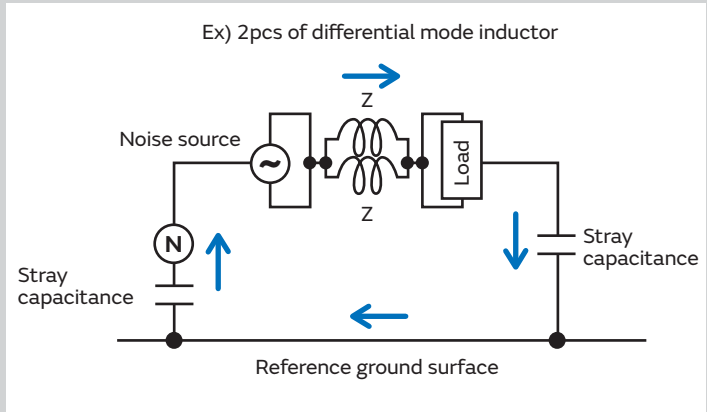

2. Possible to Suppress Noise with Less Effect on the Ultra-High-Speed Signal

Common Mode Choke Coils can suppress Noise with less effect on the Signal, even if the frequency range of Signal and Noise are the same, because they separate each conductive mode of current.

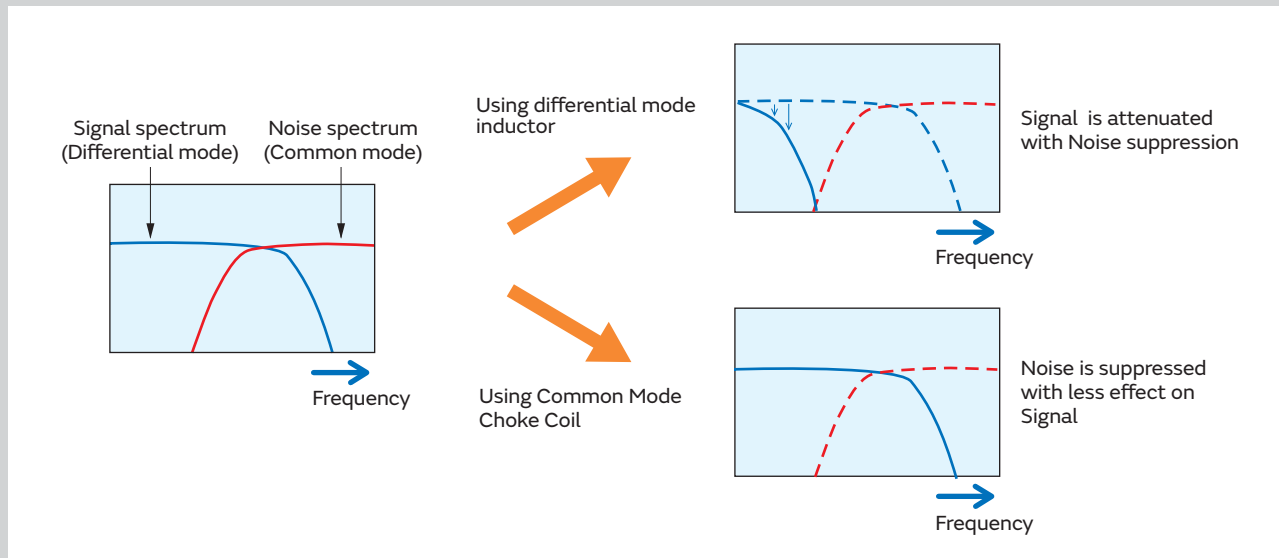

3. Less Magnetic Saturation by Current

Common Mode Choke Coils are effective for noise suppression of DC power lines, due to their less magnetic saturation at high power current, which comes from their construction of cancelling magnetic flux of the differential mode current at each coil.

EMI Filter Selection by Application

Digital Still Camera Application Sample

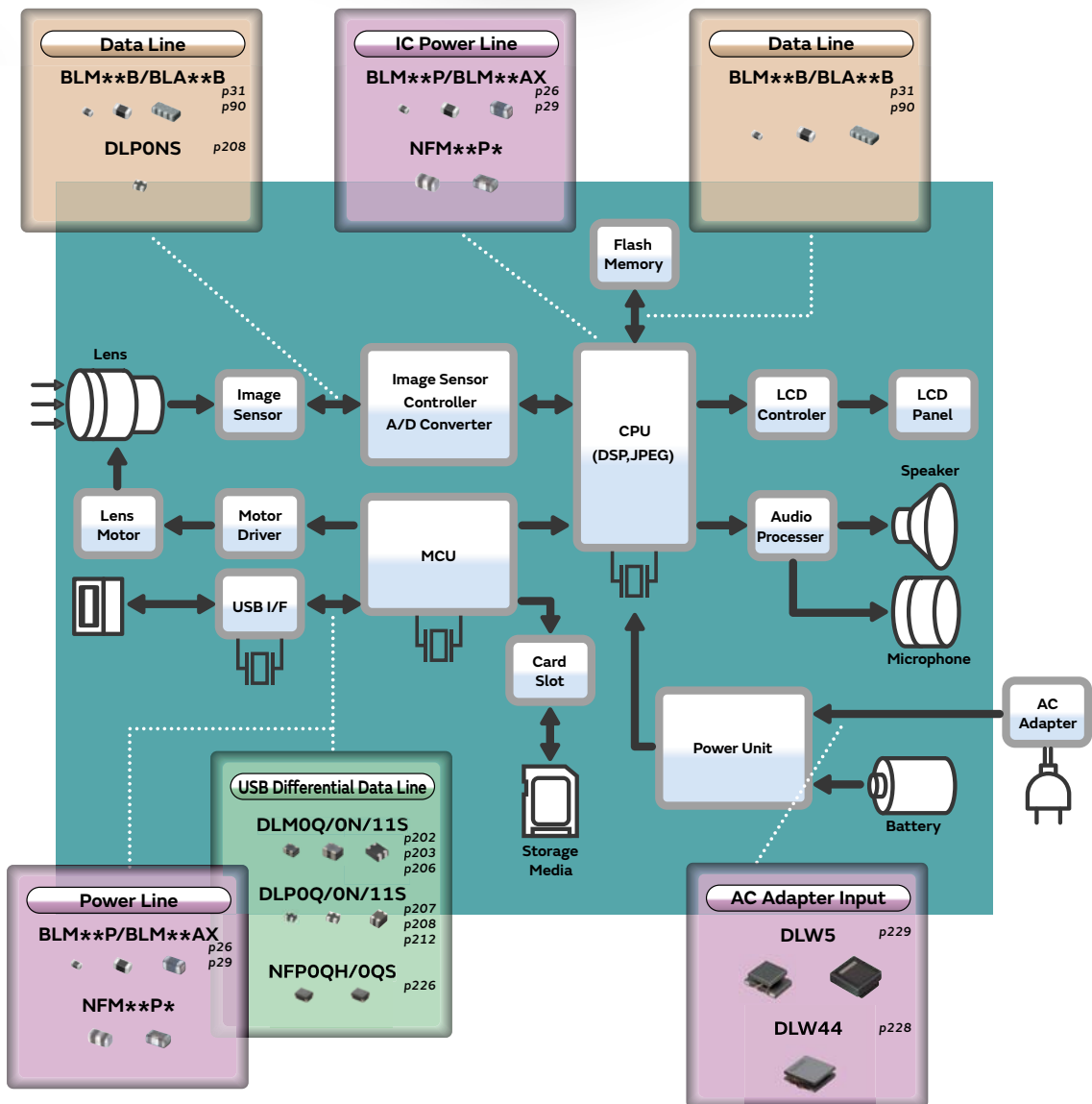

EMI Filter Selection by Application

Smartphone Application Sample

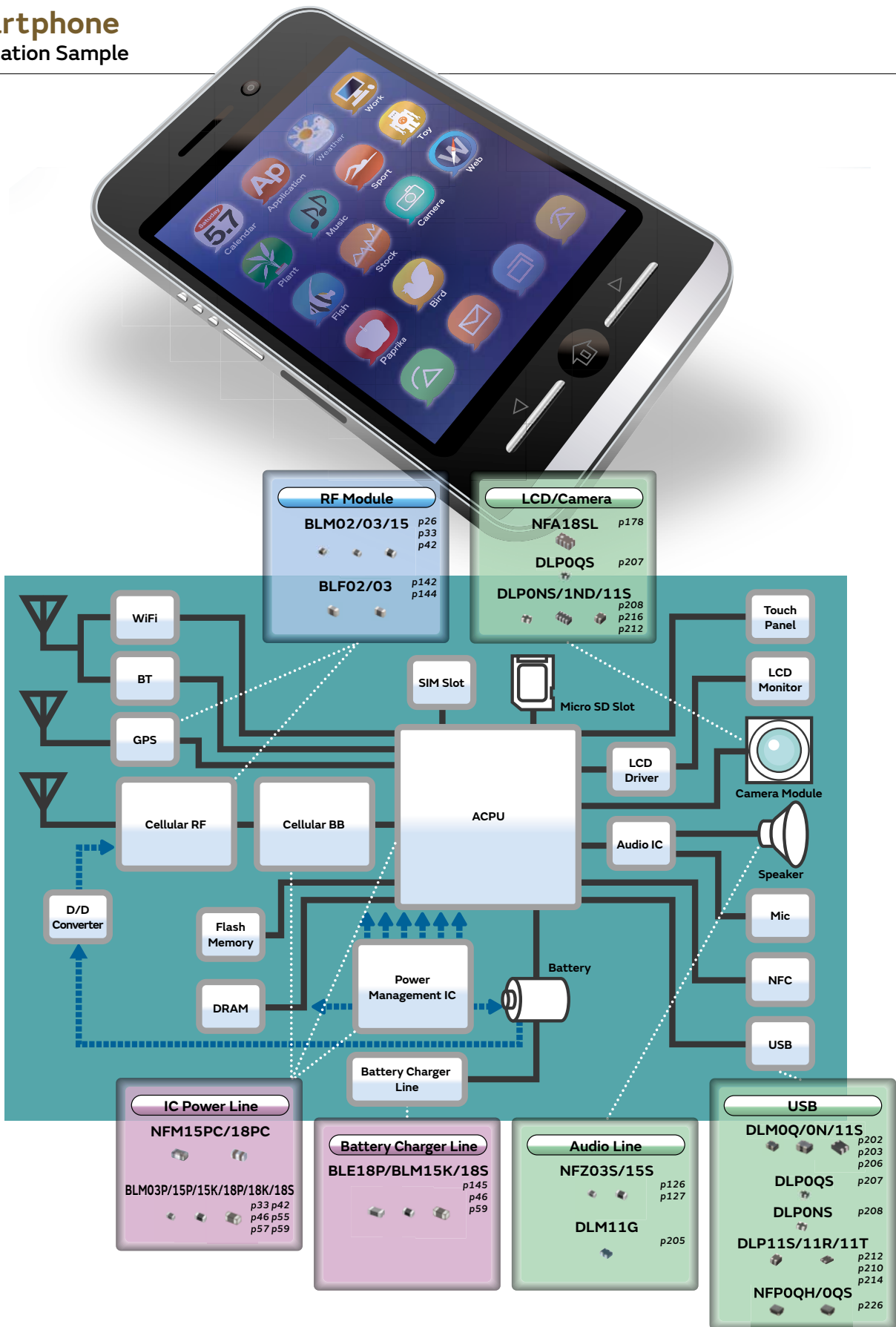

EMI Filter Selection by Application

Blu-ray/DVD Application Sample

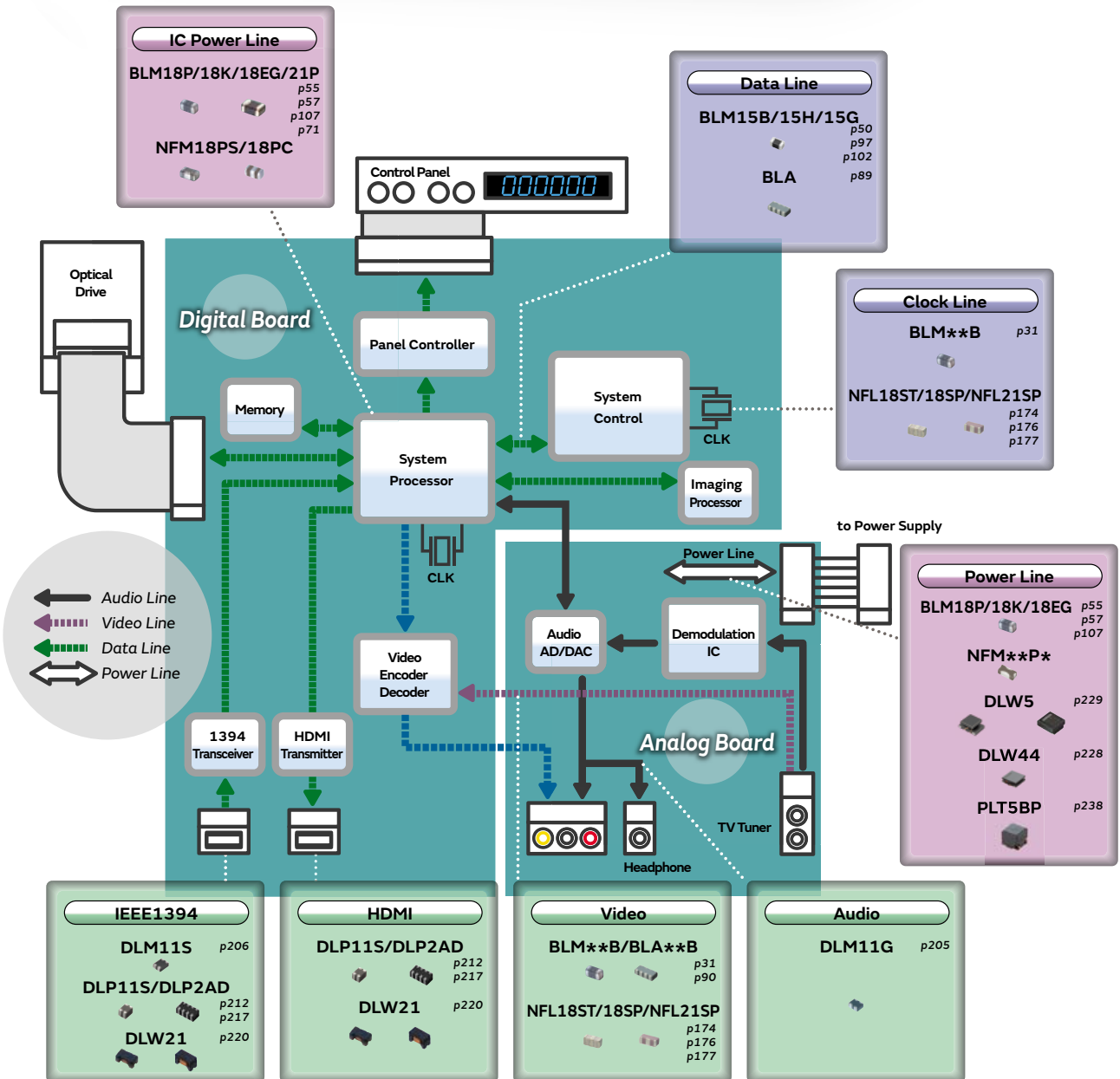

EMI Filter Selection by Application

LCD-TV Application Sample

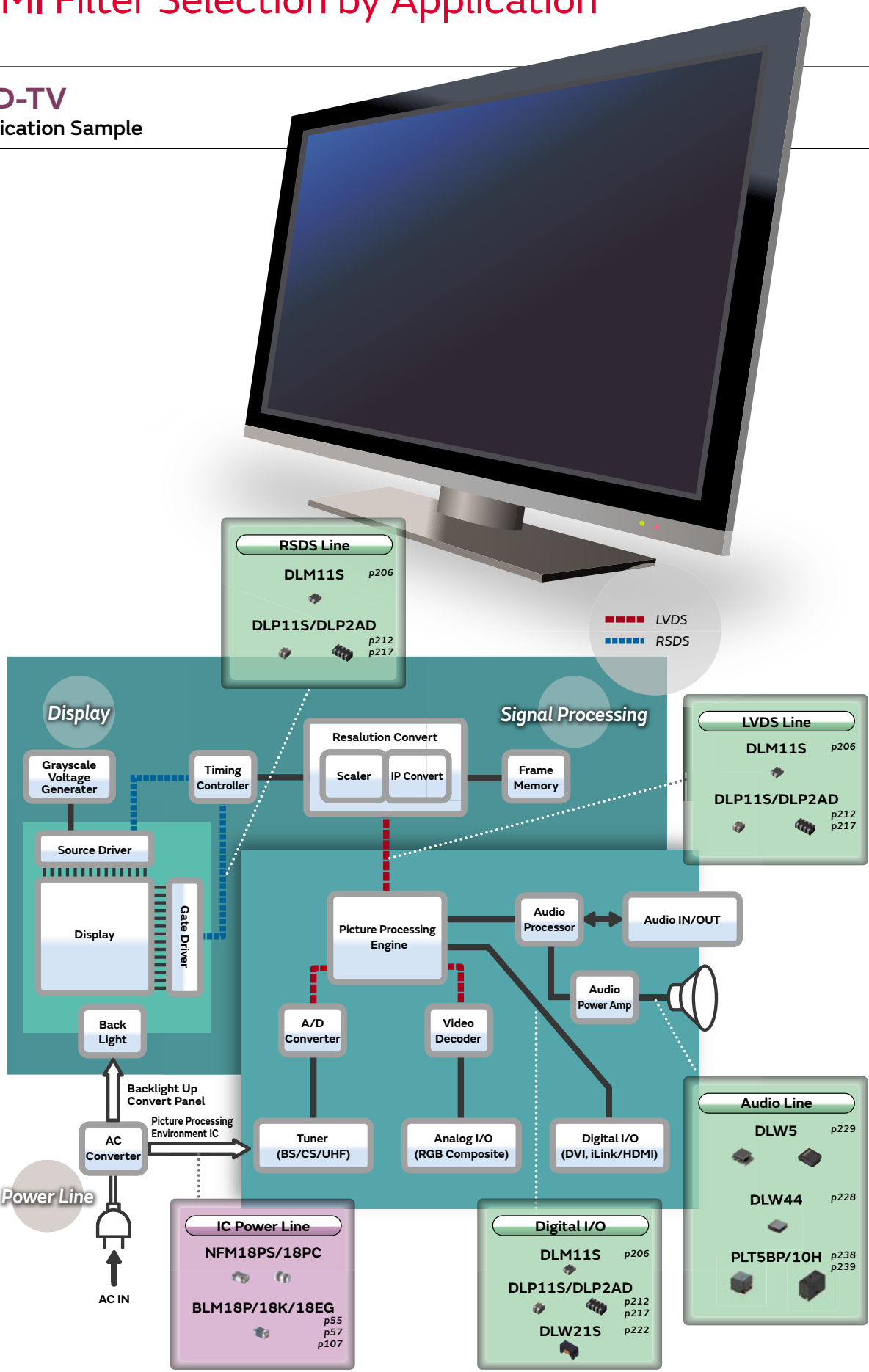

EMI Filter Selection by Circuits and Noise Frequency

Chip Ferrite Bead / Chip EMIFIL[®]

		Circuit Type				
		Power Line	General Signal Line Under 10MHz	High-Speed Signal Line Over 10MHz		
Noise Frequency	Noise Frequency: Under 1GHz	Inductor Type (Suppression Effect: Normal)	<ul style="list-style-type: none"> BLF02JD 01005(0402) p142 BLM02AX 01005(0402) p29 BLF03JD 0201(0603) p144 BLM03AX 0201(0603) p38 	<ul style="list-style-type: none"> BLM02BX/BC/BB 01005(0402) p31 BLM03B 0201(0603) p39 BLM15BX 0402(1005) p53 BLM15B 0402(1005) p50 BLM18B 0603(1608) p65 BLM21B 0805(2012) p77 		
			<ul style="list-style-type: none"> BLM03PG 0201(0603) p33 	<ul style="list-style-type: none"> BLM03AG 0201(0603) p36 BLM15AG 0402(1005) p47 BLM18A 0603(1608) p62 		
			Low DC Resistance / High Current Type			
			<ul style="list-style-type: none"> BLM02PX 01005(0402) p26 BLM02KX 01005(0402) p28 BLM03PX 0201(0603) p34 			
				BLM15AX 0402(1005) p48		
			<ul style="list-style-type: none"> BLM15PX 0402(1005) p44 BLM15P 0402(1005) p42 BLM15KD 0402(1005) p46 BLM18P 0603(1608) p55 BLE18P 0603(1608) p145 BLM21P 0805(2012) p71 BLM31P 1206(3216) p83 BLE32P 1210(3225) p146 BLM41P 1806(4516) p86 	<ul style="list-style-type: none"> BLM18T 0603(1608) p64 BLM18R 0603(1608) p69 BLM21A 0805(2012) p75 BLM21R 0805(2012) p80 		
				Array Type		
				<ul style="list-style-type: none"> BLA2AA 0804(2010) p89 BLA31A 1206(3216) p92 	<ul style="list-style-type: none"> BLA2AB 0804(2010) p90 BLA31B 1206(3216) p93 	
				Low DC Resistance Type		
			<ul style="list-style-type: none"> BLM18K 0603(1608) p57 BLM18S 0603(1608) p59 BLM21S 0805(2012) p73 BLM31S 1206(3216) p85 BLM31KN 1206(3216) p81 BLT5BPT 2020(5050) p88 			
Noise Frequency	Noise Frequency: GHz Band (800MHz to 2.5GHz)	Capacitor Type (Suppression Effect: High)	T Circuit Filter Feed-Through Type			
			<ul style="list-style-type: none"> NFE31PT 1206(3216) p172 NFE61PT 2706(6816) p173 	LC Combined		
			Block Type			
			<ul style="list-style-type: none"> BNX022/023/028/029 p256 		<ul style="list-style-type: none"> NFL18ST 0603(1608) p174 NFL18SP 0603(1608) p176 NFL21SP 0805(2012) p177 NFW31SP 1206(3216) p184 	
					Array Type (LC Combined)	
					<ul style="list-style-type: none"> NFA18SL/SD 0603(1608) p178 NFA21SL 0805(2012) p182 	
			Inductor Type (Suppression Effect: Normal)	<ul style="list-style-type: none"> BLF02RD 01005(0402) p143 BLM18HE 0603(1608) p103 	<ul style="list-style-type: none"> BLM03HG 0201(0603) p94 BLM15HG 0402(1005) p97 BLM18HG 0603(1608) p103 BLM18HK 0603(1608) p103 	<ul style="list-style-type: none"> BLM03HD 0201(0603) p94 BLM03HB 0201(0603) p94 BLM15HD 0402(1005) p97 BLM15HB 0402(1005) p97 BLM18HD 0603(1608) p103 BLM18HE 0603(1608) p103 BLM18HB 0603(1608) p103
				<ul style="list-style-type: none"> BLM03E 0201(0603) p96 BLM15E 0402(1005) p99 BLM18E 0603(1608) p107 		
						LC Combined
			Capacitor Type (Suppression Effect: High)			<ul style="list-style-type: none"> NFL18ST 0603(1608) p174
		Array Type (LC Combined)				
		<ul style="list-style-type: none"> NFA18SL/SD 0603(1608) p178 NFA21SL 0805(2012) p182 				
Inductor Type	Noise Frequency: High-GHz Band (1GHz to 10GHz)		<ul style="list-style-type: none"> BLM15GG 0402(1005) p102 BLM18G 0603(1608) p109 	<ul style="list-style-type: none"> BLM15GA 0402(1005) p102 		

Noise Filter for Audio Line

		Circuit Type	
		Noise Filter For Audio Line	
		Earphone	Speaker
Noise Frequency	Noise Frequency: Under 1GHz		NFZ18SM_10 0603(1608) <small>p129</small> NFZ2MSM_10 0806(2016) <small>p131</small> NFZ32SW_10 1210(3225) <small>p132</small>
	Noise Frequency: Over 1GHz	NFZ03SG_10 0201(0603) <small>p126</small> NFZ15SG_10 0402(1005) <small>p127</small>	NFZ15SG_11 0402(1005) <small>p127</small>

Noise Filter for LED Line

		Circuit Type
		Noise Filter For LED Lighting Equipment
Noise Frequency	Noise Frequency: Under 1MHz	NFZ2HBM_10 1008(2520) <small>p133</small> NFZ32BW_11 1210(3225) <small>p135</small> NFZ32BW_10 1210(3225) <small>p135</small> NFZ5BBW_10 2020(5050) <small>p139</small>

Chip Common Mode Choke Coils

Circuit Type				
DC Power Line	High Speed Differential Signal Line		Audio Line	
	High-Speed Signal Line (USB2.0/LVDS/IEEE1394/mipi etc.)	Ultra-High-Speed Differential Signal Line (HDMI/DVI/Display Port/USB3.0 etc.)		
DLW44S 1515(4040) <small>p228</small> DLW5AH 2014(5036) <small>p229</small> DLW5AT 2014(5036) <small>p231</small> DLW5BS 2020(5050) <small>p229</small> DLW5BT 2020(5050) <small>p236</small> High Current Type PLT10HH 12.9mm×6.6mm <small>p239</small> PLT5BPH 2020(5050) <small>p238</small>	DLM0QSN 025020(0605) <small>p202</small> DLM0NSN 03025(0806) <small>p203</small> DLM11S 0504(1210) <small>p206</small> DLP0NSC 03025(0806) <small>p208</small> DLP0NSN 03025(0806) <small>p208</small> DLP11SN 0504(1210) <small>p212</small> DLP11RN 0504(1210) <small>p210</small> DLW21H 0805(2012) <small>p220</small> DLW21S_S 0805(2012) <small>p222</small> DLW21S_X 0805(2012) <small>p222</small> DLP31S 1206(3216) <small>p215</small> DLW31S 1206(3216) <small>p225</small>	NFPOQHB 025020(0605) <small>p226</small> NFPOQSB 025020(0605) <small>p226</small> DLMOQSB 025020(0605) <small>p202</small> DLPOQSA 025020(0605) <small>p207</small> DLMONSB 03025(0806) <small>p203</small> DLP0NSA 03025(0806) <small>p208</small> DLP11SA 0504(1210) <small>p212</small> DLP11RB 0504(1210) <small>p210</small> DLP11TB 0504(1210) <small>p214</small> DLW21S_HQ 0805(2012) <small>p222</small>	DLM11G 0504(1210) <small>p205</small> DLW5AT 2014(5036) <small>p231</small> DLW5BT 2020(5050) <small>p236</small>	
		Array Type DLP1ND 05025(1506) <small>p216</small> DLP2ADN 0804(2010) <small>p217</small> DLP31D 1206(3216) <small>p219</small>	Array Type DLP2ADA 0804(2010) <small>p217</small>	

Product Guide

BLM/BLA/BLT

Chip Ferrite Bead

Part Number	Size Code in inches (mm)	Impedance		Rated Current	
		at 100MHz	at 1GHz		
BLM02PX*	p26	01005 (0402)	10Ω to 60Ω	-	500mA to 1.1A
BLM02KX*	p28	01005 (0402)	10Ω to 18Ω	-	1.2A to 1.5A
BLM02AX	p29	01005 (0402)	10Ω to 240Ω	-	200mA to 750mA
BLM02BB/BC	p31	01005 (0402)	10Ω to 100Ω	95Ω to 240Ω	125mA to 250mA
BLM02BX*	p32	01005 (0402)	120Ω to 240Ω	-	240mA to 350mA
BLM03PG	p33	0201 (0603)	22Ω to 33Ω	-	750mA to 900mA
BLM03PX*	p34	0201 (0603)	22Ω to 120Ω	-	900mA to 1.8A
BLM03AG	p36	0201 (0603)	10Ω to 1000Ω	-	100mA to 500mA
BLM03AX	p38	0201 (0603)	10Ω to 1000Ω	-	200mA to 1A
BLM03BB/BC/BD	p39	0201 (0603)	10Ω to 600Ω	-	100mA to 300mA
BLM03BX	p41	0201 (0603)	1000Ω to 1800Ω	-	140mA to 170mA
BLM15PD*/PG	p42	0402 (1005)	10Ω to 120Ω	-	1A to 2.2A
BLM15PX*	p44	0402 (1005)	33Ω to 600Ω	-	900mA to 3A
BLM15KD*	p46	0402 (1005)	20Ω to 120Ω	-	1.5A to 3.8A
BLM15AG	p47	0402 (1005)	10Ω to 1000Ω	-	300mA to 1A
BLM15AX	p48	0402 (1005)	10Ω to 1000Ω	-	350mA to 1.74A
BLM15BA/BB/BC/BD	p50	0402 (1005)	5Ω to 1800Ω	-	100mA to 500mA
BLM15BX	p53	0402 (1005)	75Ω to 1800Ω	-	250mA to 600mA
BLM18PG*	p55	0603 (1608)	30Ω to 470Ω	-	1A to 3A
BLM18KG*	p57	0603 (1608)	26Ω to 1000Ω	-	1A to 6A
BLM18SD*/SG*/SN*	p59	0603 (1608)	22Ω to 330Ω	-	1.5A to 8A
BLM18AG	p62	0603 (1608)	120Ω to 1000Ω	-	450mA to 800mA
BLM18TG	p64	0603 (1608)	120Ω to 1000Ω	-	100mA to 200mA
BLM18BA/BB/BD	p65	0603 (1608)	5Ω to 2500Ω	-	150mA to 800mA
BLM18RK	p69	0603 (1608)	120Ω to 1000Ω	-	200mA
BLM21PG*	p71	0805 (2012)	22Ω to 330Ω	-	1.5A to 6A
BLM21SN*/SP*	p73	0805 (2012)	30Ω to 1000Ω	-	1.6A to 8.5A
BLM21AG	p75	0805 (2012)	120Ω to 1000Ω	-	600mA to 1A
BLM21BB/BD	p77	0805 (2012)	5Ω to 2700Ω	-	200mA to 1A
BLM21RK	p80	0805 (2012)	120Ω to 1000Ω	-	200mA
BLM31KN*	p81	1206 (3216)	120Ω to 1000Ω	-	2A to 6A
BLM31PG*	p83	1206 (3216)	33Ω to 600Ω	-	1.5A to 6A
BLM31SN*	p85	1206 (3216)	50Ω	-	12A
BLM41PG*	p86	1806 (4516)	60Ω to 1000Ω	-	1.5A to 6A
BLT5BPT_LN1*	p88	2020 (5050)	68Ω	-	11A
BLA2AAG (4 circuits array)	p89	0804 (2010)	120Ω to 1000Ω	-	50mA to 100mA
BLA2ABB/BD (4 circuits array)	p90	0804 (2010)	10Ω to 1000Ω	-	50mA to 200mA
BLA31AG (4 circuits array)	p92	1206 (3216)	30Ω to 1000Ω	-	50mA to 200mA
BLA31BD (4 circuits array)	p93	1206 (3216)	120Ω to 1000Ω	-	50mA to 150mA
BLM03HB/HD/HG	p94	0201 (0603)	190Ω to 1800Ω	750Ω to 3000Ω	100mA to 200mA
BLM03EB*	p96	0201 (0603)	25Ω to 50Ω	105Ω to 255Ω	400mA to 600mA
BLM15HB/HD/HG	p97	0402 (1005)	120Ω to 1800Ω	500Ω to 2700Ω	200mA to 300mA
BLM15EG*	p99	0402 (1005)	120Ω to 220Ω	145Ω to 270Ω	700mA to 1.5A
BLM15EX*	p100	0402 (1005)	120Ω to 470Ω	170Ω to 630Ω	950mA to 1.8A
BLM15GA/GG	p102	0402 (1005)	75Ω to 470Ω	600Ω to 1200Ω	200mA to 300mA
BLM18HB/HD/HE*/HG/HK	p103	0603 (1608)	120Ω to 1500Ω	400Ω to 1700Ω	50mA to 800mA
BLM18EG*	p107	0603 (1608)	100Ω to 600Ω	140Ω to 700Ω	500mA to 2A
BLM18GG	p109	0603 (1608)	470Ω	1800Ω	200mA

* The derating of rated current is required for some items according to the operating temperature on each product page.

NFZ_S

Noise filter for audio lines

Part Number	Size Code in inches (mm)	Impedance				Rated Current
		at 1MHz	at 100MHz	at 900MHz	at 1.7GHz	
NFZ03SG	p126 0201 (0603)	-	-	330Ω to 1600Ω	400Ω to 1200Ω	180mA to 305mA
NFZ15SG	p127 0402 (1005)	-	-	100Ω to 4600Ω	160Ω to 1800Ω	270mA to 1.1A
NFZ18SM*	p129 0603 (1608)	-	120Ω to 700Ω	-	-	800mA to 1.25A
NFZ2MSM	p131 0806 (2016)	-	100Ω to 600Ω	-	-	2.5A to 4A
NFZ32SW	p132 1210 (3225)	3.2Ω to 6.8Ω	300Ω to 900Ω	-	-	2.05A to 2.55A

* The derating of rated current is required for some items according to the operating temperature on each product page.

NFZ_B

Noise filter for LED lighting equipment

Part Number	Size Code in inches (mm)	Impedance (at 1MHz)	Rated Current
NFZ2HBM	p133 1008 (2520)	1.5Ω to 60Ω	400mA to 1.2A
NFZ32BW*	p135 1210 (3225)	3.3Ω to 880Ω	200mA to 2.9A
NFZ5BBW*	p139 2020 (5050)	2.9Ω to 140Ω	1.05A to 4A

* The derating of rated current is required for some items according to the operating temperature on each product page.

BLF

Frequency specified noise filter

Part Number	Size Code in inches (mm)	Target Frequency	Rated Current
BLF02JD*	p142 01005 (0402)	700MHz	330mA to 380mA
BLF02RD*	p143 01005 (0402)	2.4GHz	200mA to 330mA
BLF03JD*	p144 0201 (0603)	700MHz	480mA

* The derating of rated current is required for some items according to the operating temperature on each product page.

BLE

Noise filter for power charger lines

Part Number	Size Code in inches (mm)	Impedance (at 100MHz)	Rated Current
BLE18PS*	p145 0603 (1608)	8.5Ω	8A
BLE32PN	p146 1210 (3225)	26Ω to 30Ω	10A

* The derating of rated current is required for some items according to the operating temperature on each product page.

LQW_CA

Inductor for audio line noise suppression

Part Number	Size Code in inches (mm)	Inductance	Rated Current
LQW04CA_00	p147 03019 (0805)	60nH to 510nH	200mA to 620mA
LQW15CA_00	p148 0402 (1005)	22nH to 2000nH	130mA to 1300mA
LQW18CA_00	p150 0603 (1608)	32nH to 580nH	450mA to 2200mA

NFE

Feed-Through Chip EMI Filters

Part Number		Size Code in inches (mm)	Capacitance	Rated Current
NFE31PT	p172	1206 (3216)	22pF to 2200pF	6A
NFE61PT	p173	2706 (6816)	33pF to 4700pF	2A

NFL/NFA/NFW

LC Combined Chip EMI Filters

Part Number		Size Code in inches (mm)	Nominal Cut-off Frequency	Rated Current
NFL18ST	p174	0603 (1608)	50MHz to 500MHz	75mA to 200mA
NFL18SP	p176	0603 (1608)	150MHz to 500MHz	100mA
NFL21SP	p177	0805 (2012)	10MHz to 500MHz	100mA to 300mA
NFA18SL (4 circuits array)	p178	0603 (1608)	50MHz to 480MHz	25mA to 100mA
NFA18SD (4 circuits array)	p181	0603 (1608)	180MHz to 200MHz	25mA
NFA21SL (4 circuits array)	p182	0805 (2012)	50MHz to 330MHz	20mA to 100mA
NFW31SP	p184	1206 (3216)	10MHz to 500MHz	200mA

DLM/DLP/DLW/NFP

Common Mode Choke Coil/Common Mode Noise Filter

Part Number	Size Code in inches (mm)	Common Mode Impedance (at 100MHz)	Rated Current
DLM0QS (Limited for differential signal interface line) <small>p202</small>	025020(0605)	12Ω to 90Ω	50mA to 150mA
DLM0NS (Limited for differential signal interface line) <small>p203</small>	03025(0806)	12Ω to 90Ω	100mA to 160mA
DLM11G <small>p205</small>	0504(1210)	600Ω	100mA
DLM11S <small>p206</small>	0504(1210)	45Ω to 90Ω	100mA
DLP0QS <small>p207</small>	025020(0605)	7Ω to 35Ω	100mA
DLP0NS <small>p208</small>	03025(0806)	7Ω to 120Ω	75mA to 110mA
DLP11R <small>p210</small>	0504(1210)	15Ω to 45Ω	100mA
DLP11S <small>p212</small>	0504(1210)	35Ω to 330Ω	80mA to 180mA
DLP11T <small>p214</small>	0504(1210)	80Ω	100mA
DLP31S <small>p215</small>	1206(3216)	120Ω to 550Ω	100mA
DLP1ND (2 circuits array) <small>p216</small>	05025(1506)	35Ω to 90Ω	60mA to 100mA
DLP2AD (2 circuits array) <small>p217</small>	0804(2010)	35Ω to 280Ω	80mA to 150mA
DLP31D (2 circuits array) <small>p219</small>	1206(3216)	90Ω to 440Ω	70mA to 160mA
DLW21H <small>p220</small>	0805(2012)	67Ω to 180Ω	200mA to 330mA
DLW21S <small>p222</small>	0805(2012)	67Ω to 920Ω	160mA to 400mA
DLW31S <small>p225</small>	1206(3216)	90Ω to 2200Ω	200mA to 370mA
NFP0Q <small>p226</small>	025020(0605)	90Ω	100mA
DLW44S* <small>p228</small>	1515(4040)	100Ω to 2400Ω	1.1A to 3.1A
DLW5AH_SQ2/DLW5BS_SQ2* <small>p229</small>	2014(5036)/2020(5050)	190Ω to 4000Ω	200mA to 5A
DLW5AT_SQ2* <small>p231</small>	2014(5036)	110Ω to 2700Ω	1A to 5A
DLW5AT_MQ2* <small>p233</small>	2014(5036)	50Ω to 1100Ω	2A to 6A
DLW5AT_TQ2* <small>p234</small>	2014(5036)	110Ω to 500Ω	2A to 5A
DLW5BS_TQ2* <small>p235</small>	2020(5050)	500Ω to 800Ω	1A to 2A
DLW5BT_SQ2* <small>p236</small>	2020(5050)	100Ω to 1400Ω	1.5A to 6A
DLW5BT_TQ2* <small>p237</small>	2020(5050)	100Ω to 1400Ω	2A to 6A

* The derating of rated current is required for some items according to the operating temperature on each product page.

PL□

Large Current Common Mode Choke Coil for Automotive Available

Part Number	Size Code in inches (mm)	Common Mode Impedance (at 10MHz)	Rated Current
PLT5BPH* <small>p238</small>	2020(5050)	100Ω to 500Ω	3.1A to 5.6A
PLT10HH* <small>p239</small>	(12.9×6.6)	45Ω to 1000Ω	6A to 18A

* The derating of rated current is required for some items according to the operating temperature on each product page.

BNX

Block Type EMIFIL®

	Part Number	Rated Voltage	Rated Current
SMD Type	BNX02 □* <small>p256</small>	6.3Vdc to 100Vdc	20A
Lead Type	BNX01 □* <small>p258</small>	25Vdc to 50Vdc	15A

* The derating of rated current is required for some items according to the operating temperature on each product page.

Chip Ferrite Bead BLM/BLA/BLT Series

Series Introduction	p16
Part Numbering	p18
Series Lineup	p19
Product Detail	p26
⚠Caution/Notice	p110
Soldering and Mounting	p111
Packaging	p115

Chip Ferrite Bead (BL□) Series Introduction

● Example of Chip Ferrite Bead BLM Series Structure

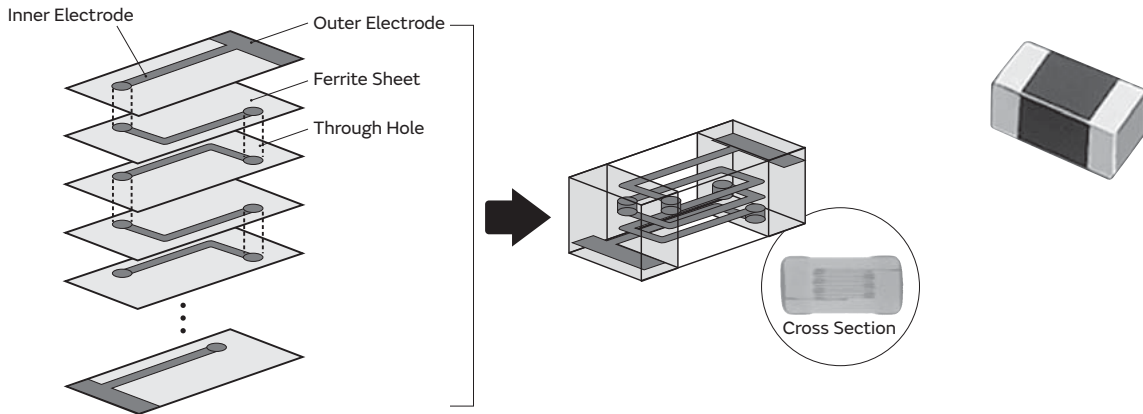

● Lineup Classification of Chip Ferrite Bead

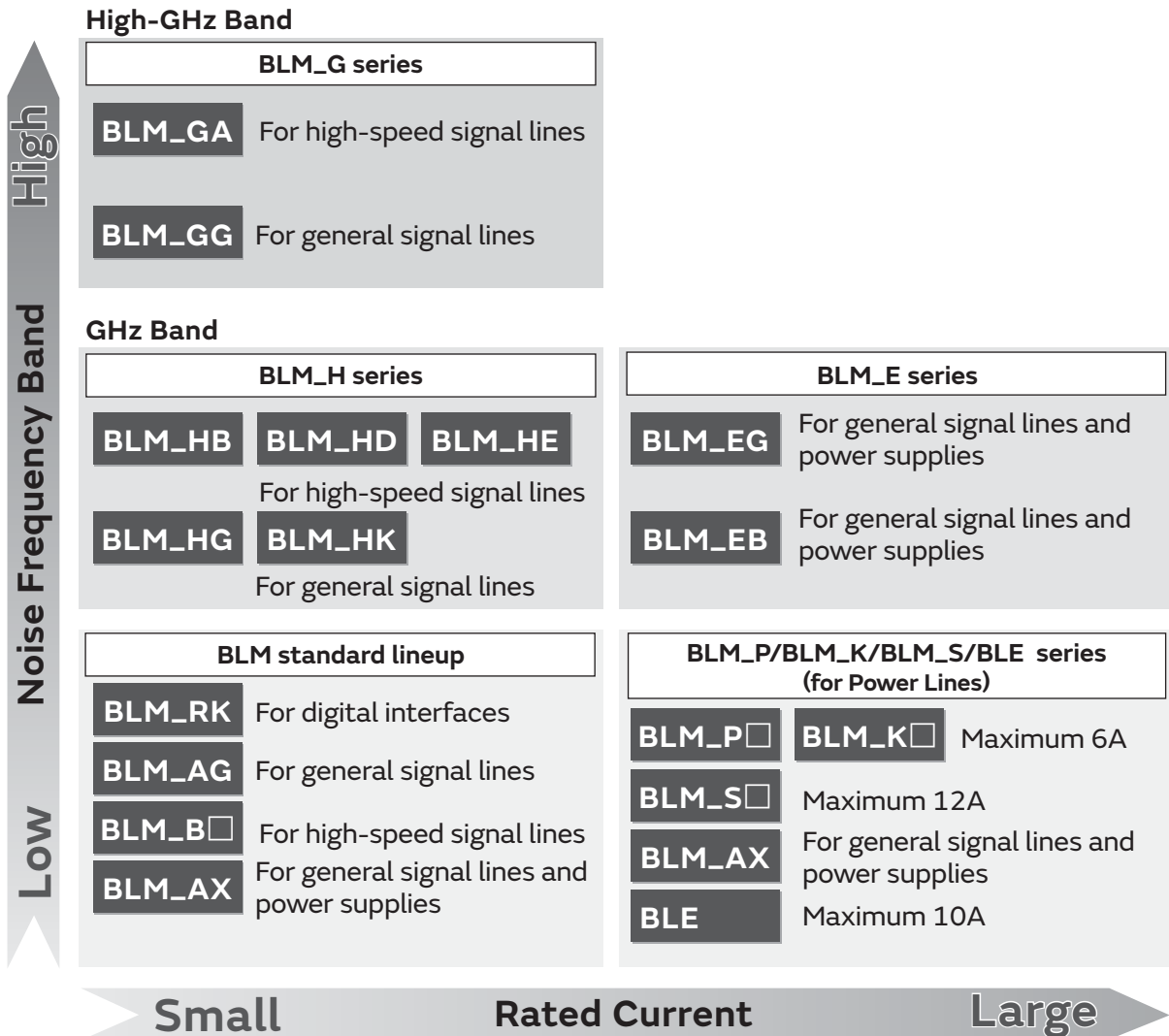

Chip Ferrite Bead (BL□) Series Introduction

●Difference between BLM A type and B type (HG type vs HD/HB/HE type)

A type: Impedance curve rises from low frequency range. Suppresses noise in a wide frequency range.
 B type: Impedance curve rises sharply. Less damage to signal waveforms.

Comparison of Impedance Curve

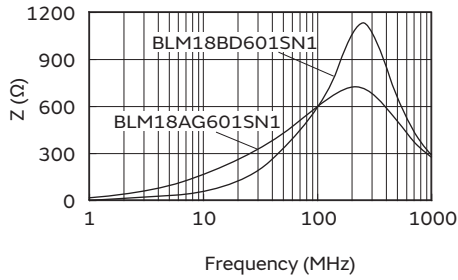

Comparison of Resistance Element

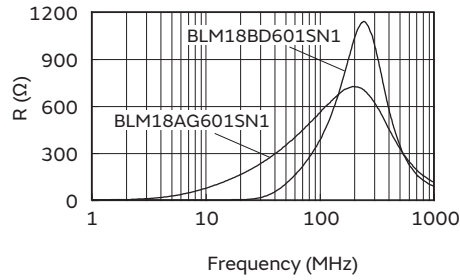

Comparison of Test Effect (25MHz)

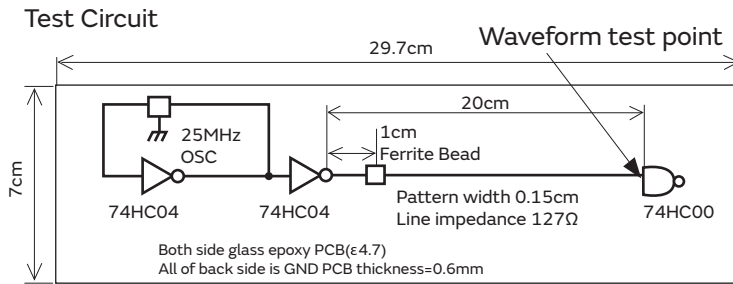

BLM_B Series has less damage to high-speed signal waveform.

Waveform

No filter

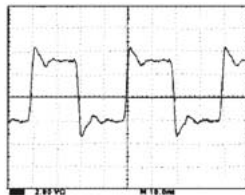

BLM18AG601SN1

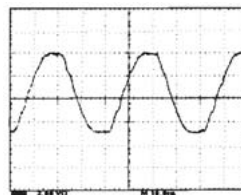

BLM18BD601SN1



Spectrum

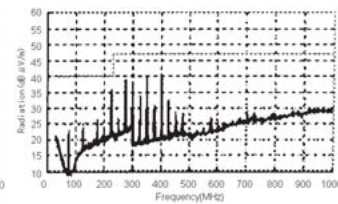
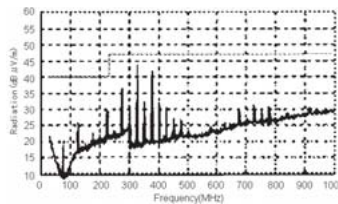
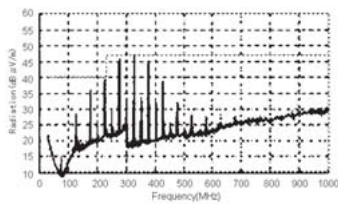

Spectrum has been reduced from low frequency range.

Noise frequency has been reduced without reducing signals of low frequency.

● Part Numbering

Chip Ferrite Bead

(Part Number)



① Product ID

Product ID	
BL	Chip Ferrite Beads

② Type

Code	Type
A	Array Type
M	Ferrite Bead Single Type
T	Assembly Type

④ Characteristics/Applications

Code *1	Characteristics/Applications
AG	For General Use
AX	
TG	
BA	For High-speed Signal Lines
BB	
BC	
BD	
BX	
KD	
KG	For Power Lines
KN	
KX	
PD	
PG	
PX	
PT	
SD	
SG	
SN	
SP	
RK	For Digital Interface
HG	For GHz Band General Use
EB	For GHz Band High-speed Signal Lines (Low Direct Current Type)
EG	For GHz Band General Use (Low DC Resistance Type)
EX	
HB	For GHz Band High-speed Signal Lines
HD	
HE	
HK	For GHz Band Digital Interface
GA	For High-GHz Band High-speed Signal Lines
GG	For High-GHz Band General Use

*1 Frequency characteristics vary with each code.

③ Dimensions (LxW)

Code	Dimensions (LxW)	Size Code (inch)
02	0.4x0.2mm	01005
03	0.6x0.3mm	0201
15	1.0x0.5mm	0402
18	1.6x0.8mm	0603
2A	2.0x1.0mm	0804
21	2.0x1.25mm	0805
31	3.2x1.6mm	1206
41	4.5x1.6mm	1806
5B	5.0x5.0mm	2020

⑤ Impedance

Expressed by three figures. The unit is in ohm (Ω) at 100MHz. The first and second figures are significant digits, and the third figure expresses the number of zeros that follow the two figures.

⑥ Electrode

Expressed by a letter.

Ex.)

Code	Electrode
S/F/T	Sn Plating
A	Au Plating
L	Lead-Free Solder Plating

⑦ Category

Code	Category
N	For General-Purpose

⑧ Number of Circuits

Code	Number of Circuits
1	1 Circuit
4	4 Circuits

⑨ Packaging

Code	Packaging
K	Embossed Taping (ϕ 330mm Reel)
L	Embossed Taping (ϕ 180mm Reel)
B	Bulk
J	Paper Taping (ϕ 330mm Reel)
D	Paper Taping (ϕ 180mm Reel)

Series Lineup

BLM/BLA/BLT

Chip Ferrite Bead

Type	Size Code in inches (mm)	Thickness (mm)	Part Number	Impedance		Rated Current	
				at 100MHz	at 1GHz		
For Power Lines	01005 (0402)	0.2	BLM02PX100SN1 ^{p26}	10Ω±5Ω	-	1.1A	
		0.2	BLM02PX220SN1 ^{p26}	22Ω±25%	-	750mA	
		0.2	BLM02PX330SN1 ^{p26}	33Ω±25%	-	550mA	
		0.2	BLM02PX600SN1 ^{p26}	60Ω±25%	-	500mA	
		0.3	BLM02KX100SN1 ^{p28}	10Ω±5Ω	-	1.5A	
		0.3	BLM02KX180SN1 ^{p28}	18Ω±25%	-	1.2A	
Universal Type [Power Lines/Signal Lines]		0.2	BLM02AX100SN1 ^{p29}	10Ω±5Ω	-	750mA	
		0.2	BLM02AX700SN1 ^{p29}	70Ω±25%	-	300mA	
		0.2	BLM02AX121SN1 ^{p29}	120Ω±25%	-	250mA	
For High-Speed Signal Lines		0.2	BLM02AX241SN1 ^{p29}	240Ω±25%	-	200mA	
		0.2	BLM02BB101SN1 ^{p31}	100Ω±25%	-	125mA	
		0.2	BLM02BC100SN1 ^{p31}	10Ω±5Ω	95Ω±50%	250mA	
		0.2	BLM02BC220SN1 ^{p31}	22Ω±25%	240Ω±40%	200mA	
		0.2	BLM02BX121SN1 ^{p32}	120Ω±25%	-	350mA	
		0.2	BLM02BX151SN1 ^{p32}	150Ω±25%	-	280mA	
For Power Lines		0.2	BLM02BX241SN1 ^{p32}	240Ω±25%	-	240mA	
		0201 (0603)	0.3	BLM03PG220SN1 ^{p33}	22Ω±25%	-	900mA
			0.3	BLM03PG330SN1 ^{p33}	33Ω±25%	-	750mA
	0.3		BLM03PX220SN1 ^{p34}	22Ω±25%	-	1.8A	
	0.3		BLM03PX330SN1 ^{p34}	33Ω±25%	-	1.5A	
	0.3		BLM03PX800SN1 ^{p34}	80Ω±25%	-	1A	
0.3	BLM03PX121SN1 ^{p34}		120Ω±25%	-	900mA		
For General Signal Lines	0.3	BLM03AG100SN1 ^{p36}	10Ω (Typ.)	-	500mA		
	0.3	BLM03AG700SN1 ^{p36}	70Ω (Typ.)	-	200mA		
	0.3	BLM03AG800SN1 ^{p36}	80Ω±25%	-	200mA		
	0.3	BLM03AG121SN1 ^{p36}	120Ω±25%	-	200mA		
	0.3	BLM03AG241SN1 ^{p36}	240Ω±25%	-	200mA		
	0.3	BLM03AG601SN1 ^{p36}	600Ω±25%	-	100mA		
Universal Type [Power Lines/Signal Lines]	0.3	BLM03AG102SN1 ^{p36}	1000Ω±25%	-	100mA		
	0.3	BLM03AX100SN1 ^{p38}	10Ω (Typ.)	-	1A		
	0.3	BLM03AX800SN1 ^{p38}	80Ω±25%	-	500mA		
	0.3	BLM03AX121SN1 ^{p38}	120Ω±25%	-	450mA		
	0.3	BLM03AX241SN1 ^{p38}	240Ω±25%	-	350mA		
	0.3	BLM03AX601SN1 ^{p38}	600Ω±25%	-	250mA		
For High-Speed Signal Lines (Sharp Impedance Curve)	0.3	BLM03AX102SN1 ^{p38}	1000Ω±25%	-	200mA		
	0.3	BLM03BB100SN1 ^{p39}	10Ω±25%	-	300mA		
	0.3	BLM03BB220SN1 ^{p39}	22Ω±25%	-	200mA		
	0.3	BLM03BB470SN1 ^{p39}	47Ω±25%	-	200mA		
	0.3	BLM03BB750SN1 ^{p39}	75Ω±25%	-	200mA		
	0.3	BLM03BB121SN1 ^{p39}	120Ω±25%	-	100mA		
	0.3	BLM03BC330SN1 ^{p39}	33Ω±25%	-	150mA		
	0.3	BLM03BC560SN1 ^{p39}	56Ω±25%	-	100mA		
	0.3	BLM03BC800SN1 ^{p39}	80Ω±25%	-	100mA		
	0.3	BLM03BD750SN1 ^{p39}	75Ω±25%	-	300mA		
	0.3	BLM03BD121SN1 ^{p39}	120Ω±25%	-	250mA		
	0.3	BLM03BD241SN1 ^{p39}	240Ω±25%	-	200mA		
	0.3	BLM03BD471SN1 ^{p39}	470Ω±25%	-	215mA		
	0.3	BLM03BD601SN1 ^{p39}	600Ω±25%	-	200mA		
	0.3	BLM03BX102SN1 ^{p41}	1000Ω±25%	-	170mA		
0.3	BLM03BX182SN1 ^{p41}	1800Ω±25%	-	140mA			

Continued on the following page. ↗

Chip Ferrite Bead

Application Specified Noise Filter

Chip EMIFIL®

Common Mode Choke Coil
 Common Mode Noise Filter

Block Type EMIFIL®

EMC Absorber

Chip Ferrite Bead

Application Specified Noise Filter

Chip EMIFIL®

Common Mode Choke Coil
 Common Mode Noise Filter

Block Type EMIFIL®

EMC Absorber

Type	Size Code in inches (mm)	Thickness (mm)	Part Number	Impedance		Rated Current
				at 100MHz	at 1GHz	
For Power Lines	0402 (1005)	0.5	BLM15PD300SN1 ^{p42}	30Ω±25%	-	2.2A
		0.5	BLM15PD600SN1 ^{p42}	60Ω±25%	-	1.7A
		0.5	BLM15PD800SN1 ^{p42}	80Ω±25%	-	1.5A
		0.5	BLM15PD121SN1 ^{p42}	120Ω±25%	-	1.3A
		0.5	BLM15PG100SN1 ^{p42}	10Ω (Typ.)	-	1A
		0.5	BLM15PX330SN1 ^{p44}	33Ω±25%	-	3A
		0.5	BLM15PX600SN1 ^{p44}	60Ω±25%	-	2.5A
		0.5	BLM15PX800SN1 ^{p44}	80Ω±25%	-	2.3A
		0.5	BLM15PX121SN1 ^{p44}	120Ω±25%	-	2A
		0.5	BLM15PX181SN1 ^{p44}	180Ω±25%	-	1.5A
		0.5	BLM15PX221SN1 ^{p44}	220Ω±25%	-	1.4A
		0.5	BLM15PX331SN1 ^{p44}	330Ω±25%	-	1.2A
		0.5	BLM15PX471SN1 ^{p44}	470Ω±25%	-	1A
		0.5	BLM15PX601SN1 ^{p44}	600Ω±25%	-	900mA
		For General Signal Lines	0402 (1005)	0.5	BLM15KD200SN1 ^{p46}	20Ω±25%
0.5	BLM15KD300SN1 ^{p46}			30Ω±25%	-	3.1A
0.5	BLM15KD121SN1 ^{p46}			120Ω±25%	-	1.5A
0.5	BLM15AG100SN1 ^{p47}			10Ω (Typ.)	-	1A
0.5	BLM15AG700SN1 ^{p47}			70Ω (Typ.)	-	600mA
0.5	BLM15AG121SN1 ^{p47}			120Ω±25%	-	550mA
Universal Type [Power Lines/Signal Lines]	0402 (1005)	0.5	BLM15AG221SN1 ^{p47}	220Ω±25%	-	450mA
		0.5	BLM15AG601SN1 ^{p47}	600Ω±25%	-	300mA
		0.5	BLM15AG102SN1 ^{p47}	1000Ω±25%	-	300mA
		0.5	BLM15AX100SN1 ^{p48}	10Ω±5Ω	-	1.74A
		0.5	BLM15AX300SN1 ^{p48}	30Ω±25%	-	1.1A
		0.5	BLM15AX700SN1 ^{p48}	70Ω±25%	-	780mA
		0.5	BLM15AX121SN1 ^{p48}	120Ω±25%	-	700mA
		0.5	BLM15AX221SN1 ^{p48}	220Ω±25%	-	600mA
For High-Speed Signal Lines (Sharp Impedance Curve)	0402 (1005)	0.5	BLM15AX601SN1 ^{p48}	600Ω±25%	-	500mA
		0.5	BLM15AX102SN1 ^{p48}	1000Ω±25%	-	350mA
		0.5	BLM15BA050SN1 ^{p50}	5Ω±25%	-	300mA
		0.5	BLM15BA100SN1 ^{p50}	10Ω±25%	-	300mA
		0.5	BLM15BA220SN1 ^{p50}	22Ω±25%	-	300mA
		0.5	BLM15BA330SN1 ^{p50}	33Ω±25%	-	300mA
		0.5	BLM15BA470SN1 ^{p50}	47Ω±25%	-	200mA
		0.5	BLM15BA750SN1 ^{p50}	75Ω±25%	-	200mA
		0.5	BLM15BB050SN1 ^{p50}	5Ω±25%	-	500mA
		0.5	BLM15BB100SN1 ^{p50}	10Ω±25%	-	300mA
		0.5	BLM15BB220SN1 ^{p50}	22Ω±25%	-	300mA
		0.5	BLM15BB470SN1 ^{p50}	47Ω±25%	-	300mA
		0.5	BLM15BB750SN1 ^{p50}	75Ω±25%	-	300mA
		0.5	BLM15BB121SN1 ^{p50}	120Ω±25%	-	300mA
		0.5	BLM15BB221SN1 ^{p50}	220Ω±25%	-	200mA
		0.5	BLM15BC121SN1 ^{p50}	120Ω±25%	-	350mA
		0.5	BLM15BC241SN1 ^{p50}	240Ω±25%	-	250mA
		0.5	BLM15BD750SN1 ^{p50}	75Ω±25%	-	300mA
		0.5	BLM15BD121SN1 ^{p50}	120Ω±25%	-	300mA
		0.5	BLM15BD221SN1 ^{p50}	220Ω±25%	-	300mA
0.5	BLM15BD471SN1 ^{p50}	470Ω±25%	-	200mA		
0.5	BLM15BD601SN1 ^{p50}	600Ω±25%	-	200mA		
0.5	BLM15BD102SN1 ^{p50}	1000Ω±25%	-	200mA		

Continued on the following page. ↗

Type	Size Code in inches (mm)	Thickness (mm)	Part Number	Impedance		Rated Current
				at 100MHz	at 1GHz	
For High-Speed Signal Lines (Sharp Impedance Curve)	0402 (1005)	0.5	BLM15BD152SN1 ^{p50}	1500Ω±25%	-	190mA
		0.5	BLM15BD182SN1 ^{p50}	1800Ω±25%	-	100mA
		0.5	BLM15BX750SN1 ^{p53}	75Ω±25%	-	600mA
		0.5	BLM15BX121SN1 ^{p53}	120Ω±25%	-	600mA
		0.5	BLM15BX221SN1 ^{p53}	220Ω±25%	-	450mA
		0.5	BLM15BX471SN1 ^{p53}	470Ω±25%	-	350mA
		0.5	BLM15BX601SN1 ^{p53}	600Ω±25%	-	350mA
		0.5	BLM15BX102SN1 ^{p53}	1000Ω±25%	-	300mA
For Power Lines Standard Type	0603 (1608)	0.8	BLM18PG300SN1 ^{p55}	30Ω (Typ.)	-	1A
		0.8	BLM18PG330SN1 ^{p55}	33Ω±25%	-	3A
		0.8	BLM18PG600SN1 ^{p55}	60Ω (Typ.)	-	1A
		0.8	BLM18PG121SN1 ^{p55}	120Ω±25%	-	2A
		0.8	BLM18PG181SN1 ^{p55}	180Ω±25%	-	1.5A
		0.8	BLM18PG221SN1 ^{p55}	220Ω±25%	-	1.4A
		0.8	BLM18PG331SN1 ^{p55}	330Ω±25%	-	1.2A
		0.8	BLM18PG471SN1 ^{p55}	470Ω±25%	-	1A
For Power Lines Low DC Resistance Type	0603 (1608)	0.8	BLM18KG221SN1 ^{p57}	220Ω±25%	-	2.2A
		0.8	BLM18KG331SN1 ^{p57}	330Ω±25%	-	1.7A
		0.8	BLM18KG471SN1 ^{p57}	470Ω±25%	-	1.5A
		0.8	BLM18KG601SN1 ^{p57}	600Ω±25%	-	1.3A
		0.8	BLM18KG102SN1 ^{p57}	1000Ω±25%	-	1A
		0.6	BLM18KG260TN1 ^{p57}	26Ω±25%	-	6A
		0.6	BLM18KG300TN1 ^{p57}	30Ω±25%	-	5A
		0.6	BLM18KG700TN1 ^{p57}	70Ω±25%	-	3.5A
		0.6	BLM18KG101TN1 ^{p57}	100Ω±25%	-	3A
		0.6	BLM18KG121TN1 ^{p57}	120Ω±25%	-	3A
		0.8	BLM18SD220SN1 ^{p59}	22Ω±25%	-	6A
		0.8	BLM18SG330SN1 ^{p59}	33Ω±25%	-	6A
		0.5	BLM18SG260TN1 ^{p59}	26Ω±25%	-	6A
		0.5	BLM18SG700TN1 ^{p59}	70Ω±25%	-	4A
For General Signal Lines	0603 (1608)	0.5	BLM18SG121TN1 ^{p59}	120Ω±25%	-	3A
		0.5	BLM18SG221TN1 ^{p60}	220Ω±25%	-	2.5A
		0.5	BLM18SG331TN1 ^{p60}	330Ω±25%	-	1.5A
		0.6	BLM18SN220TN1 ^{p60}	22Ω±7Ω	-	8A
		0.8	BLM18AG121SN1 ^{p62}	120Ω±25%	-	800mA
		0.8	BLM18AG151SN1 ^{p62}	150Ω±25%	-	700mA
		0.8	BLM18AG221SN1 ^{p62}	220Ω±25%	-	700mA
		0.8	BLM18AG331SN1 ^{p62}	330Ω±25%	-	600mA
		0.8	BLM18AG471SN1 ^{p62}	470Ω±25%	-	550mA
		0.8	BLM18AG601SN1 ^{p62}	600Ω±25%	-	500mA
For High-Speed Signal Lines (Sharp Impedance Curve)	0603 (1608)	0.8	BLM18AG102SN1 ^{p62}	1000Ω±25%	-	450mA
		0.6	BLM18TG121TN1 ^{p64}	120Ω±25%	-	200mA
		0.6	BLM18TG221TN1 ^{p64}	220Ω±25%	-	200mA
		0.6	BLM18TG601TN1 ^{p64}	600Ω±25%	-	200mA
		0.6	BLM18TG102TN1 ^{p64}	1000Ω±25%	-	100mA
		0.8	BLM18BA050SN1 ^{p65}	5Ω±25%	-	500mA
For High-Speed Signal Lines (Sharp Impedance Curve)	0603 (1608)	0.8	BLM18BA100SN1 ^{p65}	10Ω±25%	-	500mA
		0.8	BLM18BA220SN1 ^{p65}	22Ω±25%	-	500mA
		0.8	BLM18BA470SN1 ^{p65}	47Ω±25%	-	300mA
		0.8	BLM18BA750SN1 ^{p65}	75Ω±25%	-	300mA

Continued on the following page. ↗

Chip Ferrite Bead

Application Specified Noise Filter

Chip EMIFIL®

Common Mode Choke Coil
 Common Mode Noise Filter

Block Type EMIFIL®

EMC Absorber

Type	Size Code in inches (mm)	Thickness (mm)	Part Number	Impedance		Rated Current		
				at 100MHz	at 1GHz			
For High-Speed Signal Lines (Sharp Impedance Curve)	0603 (1608)	0.8	BLM18BA121SN1 ^{p65}	120Ω±25%	-	200mA		
		0.8	BLM18BB050SN1 ^{p65}	5Ω±25%	-	800mA		
		0.8	BLM18BB100SN1 ^{p65}	10Ω±25%	-	700mA		
		0.8	BLM18BB220SN1 ^{p65}	22Ω±25%	-	700mA		
		0.8	BLM18BB470SN1 ^{p65}	47Ω±25%	-	600mA		
		0.8	BLM18BB600SN1 ^{p65}	60Ω±25%	-	600mA		
		0.8	BLM18BB750SN1 ^{p65}	75Ω±25%	-	600mA		
		0.8	BLM18BB121SN1 ^{p65}	120Ω±25%	-	550mA		
		0.8	BLM18BB141SN1 ^{p65}	140Ω±25%	-	500mA		
		0.8	BLM18BB151SN1 ^{p65}	150Ω±25%	-	450mA		
		0.8	BLM18BB221SN1 ^{p65}	220Ω±25%	-	450mA		
		0.8	BLM18BB331SN1 ^{p65}	330Ω±25%	-	400mA		
		0.8	BLM18BB471SN1 ^{p65}	470Ω±25%	-	300mA		
		0.8	BLM18BD470SN1 ^{p65}	47Ω±25%	-	500mA		
		0.8	BLM18BD121SN1 ^{p65}	120Ω±25%	-	300mA		
		0.8	BLM18BD151SN1 ^{p65}	150Ω±25%	-	300mA		
		0.8	BLM18BD221SN1 ^{p65}	220Ω±25%	-	250mA		
		0.8	BLM18BD331SN1 ^{p65}	330Ω±25%	-	250mA		
		0.8	BLM18BD421SN1 ^{p65}	420Ω±25%	-	250mA		
		0.8	BLM18BD471SN1 ^{p65}	470Ω±25%	-	250mA		
		0.8	BLM18BD601SN1 ^{p65}	600Ω±25%	-	200mA		
		For Digital Interface Lines	0603 (1608)	0.8	BLM18BD102SN1 ^{p65}	1000Ω±25%	-	200mA
				0.8	BLM18BD152SN1 ^{p65}	1500Ω±25%	-	150mA
0.8	BLM18BD182SN1 ^{p65}			1800Ω±25%	-	150mA		
0.8	BLM18BD222SN1 ^{p65}			2200Ω±25%	-	150mA		
0.8	BLM18BD252SN1 ^{p65}			2500Ω±25%	-	150mA		
For Power Lines	0805 (2012)	0.85	BLM18RK121SN1 ^{p69}	120Ω±25%	-	200mA		
		0.85	BLM18RK221SN1 ^{p69}	220Ω±25%	-	200mA		
		0.85	BLM18RK471SN1 ^{p69}	470Ω±25%	-	200mA		
		0.85	BLM18RK601SN1 ^{p69}	600Ω±25%	-	200mA		
		0.85	BLM18RK102SN1 ^{p69}	1000Ω±25%	-	200mA		
For General Signal Lines	0805 (2012)	0.85	BLM21PG220SN1 ^{p71}	22Ω±25%	-	6A		
		0.85	BLM21PG300SN1 ^{p71}	30Ω (Typ.)	-	4A		
		0.85	BLM21PG600SN1 ^{p71}	60Ω±25%	-	3.5A		
		0.85	BLM21PG121SN1 ^{p71}	120Ω±25%	-	3A		
		0.85	BLM21PG221SN1 ^{p71}	220Ω±25%	-	2A		
		0.85	BLM21PG331SN1 ^{p71}	330Ω±25%	-	1.5A		
		0.85	BLM21SN300SN1 ^{p73}	30Ω±10Ω	-	8.5A		
		0.85	BLM21SP700SN1 ^{p73}	70Ω±25%	-	6A		
		0.85	BLM21SP111SN1 ^{p73}	110Ω±25%	-	5A		
		0.85	BLM21SP181SN1 ^{p73}	180Ω±25%	-	4A		
		0.85	BLM21SP331SN1 ^{p73}	330Ω±25%	-	2.8A		
		0.85	BLM21SP471SN1 ^{p73}	470Ω±25%	-	2.5A		
		0.85	BLM21SP601SN1 ^{p73}	600Ω±25%	-	2.3A		
		0.85	BLM21SP102SN1 ^{p73}	1000Ω±25%	-	1.6A		
		For General Signal Lines	0805 (2012)	0.85	BLM21AG121SN1 ^{p75}	120Ω±25%	-	1A
0.85	BLM21AG151SN1 ^{p75}			150Ω±25%	-	1A		
0.85	BLM21AG221SN1 ^{p75}			220Ω±25%	-	900mA		
0.85	BLM21AG331SN1 ^{p75}			330Ω±25%	-	800mA		
0.85	BLM21AG471SN1 ^{p75}			470Ω±25%	-	700mA		
0.85	BLM21AG601SN1 ^{p75}	600Ω±25%	-	700mA				

Continued on the following page. ↗

Type	Size Code in inches (mm)	Thickness (mm)	Part Number	Impedance		Rated Current		
				at 100MHz	at 1GHz			
For General Signal Lines		0.85	BLM21AG102SN1 ^{p75}	1000Ω±25%	-	600mA		
		0.85	BLM21BB050SN1 ^{p77}	5Ω±25%	-	1A		
For High-Speed Signal Lines (Sharp Impedance Curve)	0805 (2012)	0.85	BLM21BB600SN1 ^{p77}	60Ω±25%	-	800mA		
		0.85	BLM21BB750SN1 ^{p77}	75Ω±25%	-	700mA		
		0.85	BLM21BB121SN1 ^{p77}	120Ω±25%	-	600mA		
		0.85	BLM21BB151SN1 ^{p77}	150Ω±25%	-	600mA		
		0.85	BLM21BB201SN1 ^{p77}	200Ω±25%	-	500mA		
		0.85	BLM21BB221SN1 ^{p77}	220Ω±25%	-	500mA		
		0.85	BLM21BB331SN1 ^{p77}	330Ω±25%	-	400mA		
		0.85	BLM21BB471SN1 ^{p77}	470Ω±25%	-	400mA		
		0.85	BLM21BD121SN1 ^{p77}	120Ω±25%	-	350mA		
		0.85	BLM21BD151SN1 ^{p77}	150Ω±25%	-	350mA		
		0.85	BLM21BD221SN1 ^{p77}	220Ω±25%	-	350mA		
		0.85	BLM21BD331SN1 ^{p77}	330Ω±25%	-	300mA		
		0.85	BLM21BD421SN1 ^{p77}	420Ω±25%	-	300mA		
		0.85	BLM21BD471SN1 ^{p77}	470Ω±25%	-	300mA		
		0.85	BLM21BD601SN1 ^{p77}	600Ω±25%	-	300mA		
		0.85	BLM21BD751SN1 ^{p77}	750Ω±25%	-	250mA		
		0.85	BLM21BD102SN1 ^{p77}	1000Ω±25%	-	250mA		
		0.85	BLM21BD152SN1 ^{p77}	1500Ω±25%	-	250mA		
		0.85	BLM21BD182SN1 ^{p77}	1800Ω±25%	-	250mA		
		For Digital Interface Lines		1.25	BLM21BD222SN1 ^{p77}	2250Ω (Typ.)	-	250mA
1.25	BLM21BD272SN1 ^{p77}			2700Ω±25%	-	200mA		
0.85	BLM21BD222TN1 ^{p77}			2200Ω±25%	-	200mA		
0.85	BLM21RK121SN1 ^{p80}			120Ω±25%	-	200mA		
0.85	BLM21RK221SN1 ^{p80}			220Ω±25%	-	200mA		
0.85	BLM21RK471SN1 ^{p80}			470Ω±25%	-	200mA		
0.85	BLM21RK601SN1 ^{p80}			600Ω±25%	-	200mA		
0.85	BLM21RK102SN1 ^{p80}			1000Ω±25%	-	200mA		
For Power Lines	1206 (3216)			1.6	BLM31KN121SN1 ^{p81}	120Ω±25%	-	6A
				1.6	BLM31KN271SN1 ^{p81}	270Ω±25%	-	4.5A
		1.6	BLM31KN471SN1 ^{p81}	470Ω±25%	-	4A		
		1.6	BLM31KN601SN1 ^{p81}	600Ω±25%	-	2.9A		
		1.6	BLM31KN801SN1 ^{p81}	800Ω±25%	-	2.5A		
		1.6	BLM31KN102SN1 ^{p81}	1000Ω±25%	-	2A		
		1.1	BLM31PG330SN1 ^{p83}	33Ω±25%	-	6A		
		1.1	BLM31PG500SN1 ^{p83}	50Ω (Typ.)	-	3.5A		
		1.1	BLM31PG121SN1 ^{p83}	120Ω±25%	-	3.5A		
		1.1	BLM31PG391SN1 ^{p83}	390Ω±25%	-	2A		
	1.1	BLM31PG601SN1 ^{p83}	600Ω±25%	-	1.5A			
	1.1	BLM31SN500SN1 ^{p85}	50Ω±12.5Ω	-	12A			
	1806 (4516)	1.6	BLM41PG600SN1 ^{p86}	60Ω (Typ.)	-	6A		
		1.6	BLM41PG750SN1 ^{p86}	75Ω (Typ.)	-	3.5A		
		1.6	BLM41PG181SN1 ^{p86}	180Ω±25%	-	3.5A		
1.6		BLM41PG471SN1 ^{p86}	470Ω±25%	-	2A			
1.6		BLM41PG102SN1 ^{p86}	1000Ω±25%	-	1.5A			
For Power Lines	2020 (5050)	5.0	BLT5BPT680LN1 ^{p88}	68Ω (Typ.)	-	11A		
For General Signal Lines	0804 (2010)	0.5	BLA2AAG121SN4 ^{p89}	120Ω±25%	-	100mA		
		0.5	BLA2AAG221SN4 ^{p89}	220Ω±25%	-	50mA		
		0.5	BLA2AAG601SN4 ^{p89}	600Ω±25%	-	50mA		
		0.5	BLA2AAG102SN4 ^{p89}	1000Ω±25%	-	50mA		

Continued on the following page. ↗

Chip Ferrite Bead

Application Specified Noise Filter

Chip EMIFIL®

Common Mode Choke Coil
 Common Mode Noise Filter

Block Type EMIFIL®

EMC Absorber

Type	Size Code in inches (mm)	Thickness (mm)	Part Number	Impedance		Rated Current	
				at 100MHz	at 1GHz		
For High-Speed Signal Lines	0804 (2010)	0.5	BLA2ABB100SN4 ^{p90}	10Ω±25%	-	200mA	
		0.5	BLA2ABB220SN4 ^{p90}	22Ω±25%	-	200mA	
		0.5	BLA2ABB470SN4 ^{p90}	47Ω±25%	-	200mA	
		0.5	BLA2ABB121SN4 ^{p90}	120Ω±25%	-	50mA	
		0.5	BLA2ABB221SN4 ^{p90}	220Ω±25%	-	50mA	
		0.5	BLA2ABD750SN4 ^{p90}	75Ω±25%	-	200mA	
		0.5	BLA2ABD121SN4 ^{p90}	120Ω±25%	-	200mA	
		0.5	BLA2ABD221SN4 ^{p90}	220Ω±25%	-	100mA	
		0.5	BLA2ABD471SN4 ^{p90}	470Ω±25%	-	100mA	
		0.5	BLA2ABD601SN4 ^{p90}	600Ω±25%	-	100mA	
For General Signal Lines	1206 (3216)	0.8	BLA31AG300SN4 ^{p92}	30Ω±25%	-	200mA	
		0.8	BLA31AG600SN4 ^{p92}	60Ω±25%	-	200mA	
		0.8	BLA31AG121SN4 ^{p92}	120Ω±25%	-	150mA	
		0.8	BLA31AG221SN4 ^{p92}	220Ω±25%	-	150mA	
		0.8	BLA31AG601SN4 ^{p92}	600Ω±25%	-	100mA	
		0.8	BLA31AG102SN4 ^{p92}	1000Ω±25%	-	50mA	
For High-Speed Signal Lines		0.8	BLA31BD121SN4 ^{p93}	120Ω±25%	-	150mA	
		0.8	BLA31BD221SN4 ^{p93}	220Ω±25%	-	150mA	
		0.8	BLA31BD471SN4 ^{p93}	470Ω±25%	-	100mA	
		0.8	BLA31BD601SN4 ^{p93}	600Ω±25%	-	100mA	
		0.8	BLA31BD102SN4 ^{p93}	1000Ω±25%	-	50mA	
For GHz	For High-Speed Signal Lines	0201 (0603)	0.3	BLM03HB191SN1 ^{p94}	190Ω±25%	1150Ω±40%	150mA
			0.3	BLM03HB401SN1 ^{p94}	400Ω±25%	1850Ω±40%	125mA
			0.3	BLM03HD102FN1 ^{p94}	1000Ω±25%	2300Ω±40%	135mA
			0.3	BLM03HD152FN1 ^{p94}	1500Ω±25%	2700Ω±40%	120mA
			0.3	BLM03HD182FN1 ^{p94}	1800Ω±25%	3000Ω±40%	100mA
			0.3	BLM03HD331SN1 ^{p94}	330Ω±25%	750Ω±40%	200mA
			0.3	BLM03HD471SN1 ^{p94}	470Ω±25%	1000Ω±40%	175mA
			0.3	BLM03HD601SN1 ^{p94}	600Ω±25%	1500Ω±40%	150mA
			0.3	BLM03HD102SN1 ^{p94}	1000Ω±25%	2300Ω±40%	120mA
			0.3	BLM03HG601SN1 ^{p94}	600Ω±25%	1000Ω±40%	150mA
	For General Signal Lines		0.3	BLM03HG102SN1 ^{p94}	1000Ω±25%	1800Ω±40%	125mA
			0.3	BLM03HG122SN1 ^{p94}	1200Ω±25%	2000Ω±40%	100mA
	Universal Type [Power Lines/Signal Lines]		0.3	BLM03EB250SN1 ^{p96}	25Ω±25%	105Ω±40%	600mA
			0.3	BLM03EB500SN1 ^{p96}	50Ω±25%	255Ω±40%	400mA
	For High-Speed Signal Lines (Sharp Impedance Curve)		0.5	BLM15HB121SN1 ^{p97}	120Ω±25%	500Ω±40%	300mA
			0.5	BLM15HB221SN1 ^{p97}	220Ω±25%	900Ω±40%	250mA
			0.5	BLM15HD601SN1 ^{p97}	600Ω±25%	1400Ω±40%	300mA
			0.5	BLM15HD102SN1 ^{p97}	1000Ω±25%	2000Ω±40%	250mA
			0.5	BLM15HD182SN1 ^{p97}	1800Ω±25%	2700Ω±40%	200mA
	For General Signal Lines		0.5	BLM15HG601SN1 ^{p97}	600Ω±25%	1000Ω±40%	300mA
0.5			BLM15HG102SN1 ^{p97}	1000Ω±25%	1400Ω±40%	250mA	
Universal Type [Power Lines/Signal Lines]	0402 (1005)	0.5	BLM15EG121SN1 ^{p99}	120Ω±25%	145Ω (Typ.)	1.5A	
		0.5	BLM15EG221SN1 ^{p99}	220Ω±25%	270Ω (Typ.)	700mA	
		0.5	BLM15EX121SN1 ^{p100}	120Ω±25%	170Ω±40%	1.8A	
		0.5	BLM15EX221SN1 ^{p100}	220Ω±25%	300Ω±40%	1.3A	
		0.5	BLM15EX331SN1 ^{p100}	330Ω±25%	450Ω±40%	1.1A	
		0.5	BLM15EX471SN1 ^{p100}	470Ω±25%	630Ω±40%	950mA	
		0.5	BLM15GA750SN1 ^{p102}	75Ω±25%	1000Ω±40%	200mA	
		0.5	BLM15GG221SN1 ^{p102}	220Ω±25%	600Ω±40%	300mA	
For High-GHz Band Noise For High-Speed Signal Lines							
For High-GHz Band Noise For General Signal Lines							

Continued on the following page. ↗

Type	Size Code in inches (mm)	Thickness (mm)	Part Number	Impedance		Rated Current	
				at 100MHz	at 1GHz		
For GHz	For High-GHz Band Noise For General Signal Lines	0402 (1005)	0.5	BLM15GG471SN1 p102	470Ω±25%	1200Ω±40%	200mA
	For High-Speed Signal Lines (Sharp Impedance Curve)	0603 (1608)	0.8	BLM18HB121SN1 p103	120Ω±25%	500Ω±40%	200mA
			0.8	BLM18HB221SN1 p103	220Ω±25%	1100Ω±40%	100mA
			0.8	BLM18HB331SN1 p103	330Ω±25%	1600Ω±40%	50mA
			0.8	BLM18HD471SN1 p103	470Ω±25%	1000Ω (Typ.)	100mA
			0.8	BLM18HD601SN1 p103	600Ω±25%	1200Ω (Typ.)	100mA
			0.8	BLM18HD102SN1 p103	1000Ω±25%	1700Ω (Typ.)	50mA
			0.8	BLM18HE601SN1 p103	600Ω±25%	600Ω (Typ.)	800mA
			0.8	BLM18HE102SN1 p103	1000Ω±25%	1000Ω (Typ.)	600mA
			0.8	BLM18HE152SN1 p103	1500Ω±25%	1500Ω (Typ.)	500mA
			For General Signal Lines	0603 (1608)	0.8	BLM18HG471SN1 p103	470Ω±25%
	0.8	BLM18HG601SN1 p103			600Ω±25%	700Ω (Typ.)	200mA
	0.8	BLM18HG102SN1 p103			1000Ω±25%	1000Ω (Typ.)	100mA
	For Digital Interface Lines	0603 (1608)	0.8	BLM18HK331SN1 p103	330Ω±25%	400Ω±40%	200mA
			0.8	BLM18HK471SN1 p103	470Ω±25%	600Ω±40%	200mA
			0.8	BLM18HK601SN1 p103	600Ω±25%	700Ω±40%	100mA
			0.8	BLM18HK102SN1 p103	1000Ω±25%	1200Ω±40%	50mA
	Universal Type [Power Lines/Signal Lines]	0603 (1608)	0.8	BLM18EG121SN1 p107	120Ω±25%	145Ω (Typ.)	2A
			0.8	BLM18EG221SN1 p107	220Ω±25%	260Ω (Typ.)	2A
			0.8	BLM18EG471SN1 p107	470Ω±25%	550Ω (Typ.)	500mA
			0.8	BLM18EG601SN1 p107	600Ω±25%	700Ω (Typ.)	500mA
			0.5	BLM18EG101TN1 p107	100Ω±25%	140Ω (Typ.)	2A
			0.5	BLM18EG221TN1 p107	220Ω±25%	300Ω (Typ.)	1A
			0.5	BLM18EG331TN1 p107	330Ω±25%	450Ω (Typ.)	500mA
			0.5	BLM18EG391TN1 p107	390Ω±25%	520Ω (Typ.)	500mA
	For High-GHz Band Noise	0603 (1608)	0.8	BLM18GG471SN1 p109	470Ω±25%	1800Ω±30%	200mA

Chip Ferrite Bead

Application Specified Noise Filter

Chip EMIFIL®

Common Mode Choke Coil
 · Common Mode Noise Filter

Block Type EMIFIL®

EMC Absorber

Chip ferrite bead

BLM02PX Series 01005/0402(inch/mm)

Appearance/Dimensions

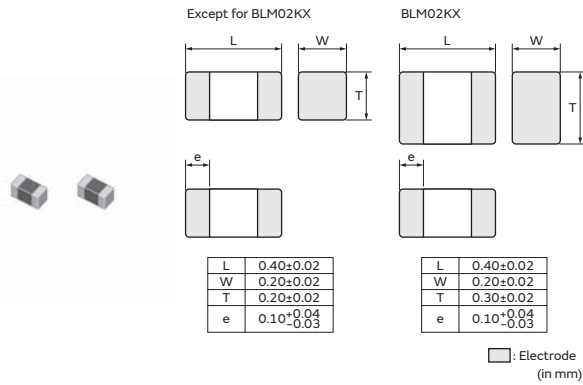

Packaging

Code	Packaging	Minimum Quantity
D	ø180mm Paper Tape	20000
B	Bulk(Bag)	1000

Equivalent Circuit



(Resistance element becomes dominant at high frequencies.)

Rated Value (□: packaging code)

Part Number	Impedance at 100MHz	Rated Current at 85°C	Rated Current at 125°C	DC Resistance
BLM02PX100SN1□	10Ω±5Ω	1.1A	850mA	0.05Ω
BLM02PX220SN1□	22Ω±25%	750mA	550mA	0.11Ω
BLM02PX330SN1□	33Ω±25%	550mA	400mA	0.2Ω
BLM02PX600SN1□	60Ω±25%	500mA	350mA	0.25Ω

Operating Temp. Range: -55°C to 125°C

Z-f characteristics

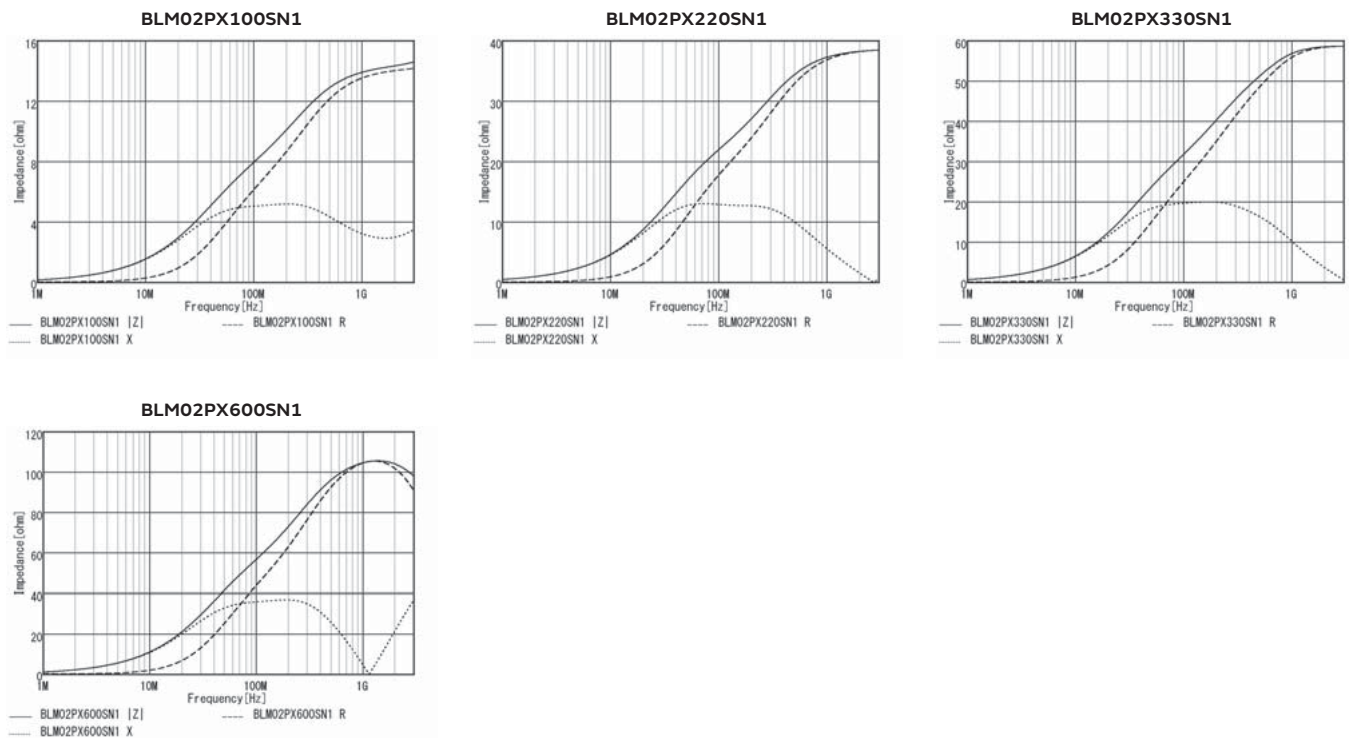

Continued on the following page. ↗

Continued from the preceding page. ↘

Derating of Rated Current

In operating temperature exceeding +85°C, derating of current is necessary for BLM02PX series.
Please apply the derating curve shown in chart according to the operating temperature.

Derating of Rated Current

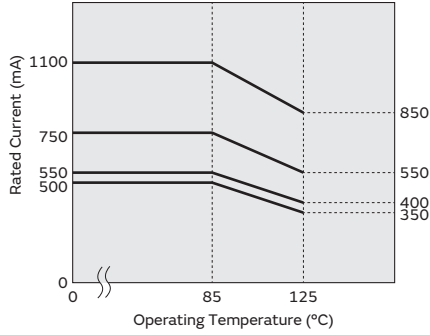

Chip ferrite bead

BLM02KX Series 01005/0402(inch/mm)

Appearance/Dimensions

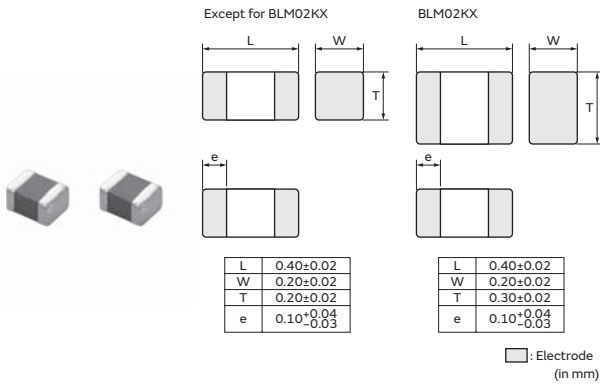

Packaging

Code	Packaging	Minimum Quantity
D	ø180mm Paper Tape	15000
B	Bulk(Bag)	1000

Equivalent Circuit

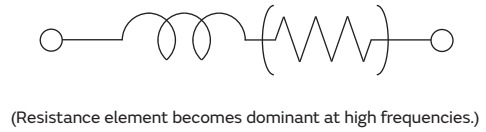

Rated Value (□: packaging code)

Part Number	Impedance at 100MHz	Rated Current at 85°C	Rated Current at 125°C	DC Resistance
BLM02KX100SN1□	10Ω±5Ω	1.5A	1.25A	0.03Ω
BLM02KX180SN1□	18Ω±25%	1.2A	950mA	0.045Ω

Operating Temp. Range: -55°C to 125°C

Z-f characteristics

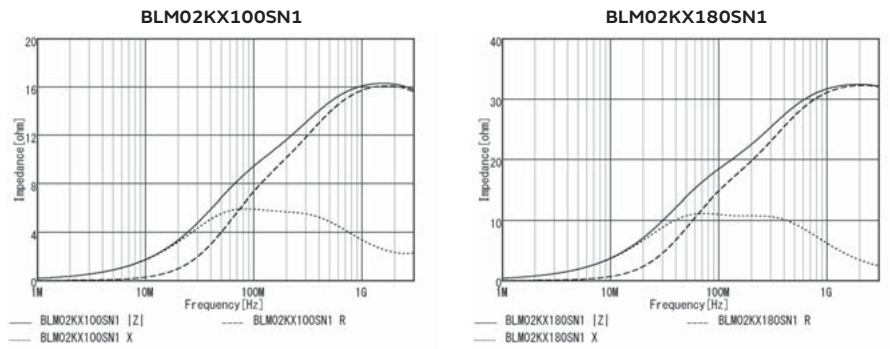

Derating of Rated Current

In operating temperature exceeding +85°C, derating of current is necessary for this series.
 Please apply the derating curve shown in chart according to the operating temperature.

Derating of Rated Current

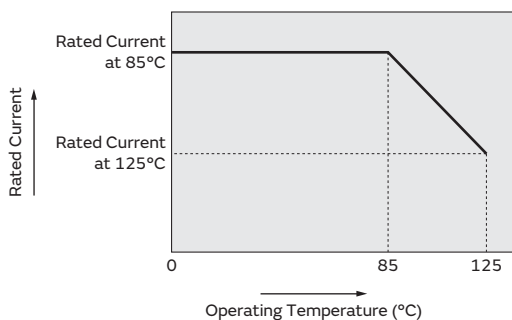

Chip ferrite bead

BLM02AX Series 01005/0402(inch/mm)

Appearance/Dimensions

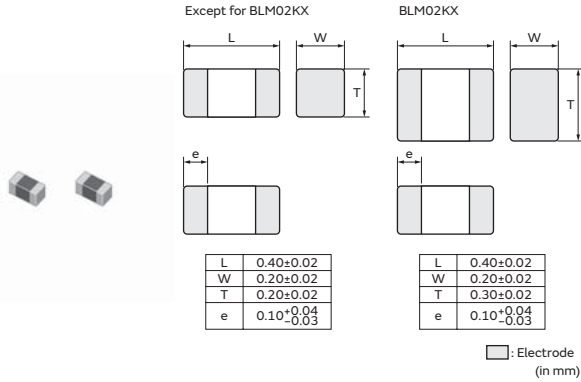

Packaging

Code	Packaging	Minimum Quantity
D	ø180mm Paper Tape	20000
B	Bulk(Bag)	1000

Equivalent Circuit



(Resistance element becomes dominant at high frequencies.)

Rated Value (□: packaging code)

Part Number	Impedance at 100MHz	Rated Current at 85°C	Rated Current at 125°C	DC Resistance
BLM02AX100SN1□	10Ω±5Ω	750mA	750mA	0.07Ω
BLM02AX700SN1□	70Ω±25%	300mA	300mA	0.36Ω
BLM02AX121SN1□	120Ω±25%	250mA	250mA	0.5Ω
BLM02AX241SN1□	240Ω±25%	200mA	200mA	0.9Ω

Operating Temp. Range: -55°C to 125°C

Z-f characteristics

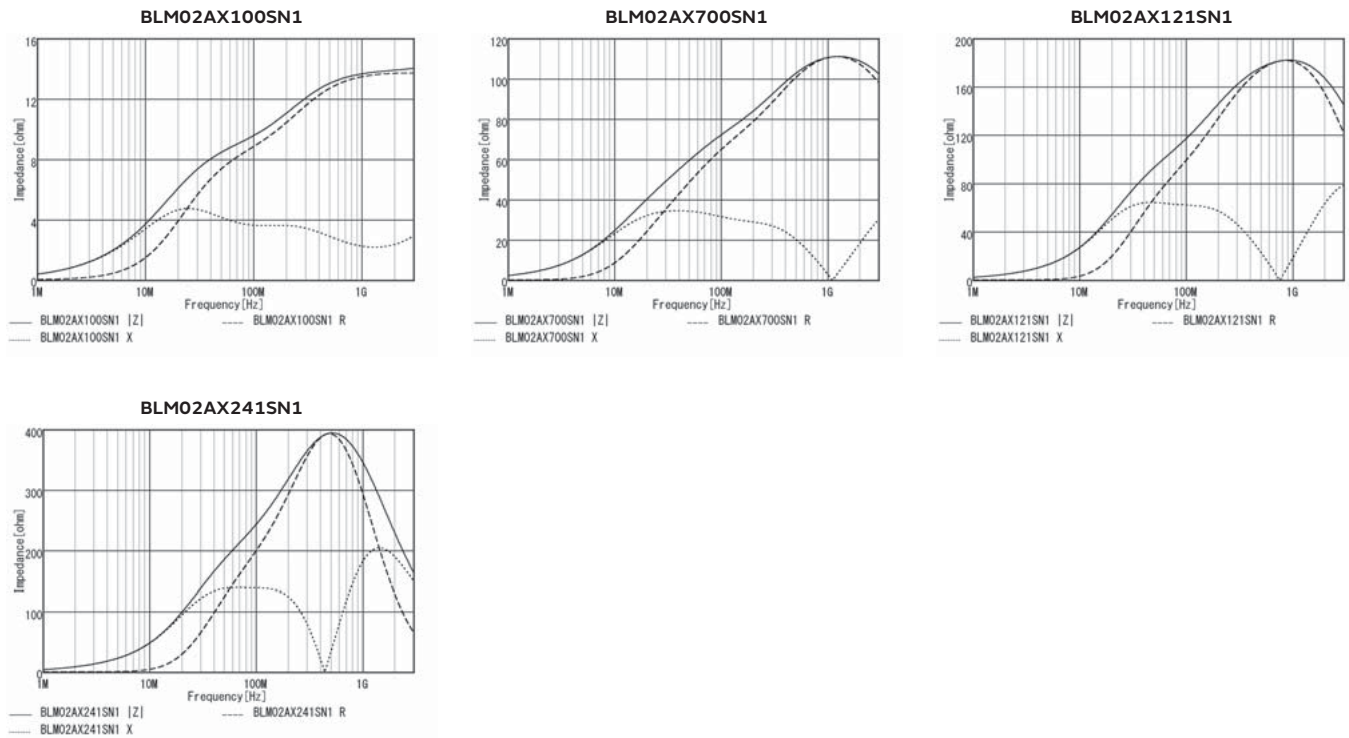

Chip Ferrite Bead (BLM□□AX Series) Feature Advantage

Excellent for Both Signal and Power Lines.
Multi Function Chip Ferrite Bead BLM□□AX Series

Feature

- 1/2 the DC resistance than conventional type utilizing the latest technology
 - New ferrite material
 - Optimum ferrite firing condition
 - Fine piling technology
 - Advanced coil pattern design technology
- Improved stability of performance at heat shock
- Wide line-up from 10 to 1000ohm(@100MHz) useful for signal line

Advantage

- High Rated Current
 - Good for miniaturization of high power equipment
- Lower Voltage down at Ferrite bead
 - Good for Battery driven equipment by saving running voltage margin
- Higher Reliability

Drastically Reduced DC Resistance

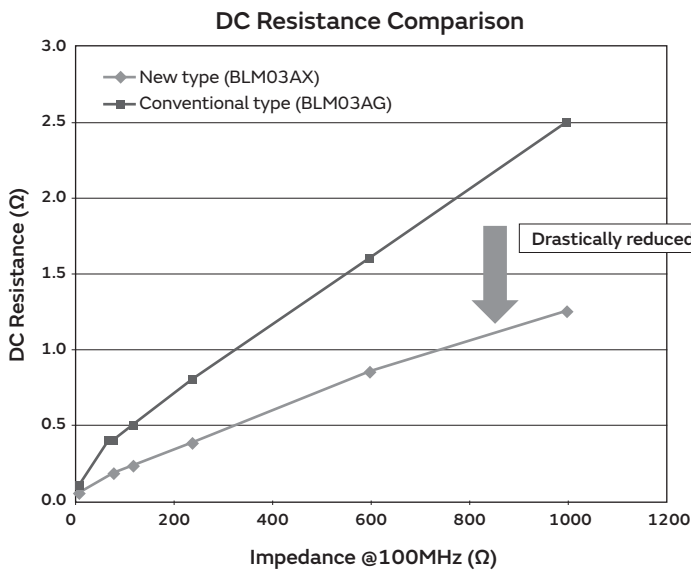

Test Result - Heat Shock

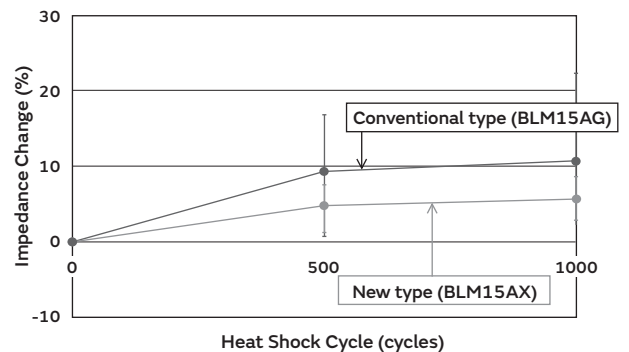

Chip Ferrite Bead
 Application Specified Noise Filter
 Chip EMIFIL®
 Common Mode Choke Coil
 Common Mode Noise Filter
 Block Type EMIFIL®
 EMC Absorber

Chip ferrite bead

BLM02BB/BC Series 01005/0402(inch/mm)

Appearance/Dimensions

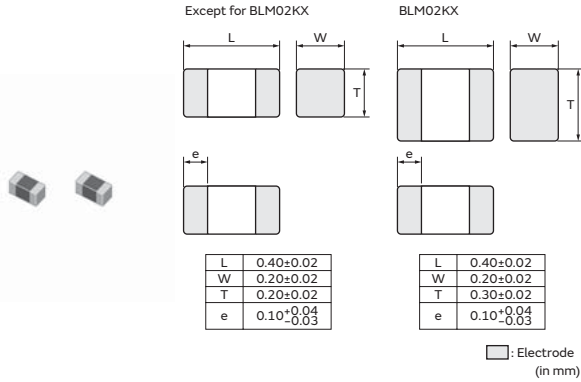

Packaging

BLM02BB101SN1 only

Code	Packaging	Minimum Quantity
D	ø180mm Paper Tape	20000
L	ø180mm Embossed Tape	40000

All except for BLM02BB101SN1

Code	Packaging	Minimum Quantity
D	ø180mm Paper Tape	20000
L	ø180mm Embossed Tape	40000
B	Bulk(Bag)	1000

Equivalent Circuit



(Resistance element becomes dominant at high frequencies.)

Rated Value (□: packaging code)

Part Number	Impedance at 100MHz	Impedance at 1GHz	Impedance at 2GHz	Rated Current at 85°C	Rated Current at 125°C	DC Resistance
BLM02BB101SN1□	100Ω±25%	-	-	125mA	125mA	2Ω
BLM02BC100SN1□	10Ω±5Ω	95Ω±50%	140Ω±50%	250mA	250mA	0.5Ω
BLM02BC220SN1□	22Ω±25%	240Ω±40%	340Ω±40%	200mA	200mA	0.9Ω

Operating Temp. Range: -55°C to 125°C

Z-f characteristics

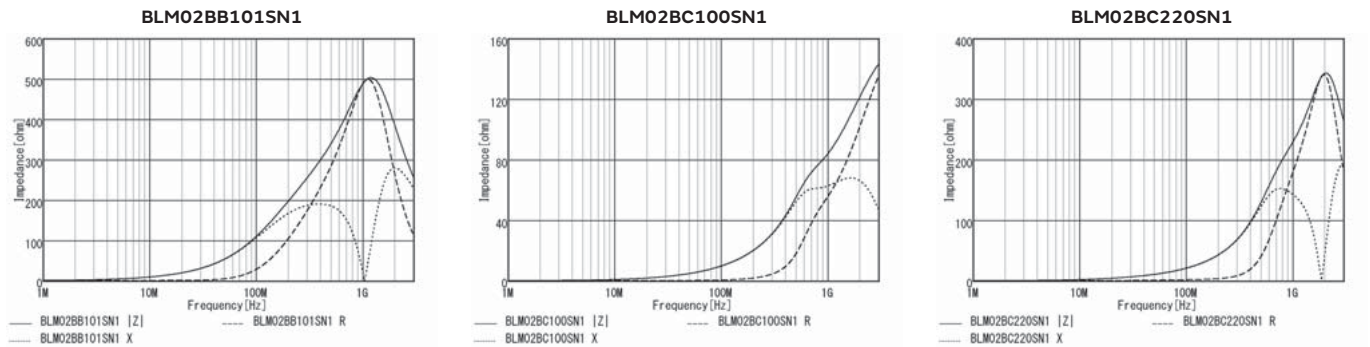

Chip ferrite bead

BLM02BX Series 01005/0402(inch/mm)

Appearance/Dimensions

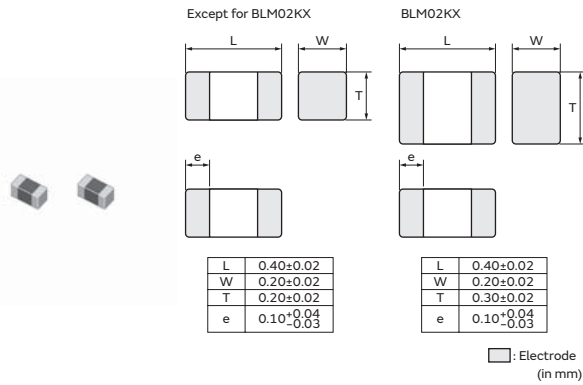

Packaging

Code	Packaging	Minimum Quantity
D	ø180mm Paper Tape	20000
B	Bulk(Bag)	1000

Equivalent Circuit



(Resistance element becomes dominant at high frequencies.)

Rated Value (□: packaging code)

Part Number	Impedance at 100MHz	Rated Current at 85°C	Rated Current at 125°C	DC Resistance
BLM02BX121SN1□	120Ω±25%	350mA	240mA	0.5Ω
BLM02BX151SN1□	150Ω±25%	280mA	200mA	0.7Ω
BLM02BX241SN1□	240Ω±25%	240mA	160mA	1.1Ω

Operating Temp. Range: -55°C to 125°C

Z-f characteristics

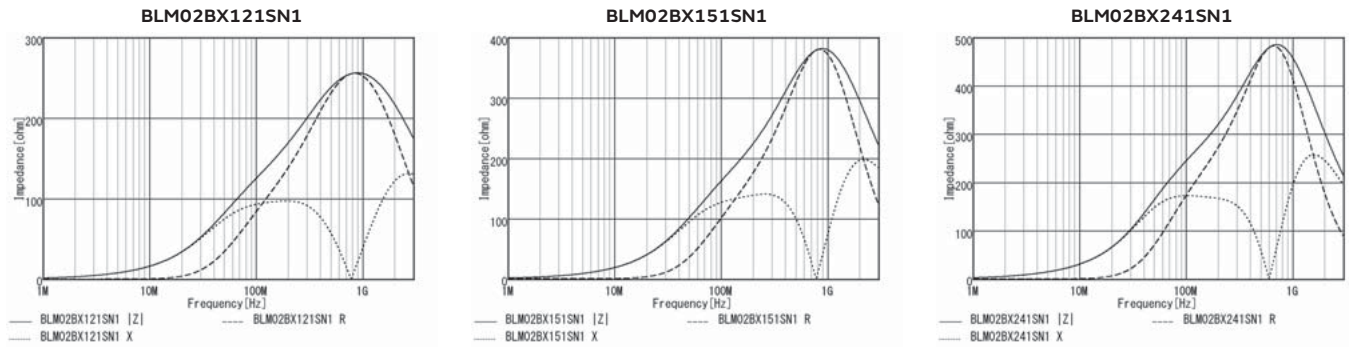

Derating of Rated Current

In operating temperature exceeding +85°C, derating of current is necessary for BLM02BX series. Please apply the derating curve shown in chart according to the operating temperature.

Derating of Rated Current

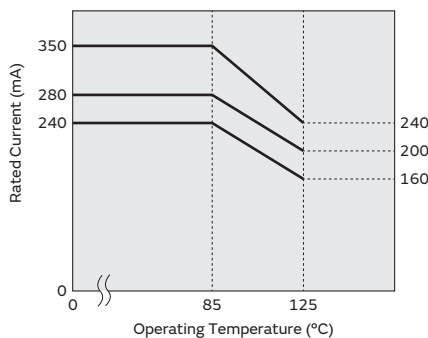

Chip ferrite bead

BLM03PG Series 0201/0603(inch/mm)

Appearance/Dimensions

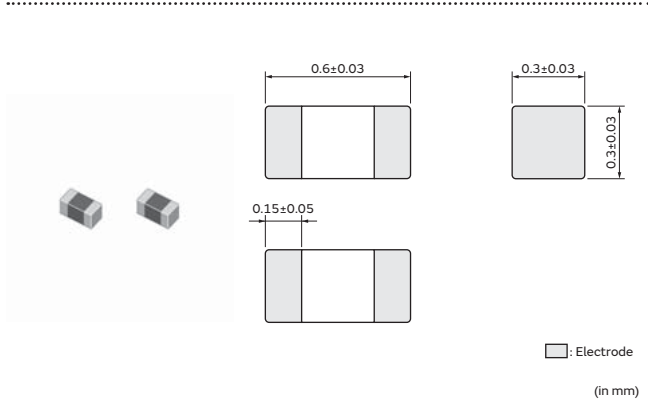

Packaging

Code	Packaging	Minimum Quantity
D	ø180mm Paper Tape	15000
J	ø330mm Paper Tape	50000
B	Bulk(Bag)	1000

Equivalent Circuit



(Resistance element becomes dominant at high frequencies.)

Rated Value (□: packaging code)

Part Number	Impedance at 100MHz	Rated Current at 85°C	Rated Current at 125°C	DC Resistance
BLM03PG220SN1□	22Ω±25%	900mA	900mA	0.065Ω
BLM03PG330SN1□	33Ω±25%	750mA	750mA	0.09Ω

Operating Temp. Range: -55°C to 125°C

Z-f characteristics

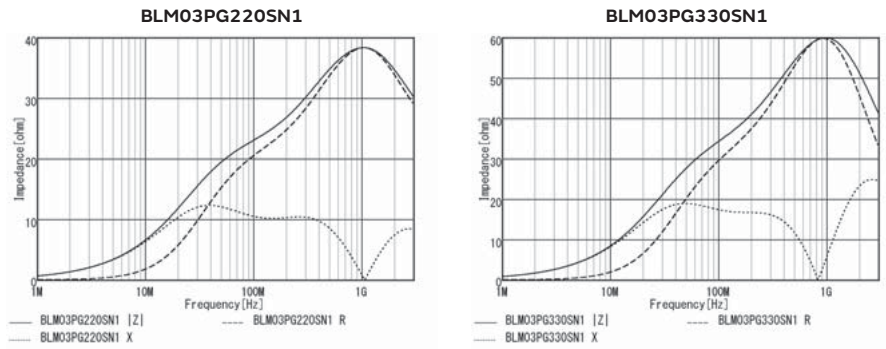

Chip ferrite bead

BLM03PX Series 0201/0603(inch/mm)

Appearance/Dimensions

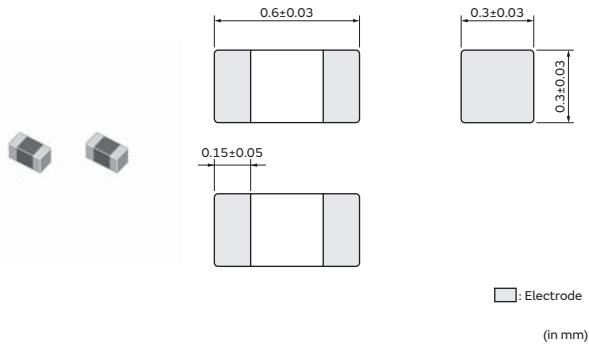

Packaging

Code	Packaging	Minimum Quantity
D	ø180mm Paper Tape	15000
J	ø330mm Paper Tape	50000
B	Bulk(Bag)	1000

Equivalent Circuit



(Resistance element becomes dominant at high frequencies.)

Rated Value (□: packaging code)

Part Number	Impedance at 100MHz	Rated Current at 85°C	Rated Current at 125°C	DC Resistance
BLM03PX220SN1□	22Ω±25%	1.8A	1.45A	0.04Ω
BLM03PX330SN1□	33Ω±25%	1.5A	1.2A	0.055Ω
BLM03PX800SN1□	80Ω±25%	1A	800mA	0.13Ω
BLM03PX121SN1□	120Ω±25%	900mA	700mA	0.16Ω

Operating Temp. Range: -55°C to 125°C

Z-f characteristics

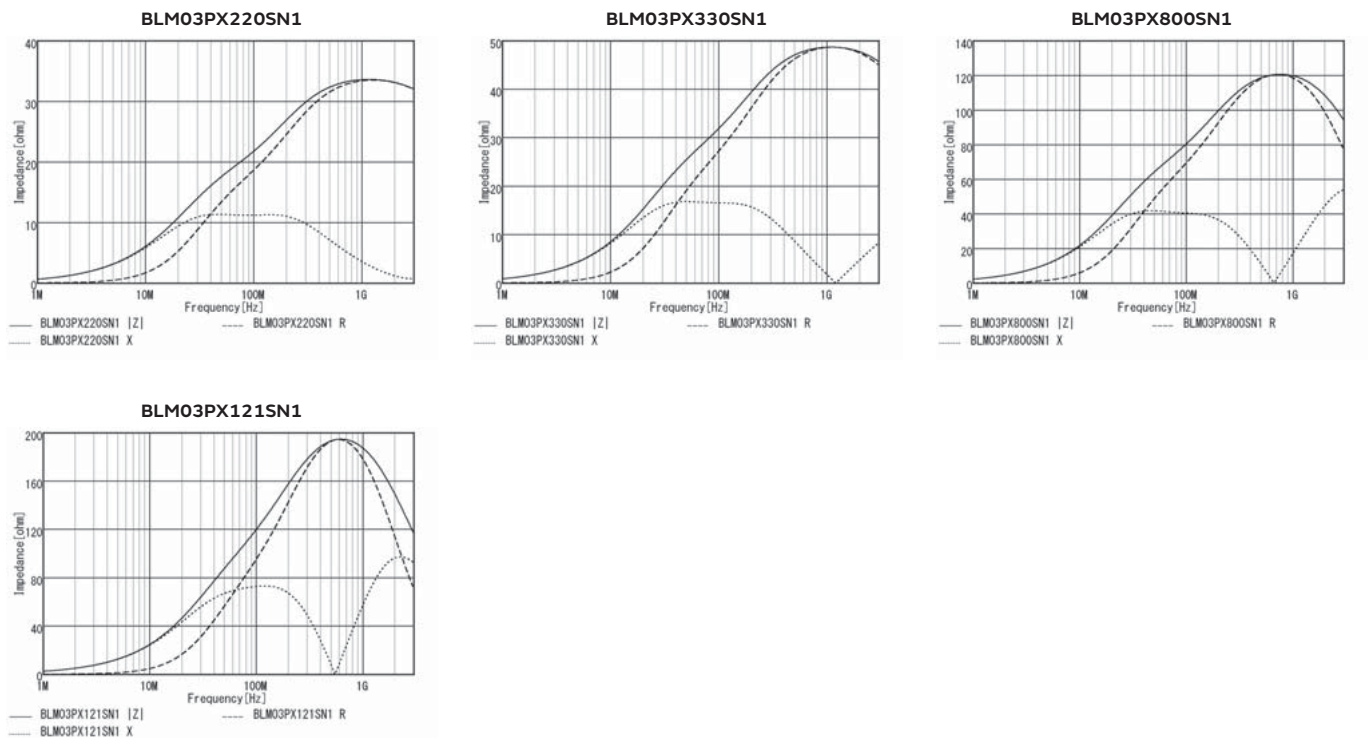

Continued on the following page. ↗

Continued from the preceding page. ↘

Derating of Rated Current

In operating temperature exceeding +85°C, derating of current is necessary for BLM03PX_S□1 series. Please apply the derating curve shown in chart according to the operating temperature.

Derating of Rated Current

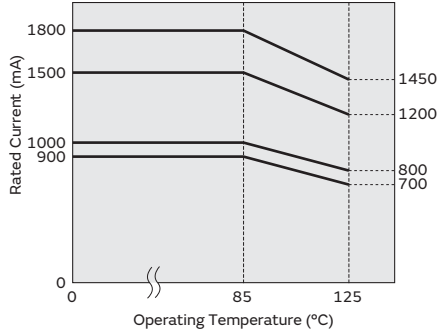

Chip ferrite bead

BLM03AG Series 0201/0603(inch/mm)

Appearance/Dimensions

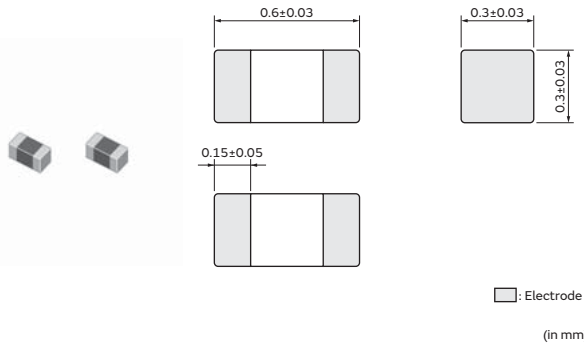

Packaging

Code	Packaging	Minimum Quantity
D	ø180mm Paper Tape	15000
J	ø330mm Paper Tape	50000
B	Bulk(Bag)	1000

Equivalent Circuit



(Resistance element becomes dominant at high frequencies.)

Rated Value (□: packaging code)

Part Number	Impedance at 100MHz	Rated Current at 85°C	Rated Current at 125°C	DC Resistance
BLM03AG100SN1□	10Ω(Typ.)	500mA	500mA	0.1Ω
BLM03AG700SN1□	70Ω(Typ.)	200mA	200mA	0.4Ω
BLM03AG800SN1□	80Ω±25%	200mA	200mA	0.4Ω
BLM03AG121SN1□	120Ω±25%	200mA	200mA	0.5Ω
BLM03AG241SN1□	240Ω±25%	200mA	200mA	0.8Ω
BLM03AG601SN1□	600Ω±25%	100mA	100mA	1.5Ω
BLM03AG102SN1□	1000Ω±25%	100mA	100mA	2.5Ω

Operating Temp. Range: -55°C to 125°C

Z-f characteristics

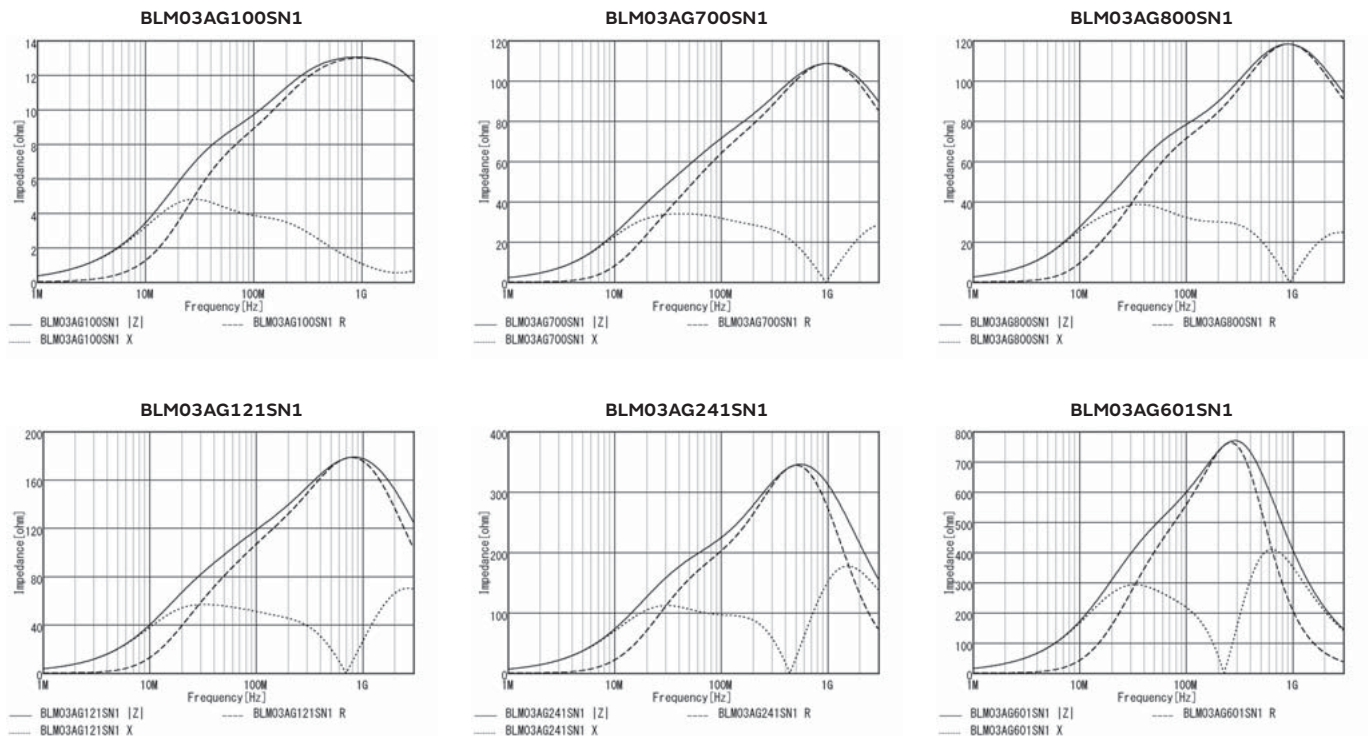

Continued on the following page. ↗

Chip Ferrite Bead
 Application Specified Noise Filter
 Chip EMIFIL®
 Common Mode Choke Coil
 Common Mode Noise Filter
 Block Type EMIFIL®
 EMC Absorber

Continued from the preceding page. ↘

Z-f characteristics

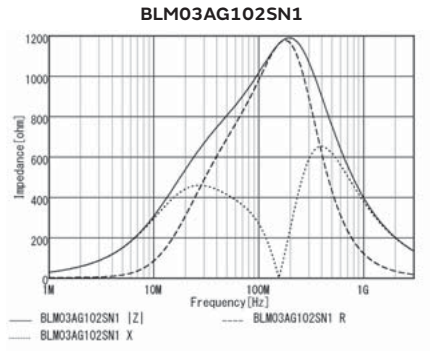

Chip Ferrite Bead

Application Specified Noise Filter

Chip EMIFIL®

Common Mode Choke Coil
 · Common Mode Noise Filter

Block Type EMIFIL®

EMC Absorber

Chip ferrite bead

BLM03AX Series 0201/0603(inch/mm)

Appearance/Dimensions

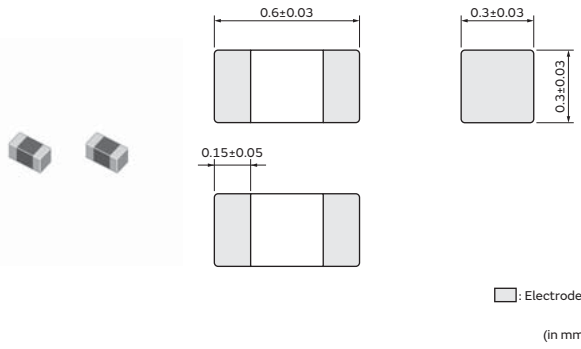

Packaging

Code	Packaging	Minimum Quantity
D	ø180mm Paper Tape	15000
J	ø330mm Paper Tape	50000
B	Bulk(Bag)	1000

Equivalent Circuit



(Resistance element becomes dominant at high frequencies.)

Rated Value (□: packaging code)

Part Number	Impedance at 100MHz	Rated Current at 85°C	Rated Current at 125°C	DC Resistance
BLM03AX100SN1□	10Ω(Typ.)	1A	1A	0.05Ω
BLM03AX800SN1□	80Ω±25%	500mA	500mA	0.18Ω
BLM03AX121SN1□	120Ω±25%	450mA	450mA	0.23Ω
BLM03AX241SN1□	240Ω±25%	350mA	350mA	0.38Ω
BLM03AX601SN1□	600Ω±25%	250mA	250mA	0.85Ω
BLM03AX102SN1□	1000Ω±25%	200mA	200mA	1.25Ω

Operating Temp. Range: -55°C to 125°C

Z-f characteristics

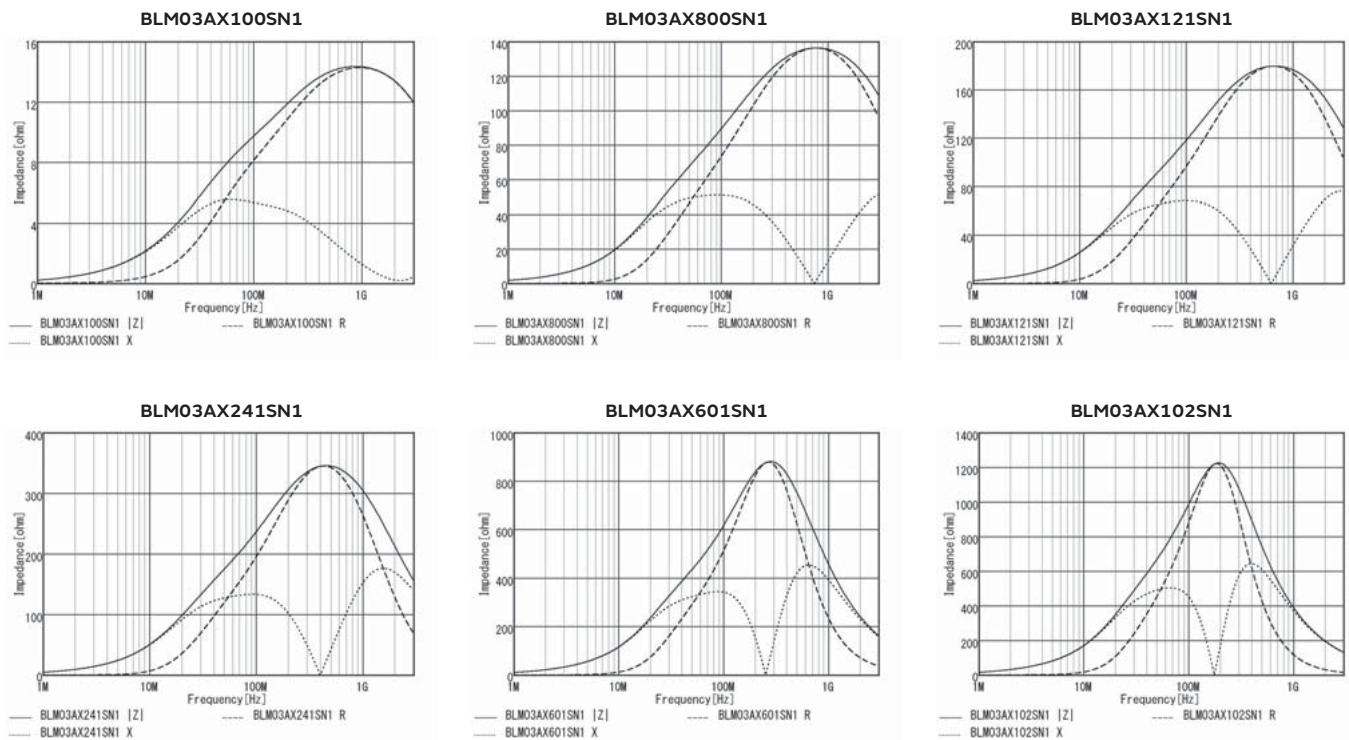

Chip ferrite bead

BLM03BB/BC/BD Series 0201/0603(inch/mm)

Appearance/Dimensions

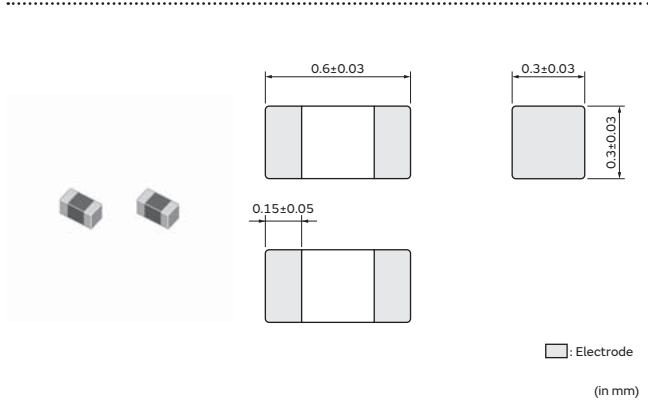

Packaging

Code	Packaging	Minimum Quantity
D	ø180mm Paper Tape	15000
J	ø330mm Paper Tape	50000
B	Bulk(Bag)	1000

Equivalent Circuit



(Resistance element becomes dominant at high frequencies.)

Rated Value (□: packaging code)

Part Number	Impedance at 100MHz	Rated Current at 85°C	Rated Current at 125°C	DC Resistance
BLM03BB100SN1□	10Ω±25%	300mA	300mA	0.4Ω
BLM03BB220SN1□	22Ω±25%	200mA	200mA	0.5Ω
BLM03BB470SN1□	47Ω±25%	200mA	200mA	0.7Ω
BLM03BB750SN1□	75Ω±25%	200mA	200mA	1Ω
BLM03BB121SN1□	120Ω±25%	100mA	100mA	1.5Ω
BLM03BC330SN1□	33Ω±25%	150mA	150mA	0.85Ω
BLM03BC560SN1□	56Ω±25%	100mA	100mA	1.05Ω
BLM03BC800SN1□	80Ω±25%	100mA	100mA	1.4Ω
BLM03BD750SN1□	75Ω±25%	300mA	300mA	0.4Ω
BLM03BD121SN1□	120Ω±25%	250mA	250mA	0.5Ω
BLM03BD241SN1□	240Ω±25%	200mA	200mA	0.8Ω
BLM03BD471SN1□	470Ω±25%	215mA	215mA	1.5Ω
BLM03BD601SN1□	600Ω±25%	200mA	200mA	1.7Ω

Operating Temp. Range: -55°C to 125°C

Z-f characteristics

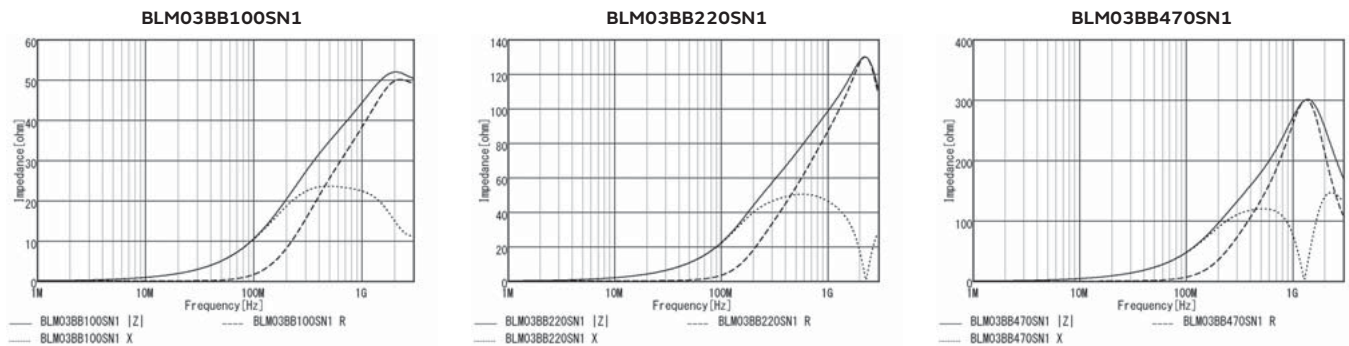

Continued on the following page. ↗

Continued from the preceding page. ↘

Z-f characteristics

BLM03BB750SN1

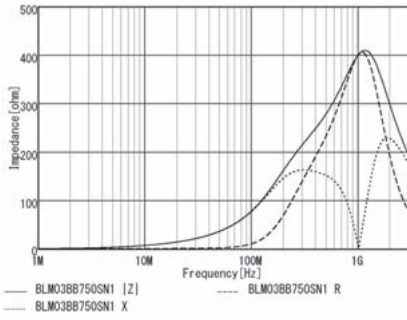

BLM03BB121SN1

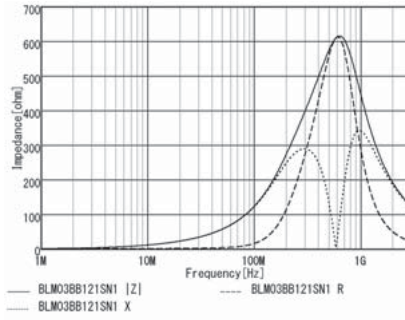

BLM03BC330SN1

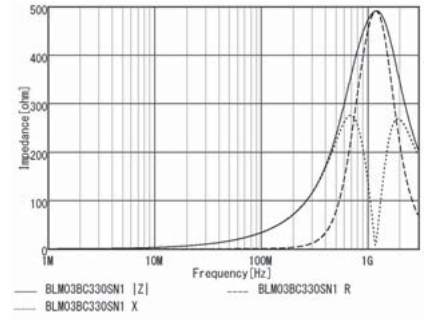

BLM03BC560SN1

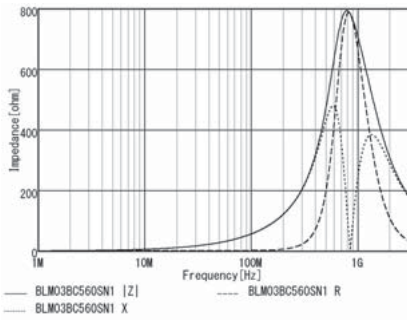

BLM03BC800SN1

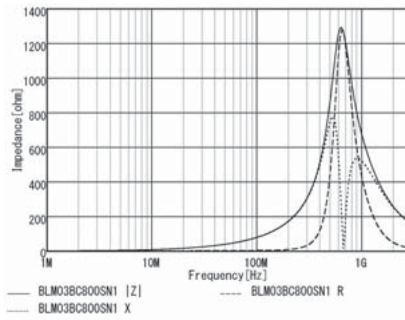

BLM03BD750SN1

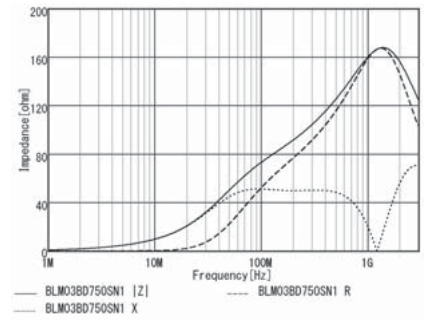

BLM03BD121SN1

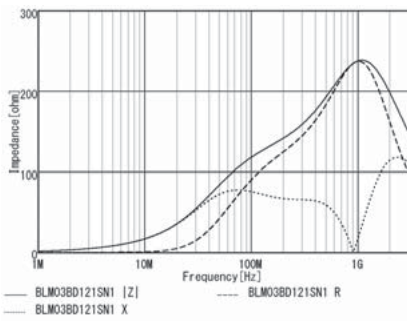

BLM03BD241SN1

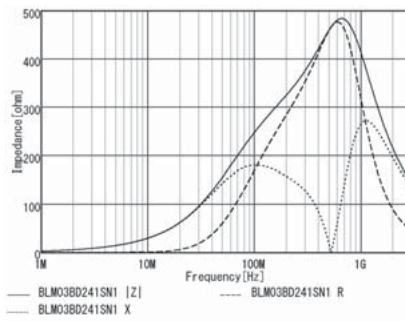

BLM03BD471SN1

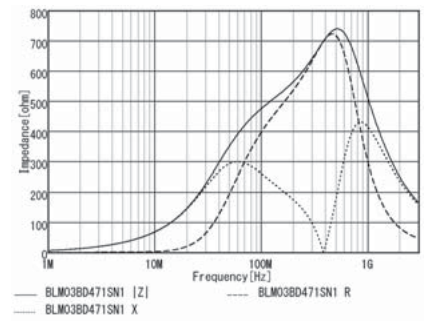

BLM03BD601SN1

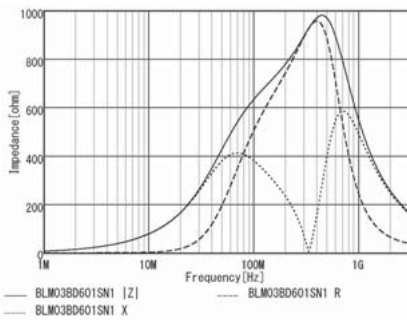

Chip ferrite bead

BLM03BX Series 0201/0603(inch/mm)

Appearance/Dimensions

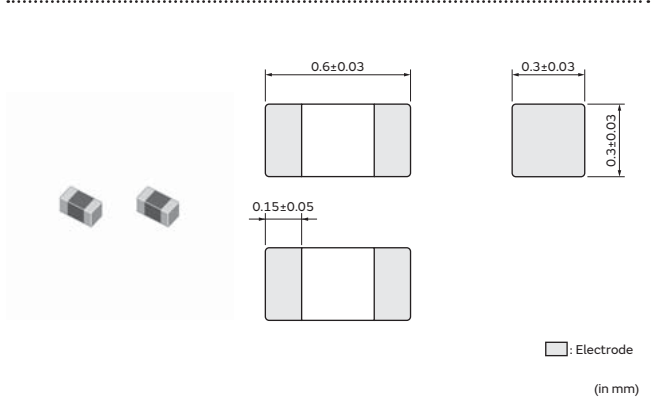

Packaging

Code	Packaging	Minimum Quantity
D	ø180mm Paper Tape	15000
J	ø330mm Paper Tape	50000
B	Bulk(Bag)	1000

Equivalent Circuit

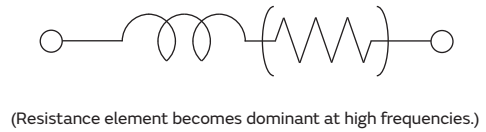

Rated Value (□: packaging code)

Part Number	Impedance at 100MHz	Rated Current at 85°C	Rated Current at 125°C	DC Resistance
BLM03BX102SN1□	1000Ω±25%	170mA	170mA	1.7Ω
BLM03BX182SN1□	1800Ω±25%	140mA	140mA	2.5Ω

Operating Temp. Range: -55°C to 125°C

Z-f characteristics

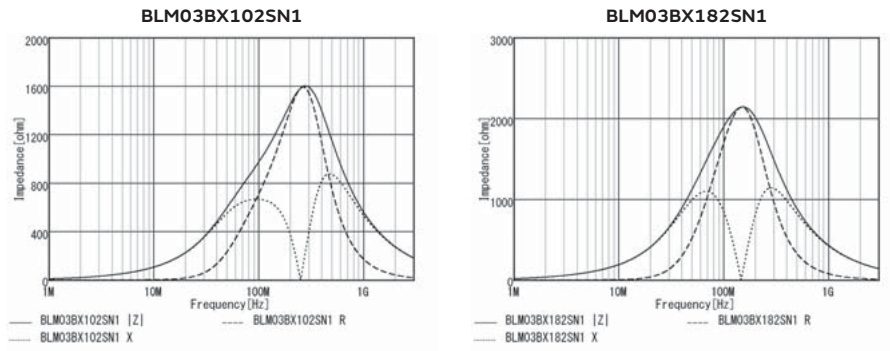

Chip ferrite bead

BLM15PD/PG Series 0402/1005(inch/mm)

Appearance/Dimensions

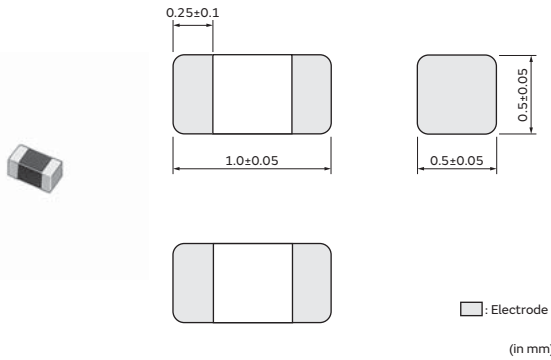

Packaging

Code	Packaging	Minimum Quantity
D	ø180mm Paper Tape	10000
J	ø330mm Paper Tape	50000
B	Bulk(Bag)	1000

Equivalent Circuit



(Resistance element becomes dominant at high frequencies.)

Rated Value (□: packaging code)

Part Number	Impedance at 100MHz	Rated Current at 85°C	Rated Current at 125°C	DC Resistance
BLM15PD300SN1□	30Ω±25%	2.2A	1.4A	0.035Ω
BLM15PD600SN1□	60Ω±25%	1.7A	1.1A	0.06Ω
BLM15PD800SN1□	80Ω±25%	1.5A	1A	0.07Ω
BLM15PD121SN1□	120Ω±25%	1.3A	900mA	0.09Ω
BLM15PG100SN1□	10Ω(Typ.)	1A	1A	0.025Ω

Operating Temp. Range: -55°C to 125°C

Z-f characteristics

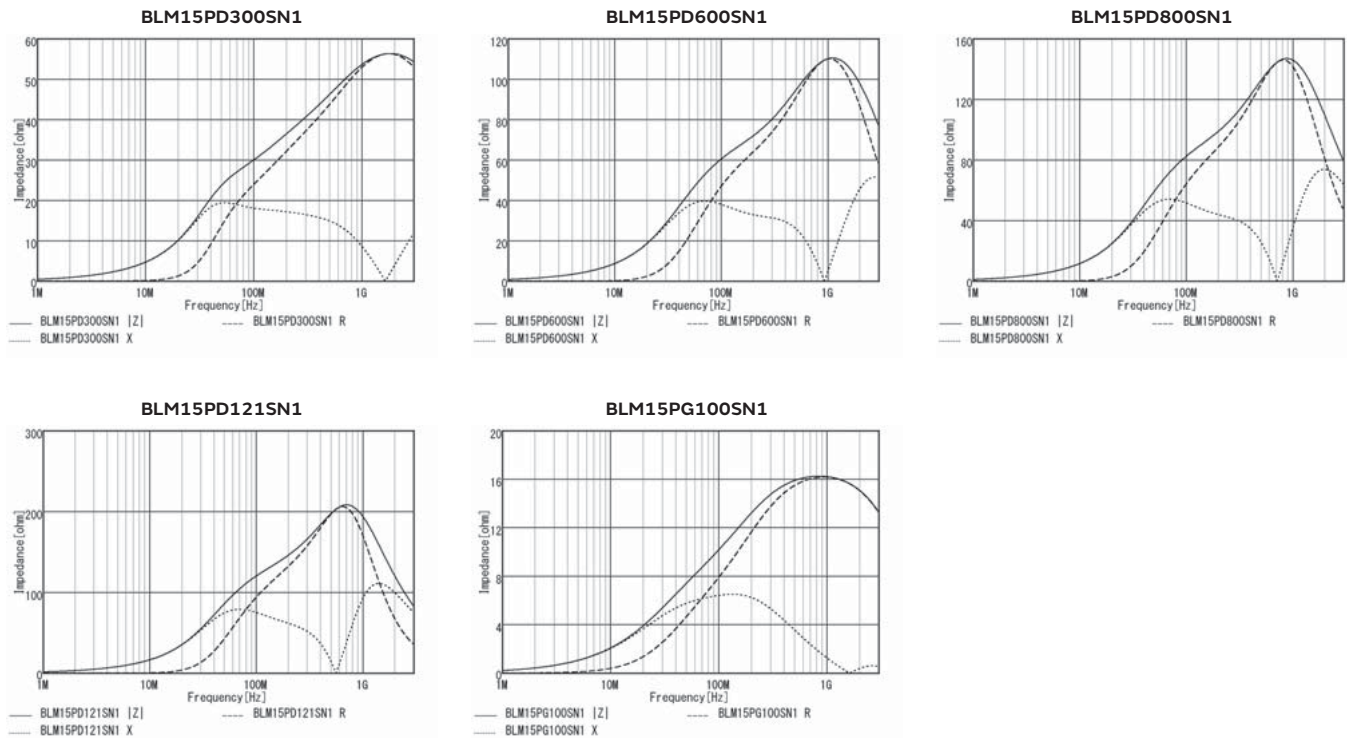

Continued on the following page. ↗

Continued from the preceding page. ↘

Derating of Rated Current

In operating temperature exceeding +85°C, derating of current is necessary for BLM15PD series.
 Please apply the derating curve shown in chart according to the operating temperature.

Derating of Rated Current

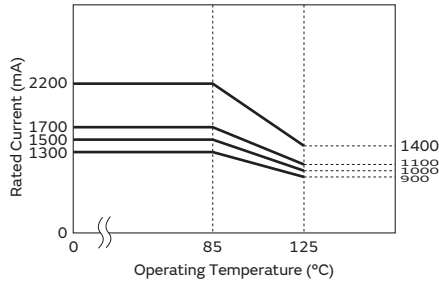

Chip ferrite bead

BLM15PX Series 0402/1005(inch/mm)

Appearance/Dimensions

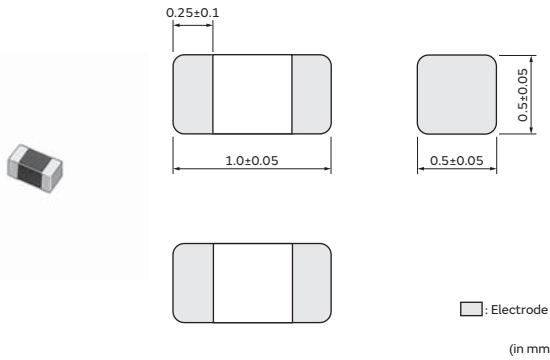

Packaging

Code	Packaging	Minimum Quantity
D	ø180mm Paper Tape	10000
J	ø330mm Paper Tape	50000
B	Bulk(Bag)	1000

Equivalent Circuit



(Resistance element becomes dominant at high frequencies.)

Rated Value (□: packaging code)

Part Number	Impedance at 100MHz	Rated Current at 85°C	Rated Current at 125°C	DC Resistance
BLM15PX330SN1□	$33\Omega \pm 25\%$	3A	1.7A	0.022Ω
BLM15PX600SN1□	$60\Omega \pm 25\%$	2.5A	1.4A	0.032Ω
BLM15PX800SN1□	$80\Omega \pm 25\%$	2.3A	1.3A	0.038Ω
BLM15PX121SN1□	$120\Omega \pm 25\%$	2A	1.1A	0.055Ω
BLM15PX181SN1□	$180\Omega \pm 25\%$	1.5A	800mA	0.09Ω
BLM15PX221SN1□	$220\Omega \pm 25\%$	1.4A	800mA	0.1Ω
BLM15PX331SN1□	$330\Omega \pm 25\%$	1.2A	700mA	0.15Ω
BLM15PX471SN1□	$470\Omega \pm 25\%$	1A	600mA	0.2Ω
BLM15PX601SN1□	$600\Omega \pm 25\%$	900mA	500mA	0.23Ω

Operating Temp. Range: -55°C to 125°C

Z-f characteristics

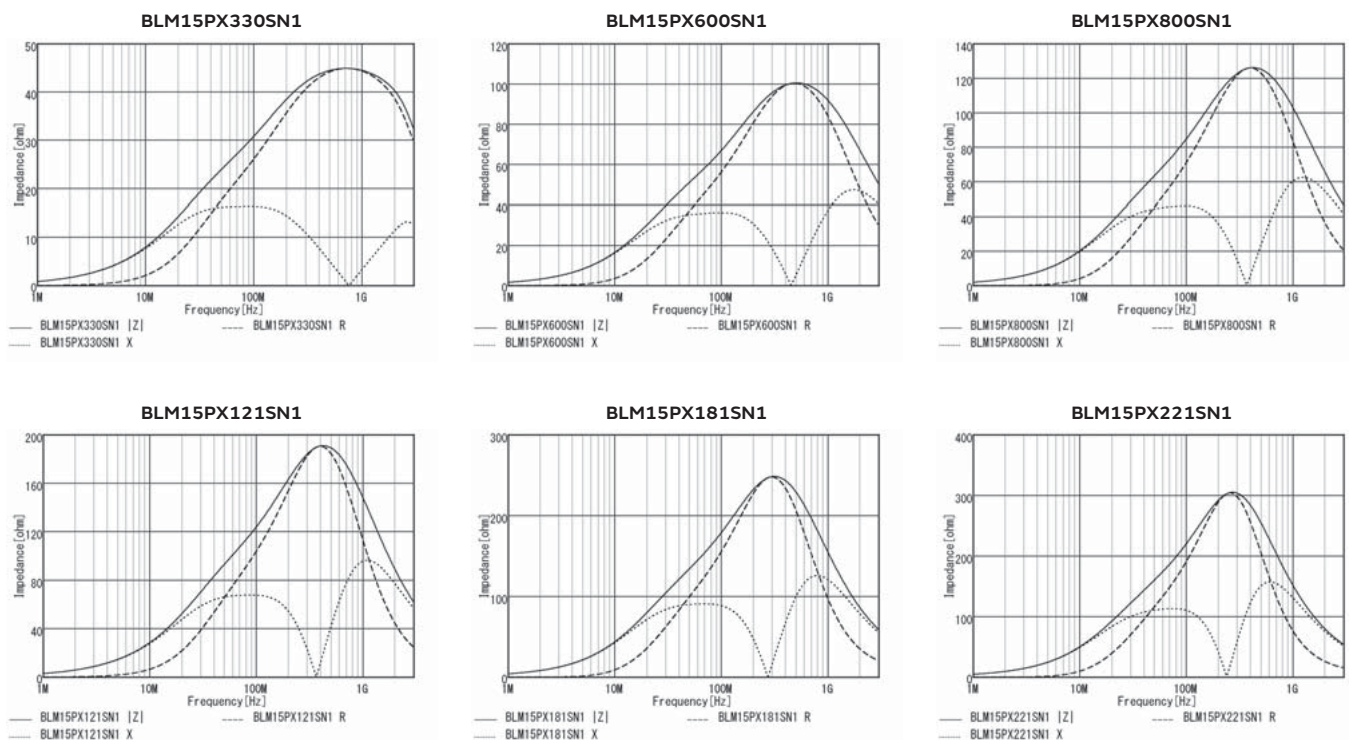

Continued from the preceding page. ↘

Z-f characteristics

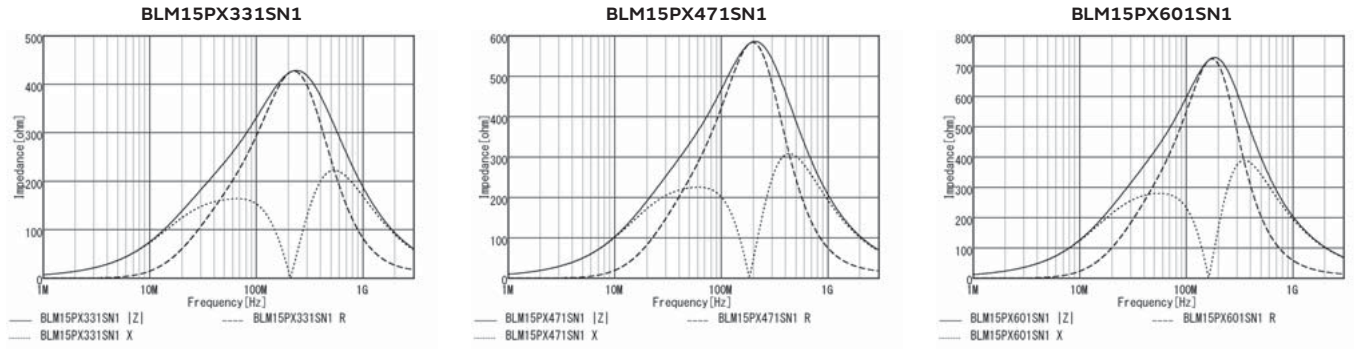

Derating of Rated Current

In operating temperature exceeding +85°C, derating of current is necessary for BLM15PX series. Please apply the derating curve shown in chart according to the operating temperature.

Derating of Rated Current

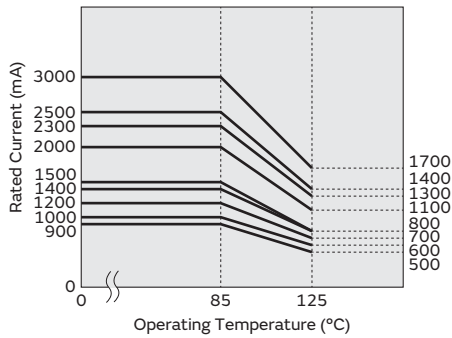

Chip ferrite bead

BLM15KD Series 0402/1005(inch/mm)

Appearance/Dimensions

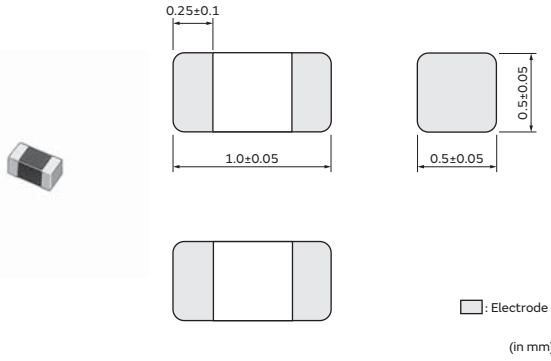

Packaging

Code	Packaging	Minimum Quantity
D	ø180mm Paper Tape	10000
J	ø330mm Paper Tape	50000
B	Bulk(Bag)	1000

Equivalent Circuit



(Resistance element becomes dominant at high frequencies.)

Rated Value (□: packaging code)

Part Number	Impedance at 100MHz	Rated Current at 85°C	Rated Current at 125°C	DC Resistance
BLM15KD200SN1□	20Ω±25%	3.8A	2.35A	0.011Ω
BLM15KD300SN1□	30Ω±25%	3.1A	1.9A	0.017Ω
BLM15KD121SN1□	120Ω±25%	1.5A	930mA	0.07Ω

Operating Temp. Range: -55°C to 125°C

Z-f characteristics

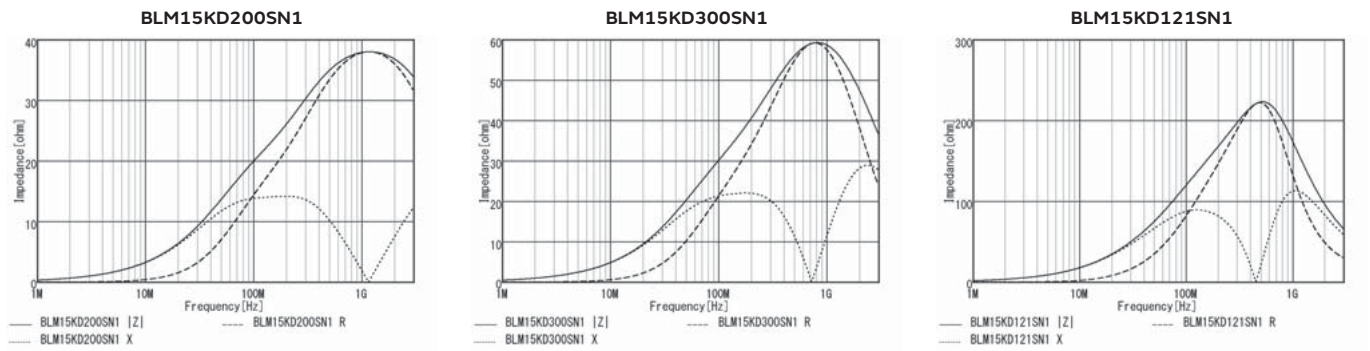

Derating of Rated Current

In operating temperature exceeding +85°C, derating of current is necessary for BLM15KD_SN1 series. Please apply the derating curve shown in chart according to the operating temperature.

Derating of Rated Current

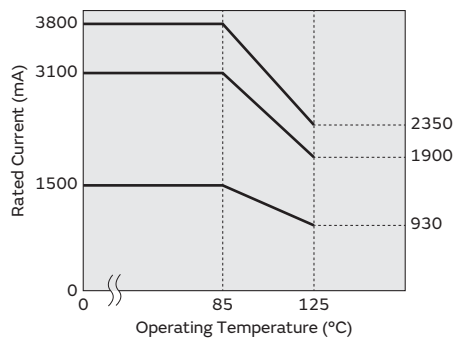

Chip ferrite bead

BLM15AG Series 0402/1005(inch/mm)

Appearance/Dimensions

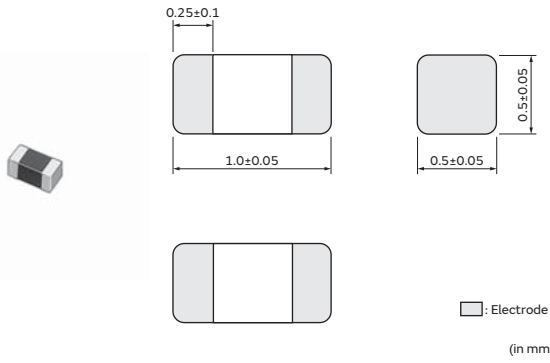

Packaging

Code	Packaging	Minimum Quantity
D	ø180mm Paper Tape	10000
J	ø330mm Paper Tape	50000
B	Bulk(Bag)	1000

Equivalent Circuit



(Resistance element becomes dominant at high frequencies.)

Rated Value (□: packaging code)

Part Number	Impedance at 100MHz	Rated Current at 85°C	Rated Current at 125°C	DC Resistance
BLM15AG100SN1□	10Ω(Typ.)	1A	1A	0.025Ω
BLM15AG700SN1□	70Ω(Typ.)	600mA	600mA	0.15Ω
BLM15AG121SN1□	120Ω±25%	550mA	550mA	0.19Ω
BLM15AG221SN1□	220Ω±25%	450mA	450mA	0.29Ω
BLM15AG601SN1□	600Ω±25%	300mA	300mA	0.52Ω
BLM15AG102SN1□	1000Ω±25%	300mA	300mA	0.65Ω

Operating Temp. Range: -55°C to 125°C

Z-f characteristics

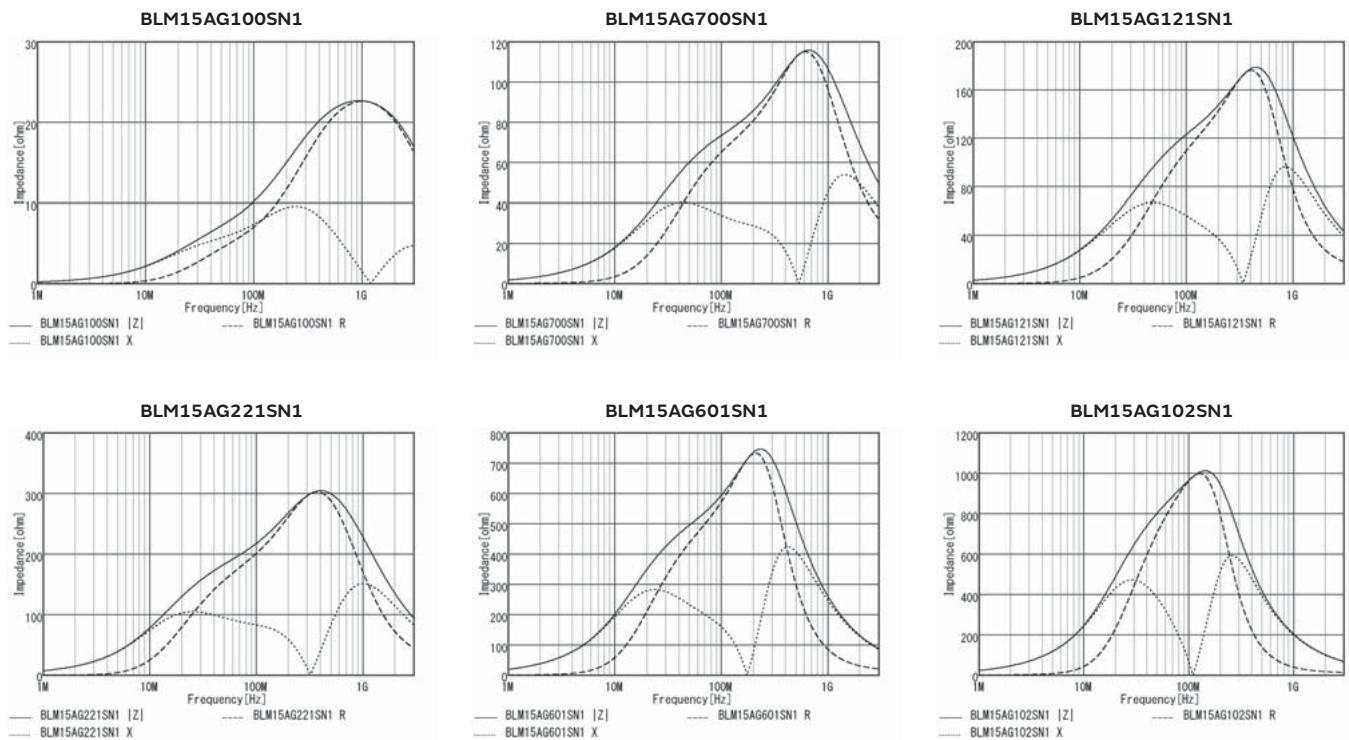

Chip ferrite bead

BLM15AX Series 0402/1005(inch/mm)

Appearance/Dimensions

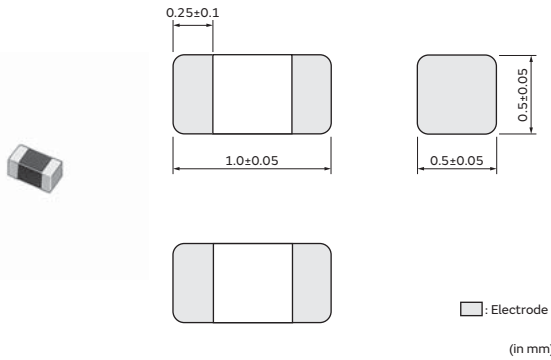

Packaging

Code	Packaging	Minimum Quantity
D	ø180mm Paper Tape	10000
J	ø330mm Paper Tape	50000
B	Bulk(Bag)	1000

Equivalent Circuit



(Resistance element becomes dominant at high frequencies.)

Rated Value (□: packaging code)

Part Number	Impedance at 100MHz	Rated Current at 85°C	Rated Current at 125°C	DC Resistance
BLM15AX100SN1□	10Ω±5%	1.74A	1.74A	0.015Ω
BLM15AX300SN1□	30Ω±25%	1.1A	1.1A	0.06Ω
BLM15AX700SN1□	70Ω±25%	780mA	780mA	0.1Ω
BLM15AX121SN1□	120Ω±25%	700mA	700mA	0.13Ω
BLM15AX221SN1□	220Ω±25%	600mA	600mA	0.18Ω
BLM15AX601SN1□	600Ω±25%	500mA	500mA	0.34Ω
BLM15AX102SN1□	1000Ω±25%	350mA	350mA	0.49Ω

Operating Temp. Range: -55°C to 125°C

Z-f characteristics

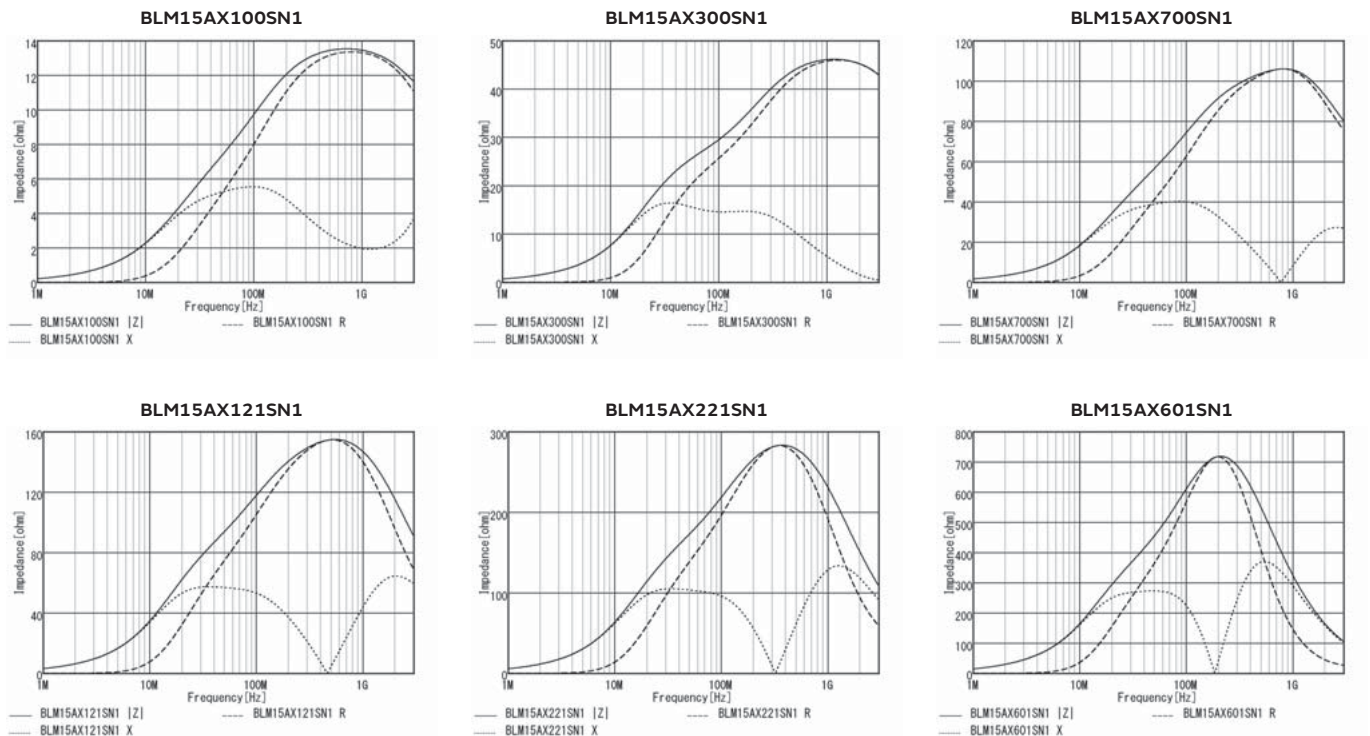

Continued on the following page. ↗

Continued from the preceding page. ↘

Z-f characteristics

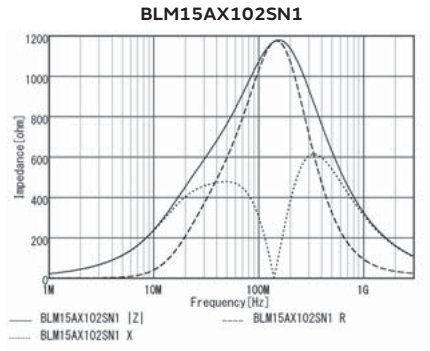

Chip ferrite bead

BLM15BA/BB/BC/BD Series 0402/1005(inch/mm)

Appearance/Dimensions

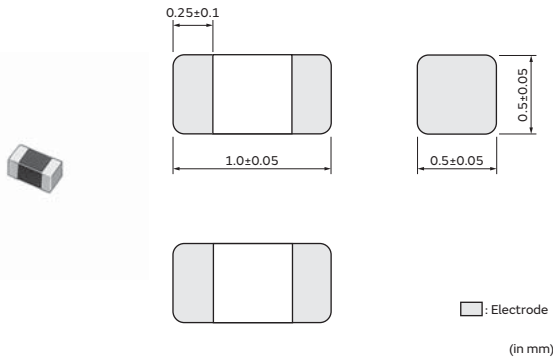

Packaging

Code	Packaging	Minimum Quantity
D	ø180mm Paper Tape	10000
J	ø330mm Paper Tape	50000
B	Bulk(Bag)	1000

Equivalent Circuit



(Resistance element becomes dominant at high frequencies.)

Rated Value (□: packaging code)

Part Number	Impedance at 100MHz	Rated Current at 85°C	Rated Current at 125°C	DC Resistance
BLM15BA050SN1□	5Ω±25%	300mA	300mA	0.1Ω
BLM15BA100SN1□	10Ω±25%	300mA	300mA	0.2Ω
BLM15BA220SN1□	22Ω±25%	300mA	300mA	0.3Ω
BLM15BA330SN1□	33Ω±25%	300mA	300mA	0.4Ω
BLM15BA470SN1□	47Ω±25%	200mA	200mA	0.6Ω
BLM15BA750SN1□	75Ω±25%	200mA	200mA	0.8Ω
BLM15BB050SN1□	5Ω±25%	500mA	500mA	0.08Ω
BLM15BB100SN1□	10Ω±25%	300mA	300mA	0.1Ω
BLM15BB220SN1□	22Ω±25%	300mA	300mA	0.2Ω
BLM15BB470SN1□	47Ω±25%	300mA	300mA	0.35Ω
BLM15BB750SN1□	75Ω±25%	300mA	300mA	0.4Ω
BLM15BB121SN1□	120Ω±25%	300mA	300mA	0.55Ω
BLM15BB221SN1□	220Ω±25%	200mA	200mA	0.8Ω
BLM15BC121SN1□	120Ω±25%	350mA	350mA	0.45Ω
BLM15BC241SN1□	240Ω±25%	250mA	250mA	0.7Ω
BLM15BD750SN1□	75Ω±25%	300mA	300mA	0.2Ω
BLM15BD121SN1□	120Ω±25%	300mA	300mA	0.3Ω
BLM15BD221SN1□	220Ω±25%	300mA	300mA	0.4Ω
BLM15BD471SN1□	470Ω±25%	200mA	200mA	0.6Ω
BLM15BD601SN1□	600Ω±25%	200mA	200mA	0.65Ω
BLM15BD102SN1□	1000Ω±25%	200mA	200mA	0.9Ω
BLM15BD152SN1□	1500Ω±25%	190mA	190mA	1Ω
BLM15BD182SN1□	1800Ω±25%	100mA	100mA	1.4Ω

Operating Temp. Range: -55°C to 125°C

Continued on the following page. ↗

Continued from the preceding page. ↘

Z-f characteristics

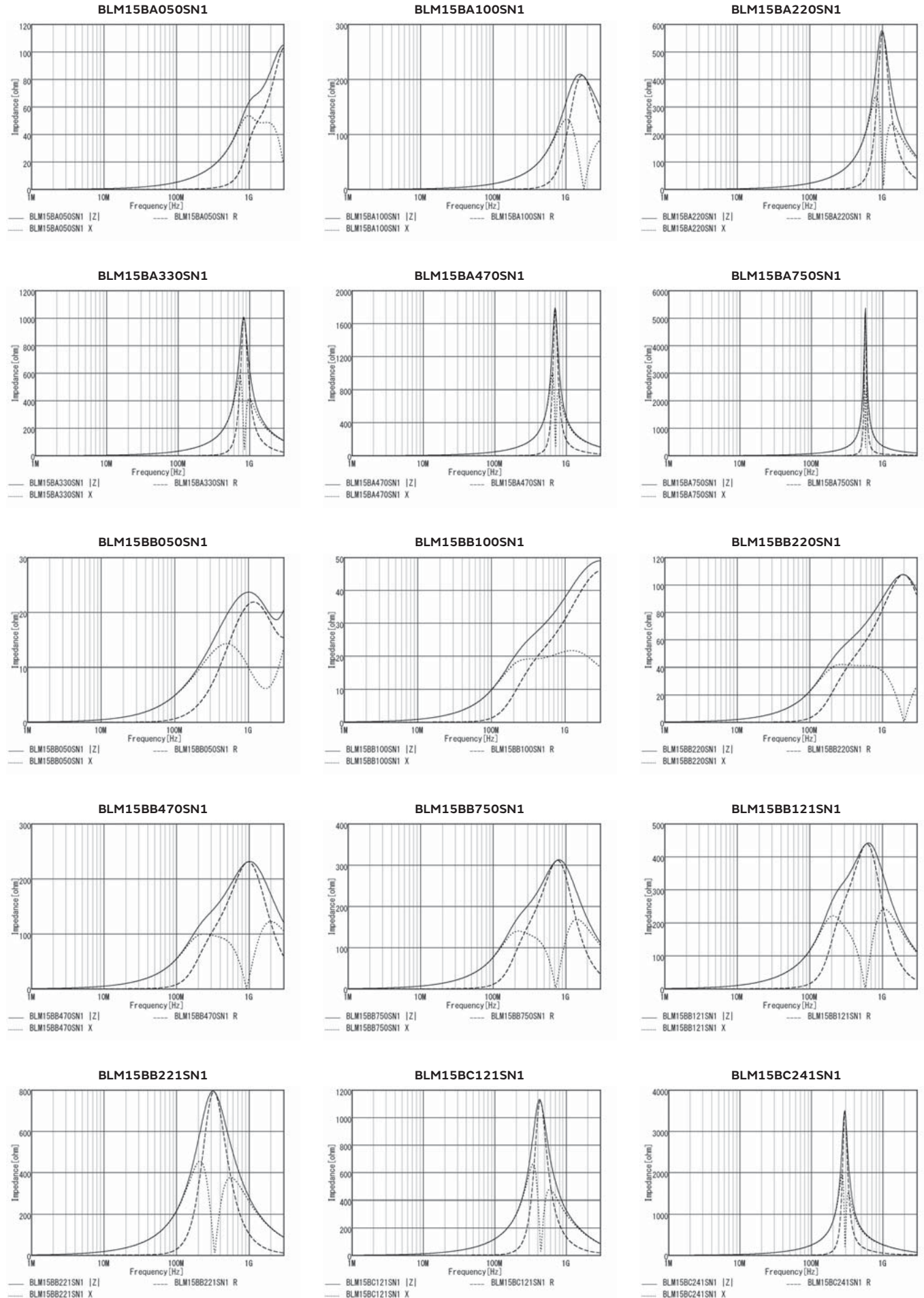

Continued from the preceding page. ↘

Z-f characteristics

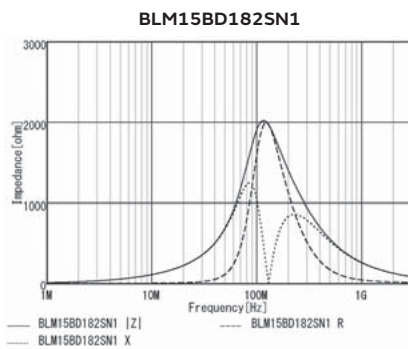
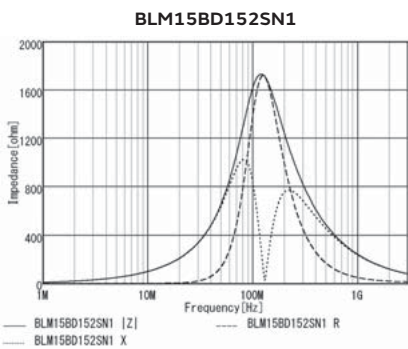
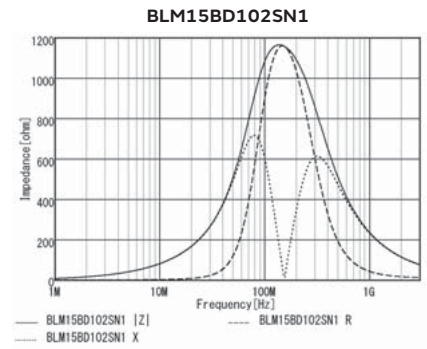
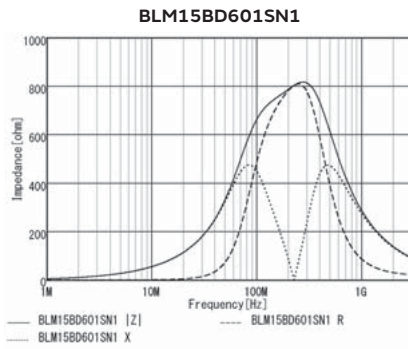
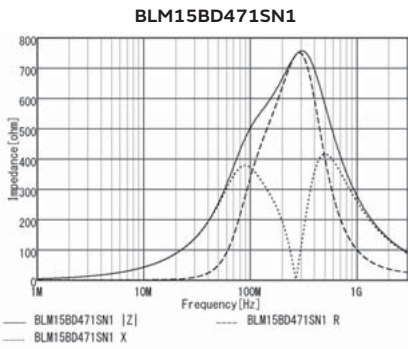
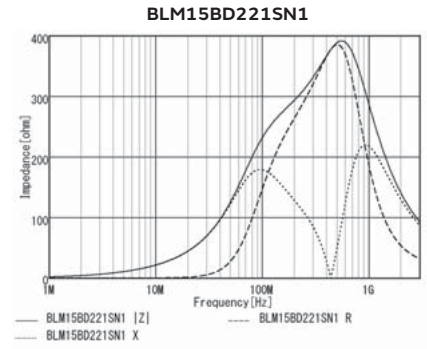
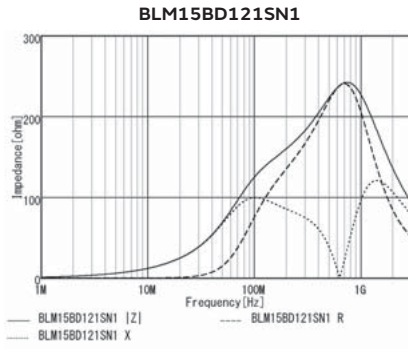
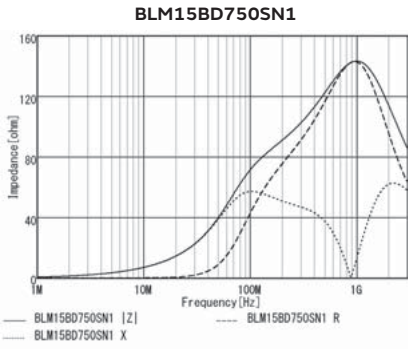

Chip Ferrite Bead

Application Specified Noise Filter

Chip EMIFIL®

Common Mode Choke Coil
 Common Mode Noise Filter

Block Type EMIFIL®

EMC Absorber

Chip ferrite bead

BLM15BX Series 0402/1005(inch/mm)

Appearance/Dimensions

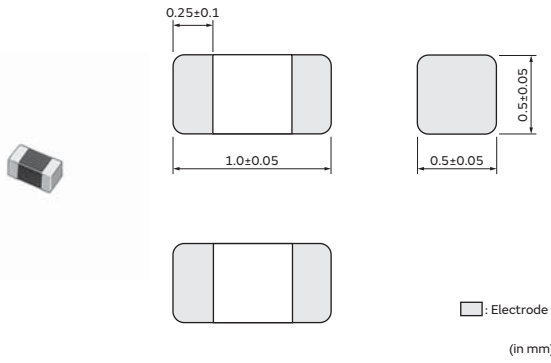

Packaging

Code	Packaging	Minimum Quantity
D	ø180mm Paper Tape	10000
J	ø330mm Paper Tape	50000
B	Bulk(Bag)	1000

Equivalent Circuit



(Resistance element becomes dominant at high frequencies.)

Rated Value (□: packaging code)

Part Number	Impedance at 100MHz	Rated Current at 85°C	Rated Current at 125°C	DC Resistance
BLM15BX750SN1□	75Ω±25%	600mA	600mA	0.15Ω
BLM15BX121SN1□	120Ω±25%	600mA	600mA	0.17Ω
BLM15BX221SN1□	220Ω±25%	450mA	450mA	0.27Ω
BLM15BX471SN1□	470Ω±25%	350mA	350mA	0.41Ω
BLM15BX601SN1□	600Ω±25%	350mA	350mA	0.46Ω
BLM15BX102SN1□	1000Ω±25%	300mA	300mA	0.65Ω
BLM15BX182SN1□	1800Ω±25%	250mA	250mA	0.9Ω

Operating Temp. Range: -55°C to 125°C

Z-f characteristics

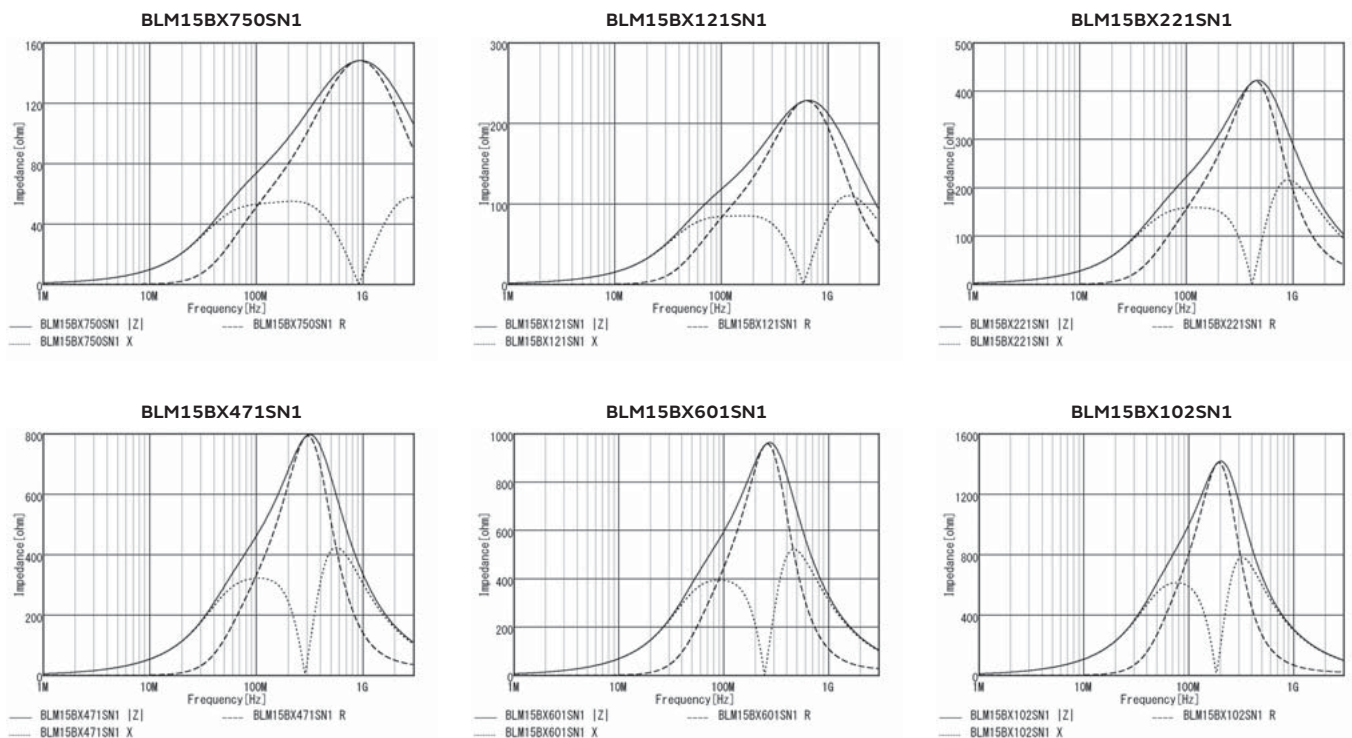

Continued on the following page. ↗

Continued from the preceding page. ↘

Z-f characteristics

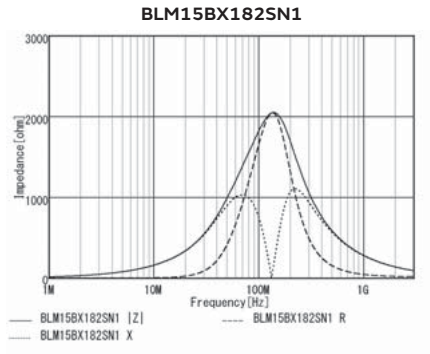

Chip Ferrite Bead

Application Specified Noise Filter

Chip EMIFIL®

Common Mode Choke Coil
Common Mode Noise Filter

Block Type EMIFIL®

EMC Absorber

Chip ferrite bead

BLM18PG Series 0603/1608(inch/mm)

Appearance/Dimensions

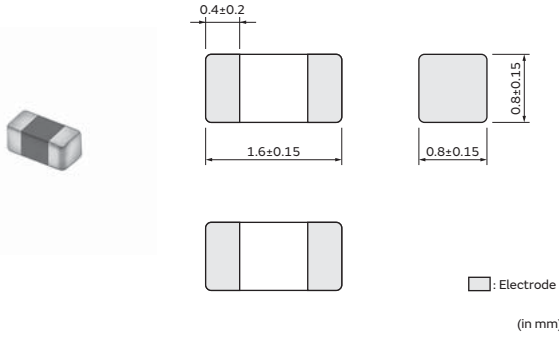

Packaging

Code	Packaging	Minimum Quantity
D	ø180mm Paper Tape	4000
J	ø330mm Paper Tape	10000
B	Bulk(Bag)	1000

Equivalent Circuit



(Resistance element becomes dominant at high frequencies.)

Rated Value (□: packaging code)

Part Number	Impedance at 100MHz	Rated Current at 85°C	Rated Current at 125°C	DC Resistance
BLM18PG300SN1□	30Ω(Typ.)	1A	1A	0.05Ω
BLM18PG330SN1□	33Ω±25%	3A	1A	0.025Ω
BLM18PG600SN1□	60Ω(Typ.)	1A	1A	0.1Ω
BLM18PG121SN1□	120Ω±25%	2A	1A	0.05Ω
BLM18PG181SN1□	180Ω±25%	1.5A	1A	0.09Ω
BLM18PG221SN1□	220Ω±25%	1.4A	1A	0.1Ω
BLM18PG331SN1□	330Ω±25%	1.2A	1A	0.15Ω
BLM18PG471SN1□	470Ω±25%	1A	1A	0.2Ω

Operating Temp. Range: -55°C to 125°C

Z-f characteristics

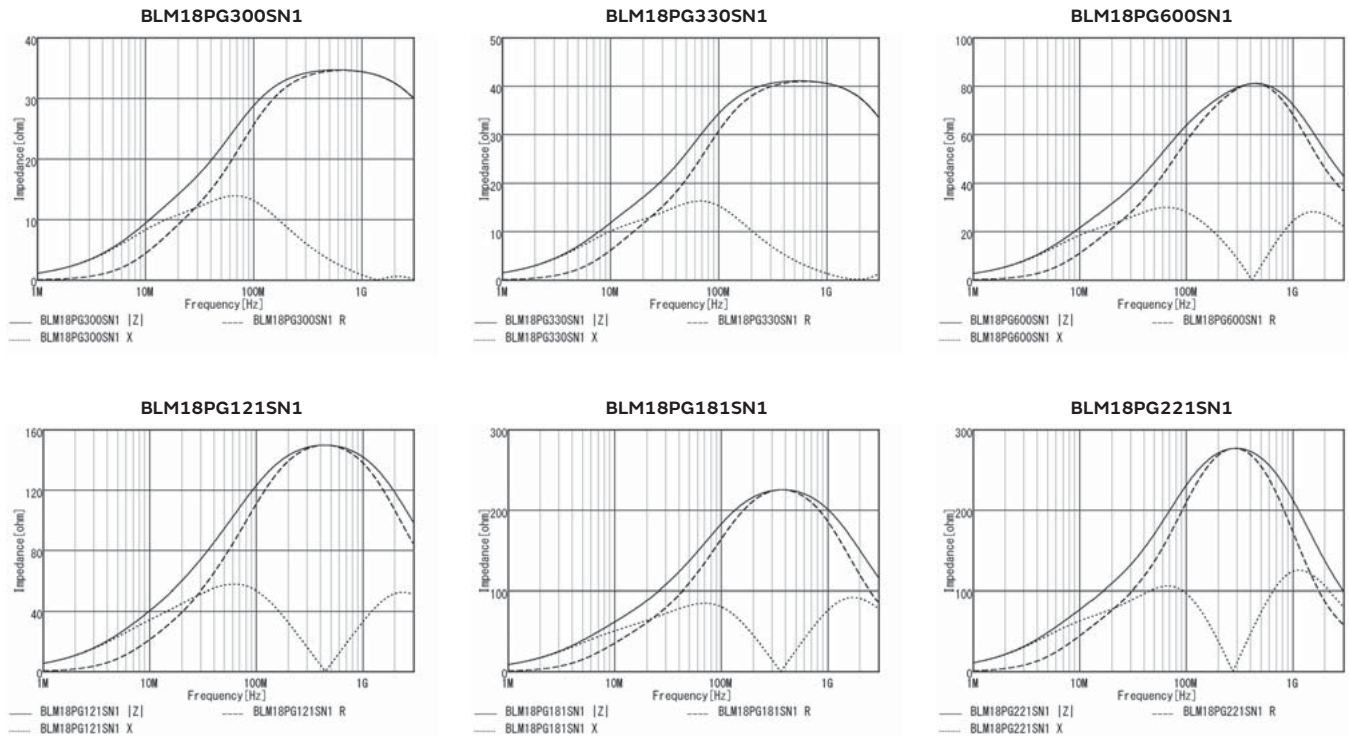

Continued on the following page. ↗

Continued from the preceding page. ↘

Z-f characteristics

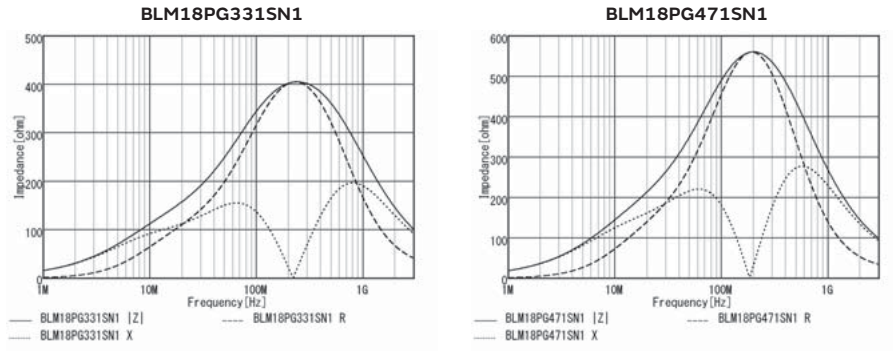

Derating of Rated Current

In operating temperature exceeding +85°C, derating of current is necessary for BLM18PG series.
 Please apply the derating curve shown in chart according to the operating temperature.

Derating of Rated Current

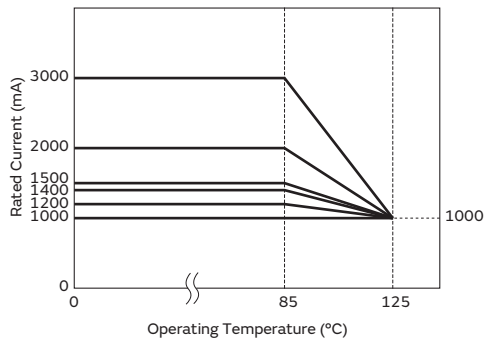

Chip Ferrite Bead

Application Specified Noise Filter

Chip EMIFIL®

Common Mode Choke Coil
 Common Mode Noise Filter

Block Type EMIFIL®

EMC Absorber

Chip ferrite bead

BLM18KG Series 0603/1608(inch/mm)

Appearance/Dimensions

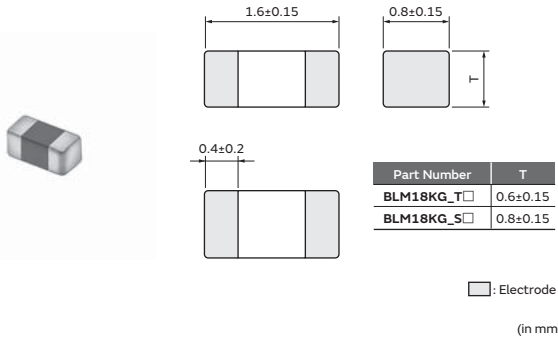

Packaging

Code	Packaging	Minimum Quantity
D	ø180mm Paper Tape	4000
J	ø330mm Paper Tape	10000
B	Bulk(Bag)	1000

Equivalent Circuit



(Resistance element becomes dominant at high frequencies.)

Rated Value (□: packaging code)

Part Number	Impedance at 100MHz	Rated Current at 85°C	Rated Current at 125°C	DC Resistance
BLM18KG221SN1□	220Ω±25%	2.2A	1.5A	0.05Ω
BLM18KG331SN1□	330Ω±25%	1.7A	1.2A	0.08Ω
BLM18KG471SN1□	470Ω±25%	1.5A	1A	0.13Ω
BLM18KG601SN1□	600Ω±25%	1.3A	1A	0.15Ω
BLM18KG102SN1□	1000Ω±25%	1A	800mA	0.2Ω
BLM18KG260TN1□	26Ω±25%	6A	4A	0.007Ω
BLM18KG300TN1□	30Ω±25%	5A	3.3A	0.01Ω
BLM18KG700TN1□	70Ω±25%	3.5A	2.2A	0.022Ω
BLM18KG101TN1□	100Ω±25%	3A	1.9A	0.03Ω
BLM18KG121TN1□	120Ω±25%	3A	1.9A	0.03Ω

Operating Temp. Range: -55°C to 125°C

Z-f characteristics

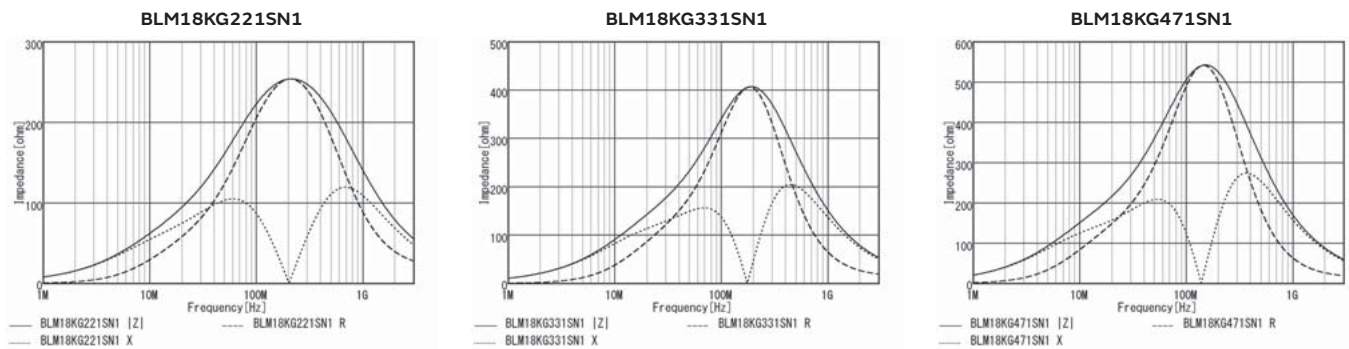

Continued on the following page. ↗

Continued from the preceding page. ↘

Z-f characteristics

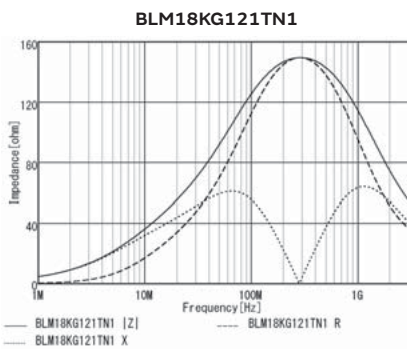
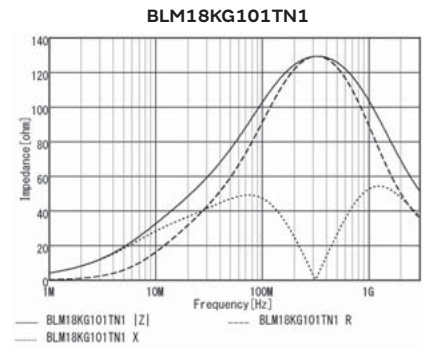
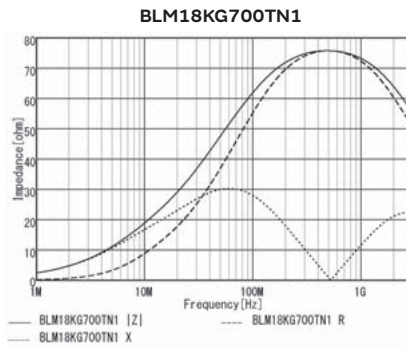
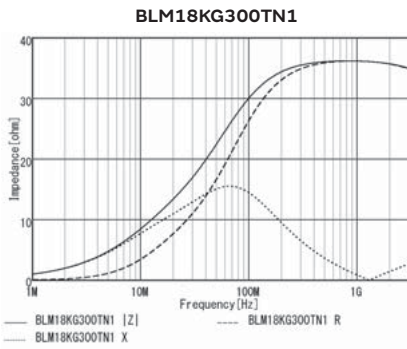
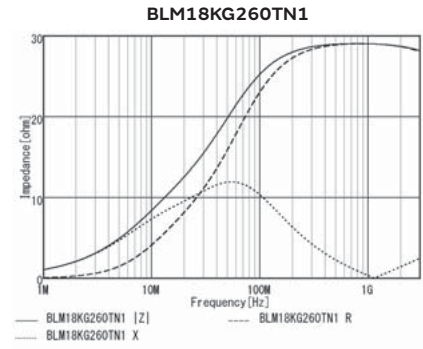
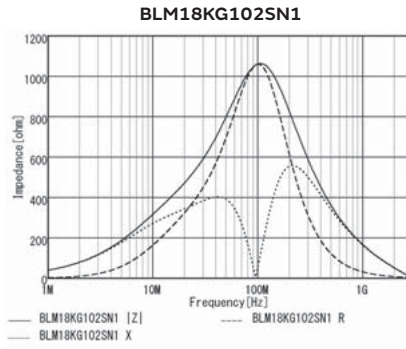
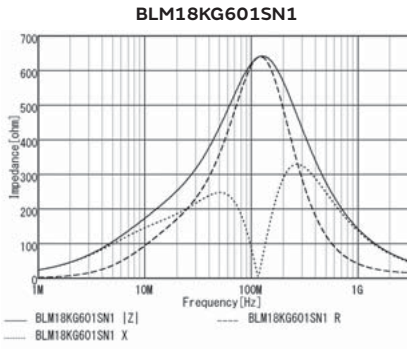

Derating of Rated Current

In operating temperature exceeding +85°C, derating of current is necessary for BLM18KG series.
 Please apply the derating curve shown in chart according to the operating temperature.

Derating of Rated Current

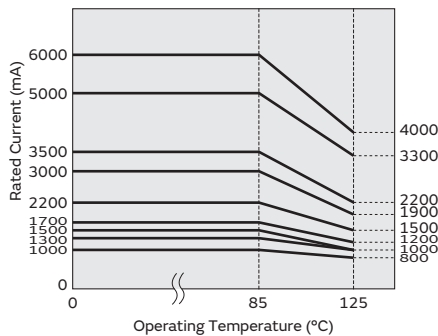

Chip ferrite bead

BLM18SD/SG/SN Series 0603/1608(inch/mm)

Appearance/Dimensions

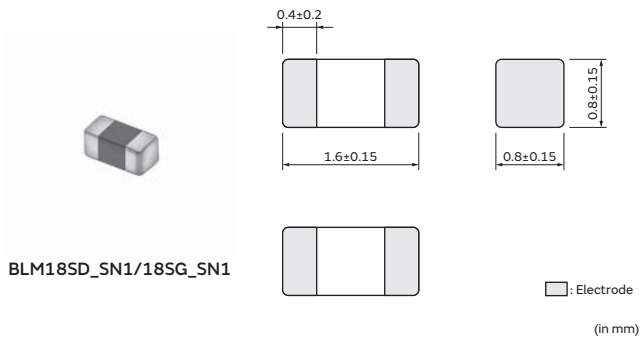

Packaging

Code	Packaging	Minimum Quantity
D	ø180mm Paper Tape	4000
J	ø330mm Paper Tape	10000
B	Bulk(Bag)	1000

Equivalent Circuit

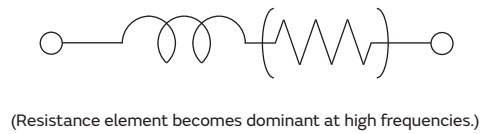

Appearance/Dimensions

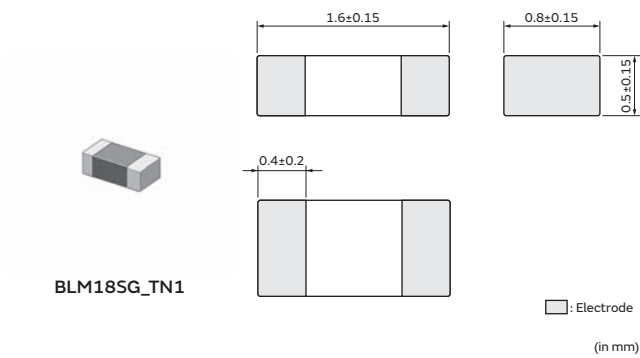

Packaging

Code	Packaging	Minimum Quantity
D	ø180mm Paper Tape	10000
J	ø330mm Paper Tape	30000
B	Bulk(Bag)	1000

Equivalent Circuit

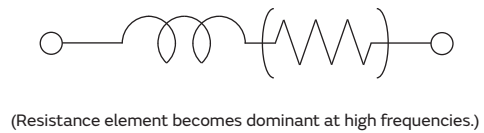

Appearance/Dimensions

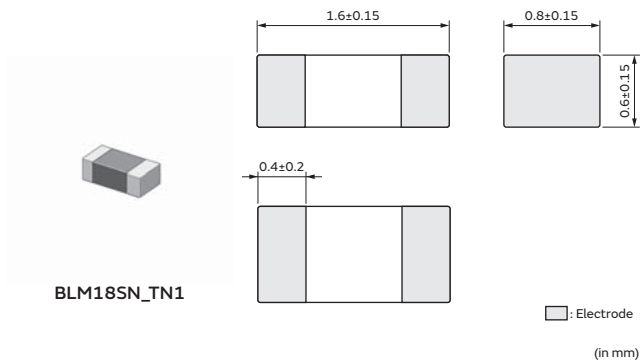

Packaging

Code	Packaging	Minimum Quantity
D	ø180mm Paper Tape	4000
B	Bulk(Bag)	1000

Equivalent Circuit

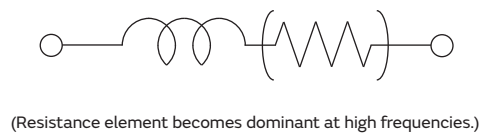

Rated Value (□: packaging code)

Part Number	Impedance at 100MHz	Rated Current at 85°C	Rated Current at 125°C	DC Resistance
BLM18SD220SN1□	22Ω±25%	6A	3.5A	0.008Ω
BLM18SG330SN1□	33Ω±25%	6A	3.5A	0.008Ω
BLM18SG260TN1□	26Ω±25%	6A	1A	0.007Ω
BLM18SG700TN1□	70Ω±25%	4A	1A	0.02Ω
BLM18SG121TN1□	120Ω±25%	3A	1A	0.025Ω

Operating Temp. Range: -55°C to 125°C

Continued from the preceding page. ↘

Part Number	Impedance at 100MHz	Rated Current at 85°C	Rated Current at 125°C	DC Resistance
BLM18SG221TN1□	220Ω±25%	2.5A	1A	0.04Ω
BLM18SG331TN1□	330Ω±25%	1.5A	1A	0.07Ω
BLM18SN220TN1□	22Ω±7%	8A	5A	0.004Ω

Operating Temp. Range: -55°C to 125°C

Z-f characteristics

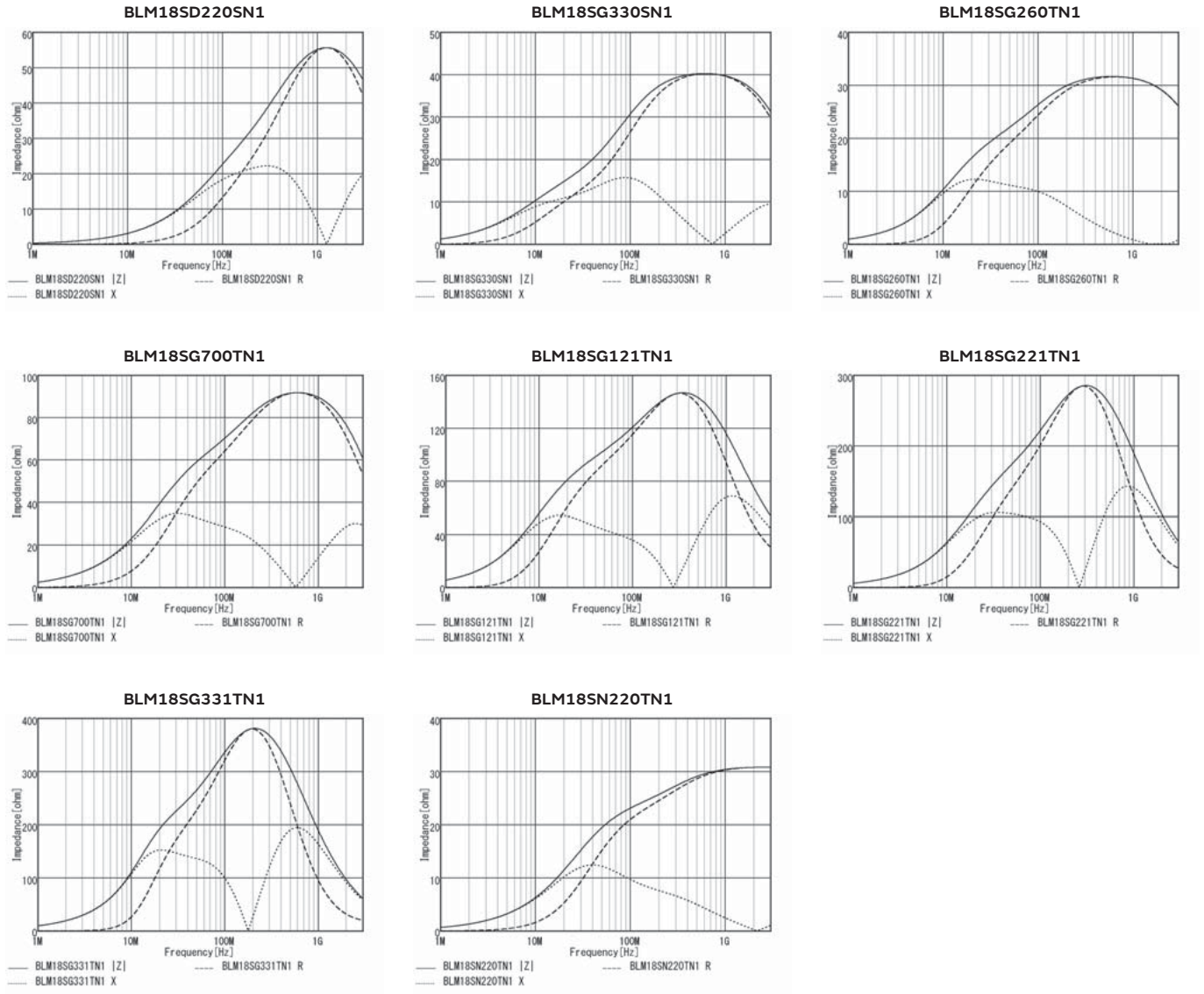

Continued on the following page. ↗

Chip Ferrite Bead

Application Specified Noise Filter

Chip EMIFIL®

Common Mode Choke Coil
 Common Mode Noise Filter

Block Type EMIFIL®

EMC Absorber

Continued from the preceding page. ↘

Derating of Rated Current

In operating temperature exceeding +85°C, derating of current is necessary for BLM18SD series. Please apply the derating curve shown in chart according to the operating temperature.

Derating of Rated Current

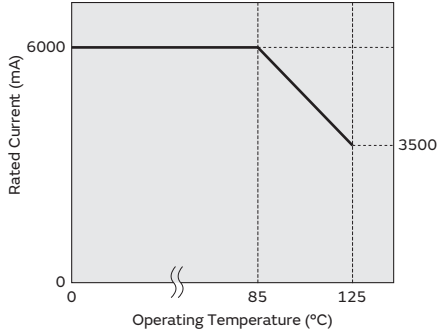

In operating temperature exceeding +85°C, derating of current is necessary for BLM18SG_S□1 series. Please apply the derating curve shown in chart according to the operating temperature.

Derating of Rated Current

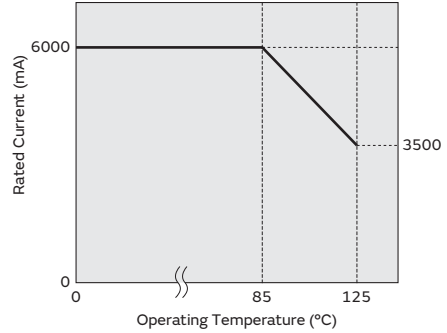

In operating temperature exceeding +85°C, derating of current is necessary for BLM18SG_T□1 series. Please apply the derating curve shown in chart according to the operating temperature.

Derating of Rated Current

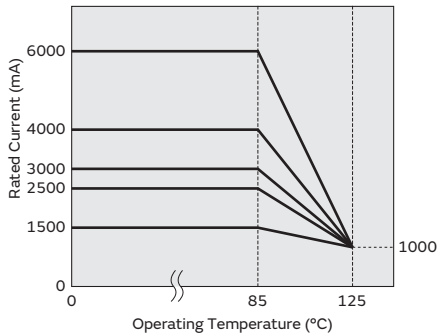

In operating temperature exceeding +85°C, derating of current is necessary for BLM18SN series. Please apply the derating curve shown in chart according to the operating temperature.

Derating of Rated Current

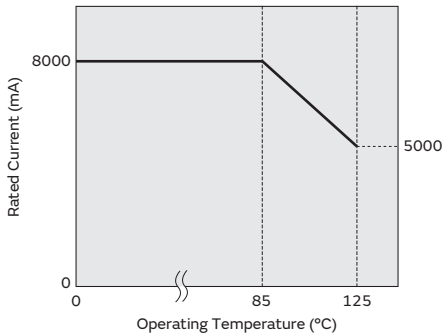

Chip ferrite bead

BLM18AG Series 0603/1608(inch/mm)

Appearance/Dimensions

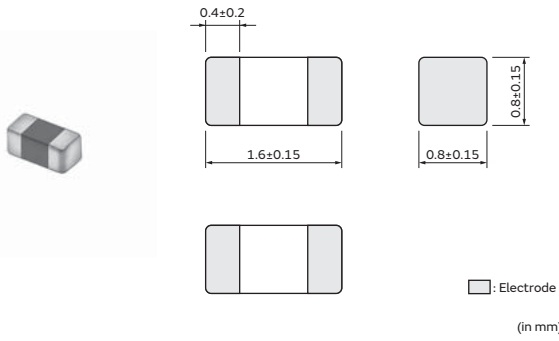

Packaging

Code	Packaging	Minimum Quantity
D	ø180mm Paper Tape	4000
J	ø330mm Paper Tape	10000
B	Bulk(Bag)	1000

Equivalent Circuit



(Resistance element becomes dominant at high frequencies.)

Rated Value (□: packaging code)

Part Number	Impedance at 100MHz	Rated Current at 85°C	Rated Current at 125°C	DC Resistance
BLM18AG121SN1□	120Ω±25%	800mA	800mA	0.18Ω
BLM18AG151SN1□	150Ω±25%	700mA	700mA	0.25Ω
BLM18AG221SN1□	220Ω±25%	700mA	700mA	0.25Ω
BLM18AG331SN1□	330Ω±25%	600mA	600mA	0.3Ω
BLM18AG471SN1□	470Ω±25%	550mA	550mA	0.35Ω
BLM18AG601SN1□	600Ω±25%	500mA	500mA	0.38Ω
BLM18AG102SN1□	1000Ω±25%	450mA	450mA	0.5Ω

Operating Temp. Range: -55°C to 125°C

Z-f characteristics

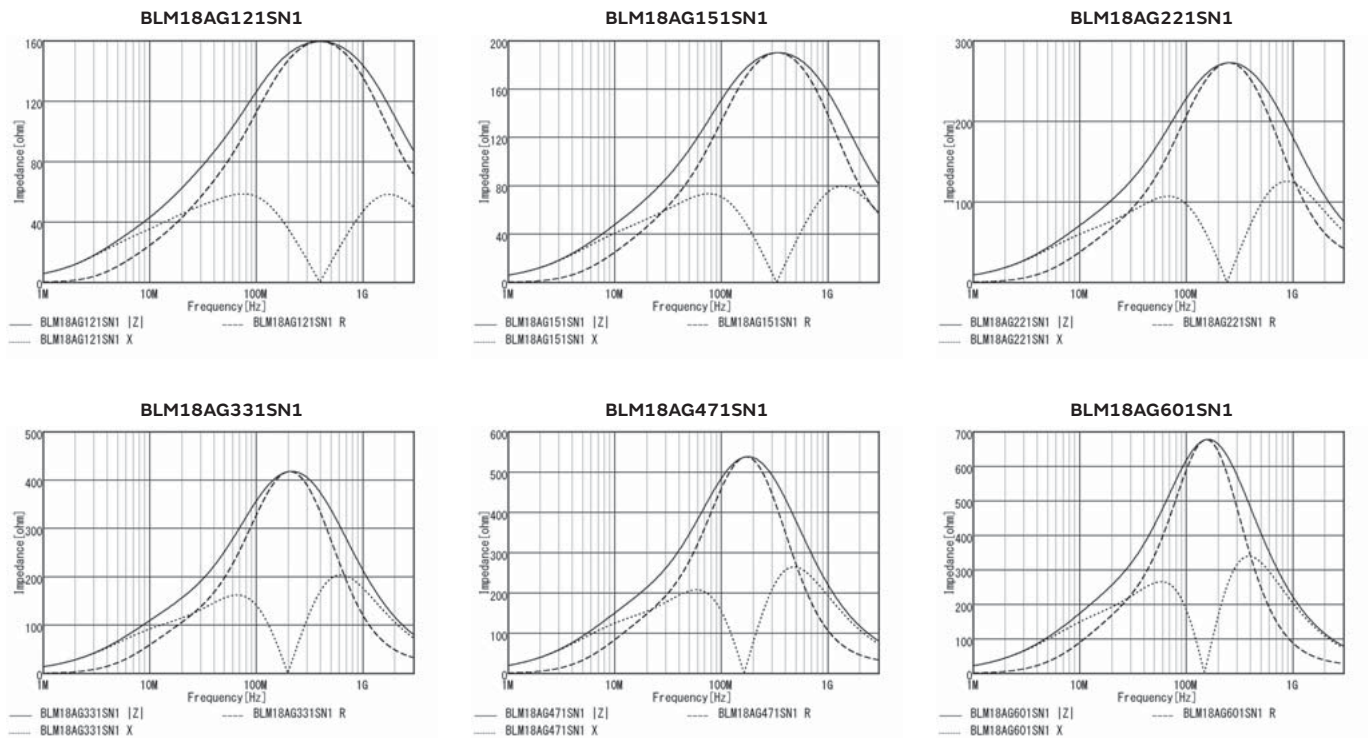

Continued on the following page. ↗

Continued from the preceding page. ↘

Z-f characteristics

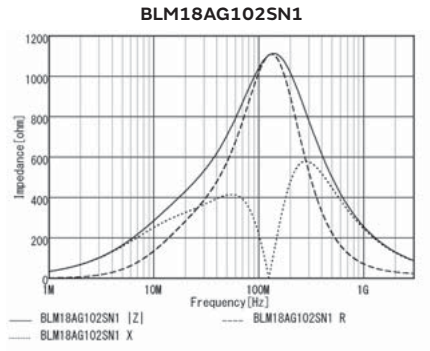

Chip ferrite bead

BLM18TG Series 0603/1608(inch/mm)

Appearance/Dimensions

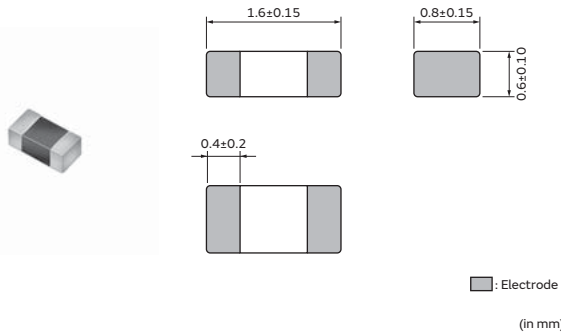

Packaging

Code	Packaging	Minimum Quantity
D	ø180mm Paper Tape	10000
B	Bulk(Bag)	1000

Equivalent Circuit



(Resistance element becomes dominant at high frequencies.)

Rated Value (□: packaging code)

Part Number	Impedance at 100MHz	Rated Current at 85°C	Rated Current at 125°C	DC Resistance
BLM18TG121TN1□	120Ω±25%	200mA	200mA	0.25Ω
BLM18TG221TN1□	220Ω±25%	200mA	200mA	0.3Ω
BLM18TG601TN1□	600Ω±25%	200mA	200mA	0.45Ω
BLM18TG102TN1□	1000Ω±25%	100mA	100mA	0.6Ω

Operating Temp. Range: -55°C to 125°C

Z-f characteristics

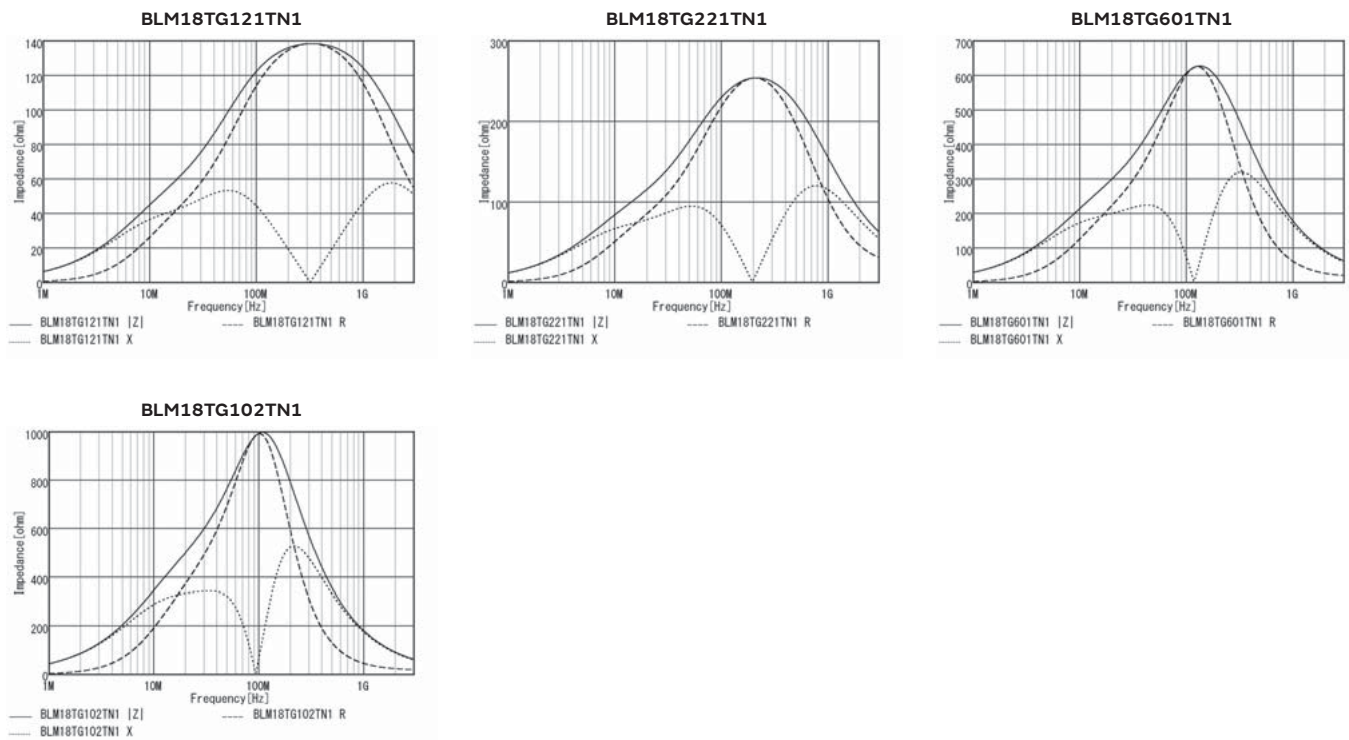

Chip ferrite bead

BLM18BA/BB/BD Series 0603/1608(inch/mm)

Appearance/Dimensions

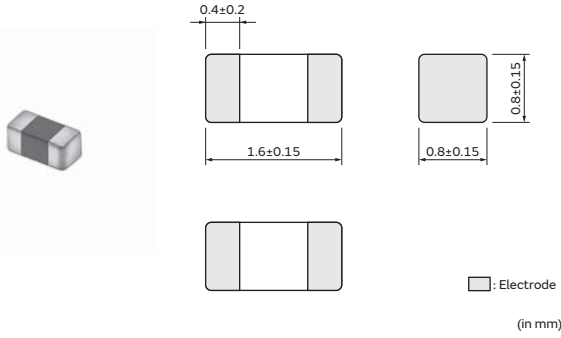

Packaging

Code	Packaging	Minimum Quantity
D	ø180mm Paper Tape	4000
J	ø330mm Paper Tape	10000
B	Bulk(Bag)	1000

Equivalent Circuit



(Resistance element becomes dominant at high frequencies.)

Rated Value (□: packaging code)

Part Number	Impedance at 100MHz	Rated Current at 85°C	Rated Current at 125°C	DC Resistance
BLM18BA050SN1□	5Ω±25%	500mA	500mA	0.2Ω
BLM18BA100SN1□	10Ω±25%	500mA	500mA	0.25Ω
BLM18BA220SN1□	22Ω±25%	500mA	500mA	0.35Ω
BLM18BA470SN1□	47Ω±25%	300mA	300mA	0.55Ω
BLM18BA750SN1□	75Ω±25%	300mA	300mA	0.7Ω
BLM18BA121SN1□	120Ω±25%	200mA	200mA	0.9Ω
BLM18BB050SN1□	5Ω±25%	800mA	800mA	0.05Ω
BLM18BB100SN1□	10Ω±25%	700mA	700mA	0.1Ω
BLM18BB220SN1□	22Ω±25%	700mA	700mA	0.2Ω
BLM18BB470SN1□	47Ω±25%	600mA	600mA	0.25Ω
BLM18BB600SN1□	60Ω±25%	600mA	600mA	0.25Ω
BLM18BB750SN1□	75Ω±25%	600mA	600mA	0.3Ω
BLM18BB121SN1□	120Ω±25%	550mA	550mA	0.3Ω
BLM18BB141SN1□	140Ω±25%	500mA	500mA	0.35Ω
BLM18BB151SN1□	150Ω±25%	450mA	450mA	0.37Ω
BLM18BB221SN1□	220Ω±25%	450mA	450mA	0.45Ω
BLM18BB331SN1□	330Ω±25%	400mA	400mA	0.58Ω
BLM18BB471SN1□	470Ω±25%	300mA	300mA	0.85Ω
BLM18BD470SN1□	47Ω±25%	500mA	500mA	0.3Ω
BLM18BD121SN1□	120Ω±25%	300mA	300mA	0.4Ω
BLM18BD151SN1□	150Ω±25%	300mA	300mA	0.4Ω
BLM18BD221SN1□	220Ω±25%	250mA	250mA	0.45Ω
BLM18BD331SN1□	330Ω±25%	250mA	250mA	0.5Ω
BLM18BD421SN1□	420Ω±25%	250mA	250mA	0.55Ω
BLM18BD471SN1□	470Ω±25%	250mA	250mA	0.55Ω
BLM18BD601SN1□	600Ω±25%	200mA	200mA	0.65Ω
BLM18BD102SN1□	1000Ω±25%	200mA	200mA	0.85Ω
BLM18BD152SN1□	1500Ω±25%	150mA	150mA	1.2Ω
BLM18BD182SN1□	1800Ω±25%	150mA	150mA	1.5Ω
BLM18BD222SN1□	2200Ω±25%	150mA	150mA	1.5Ω
BLM18BD252SN1□	2500Ω±25%	150mA	150mA	1.5Ω

Operating Temp. Range: -55°C to 125°C

Continued on the following page. ↗

Continued from the preceding page. ↘

Z-f characteristics

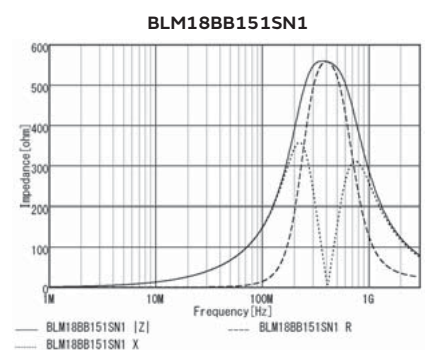
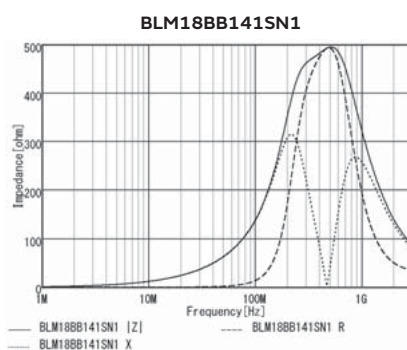
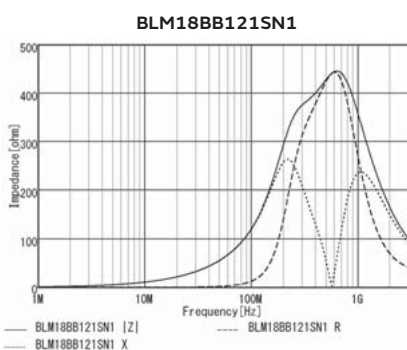
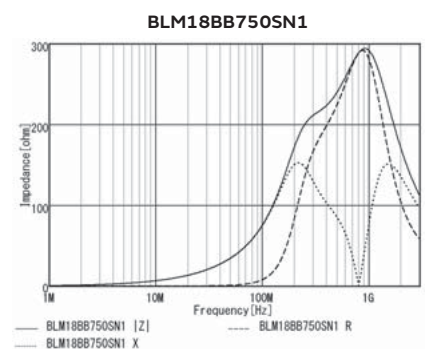
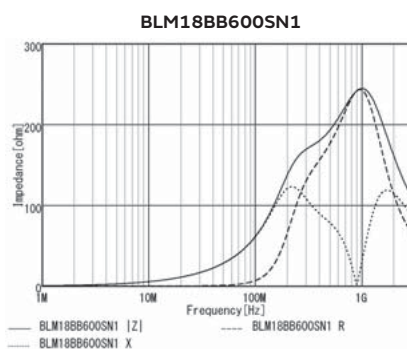
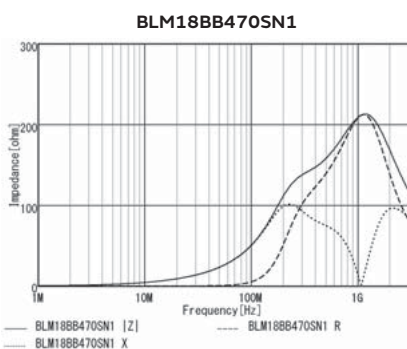
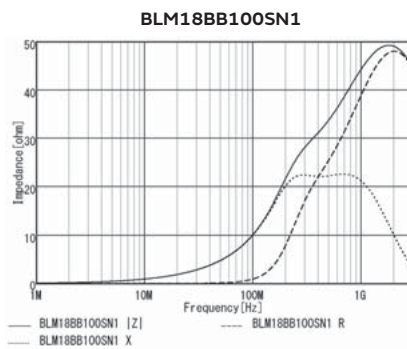
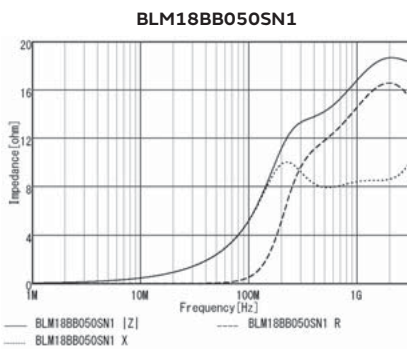
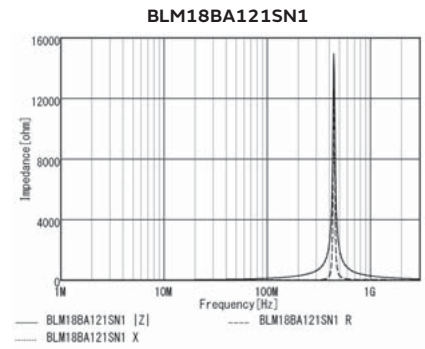
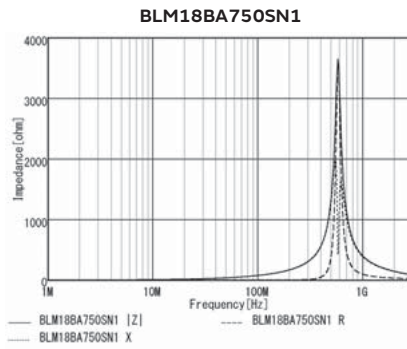
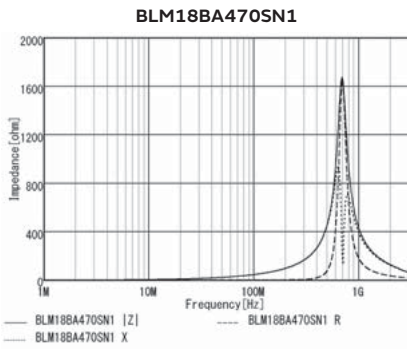
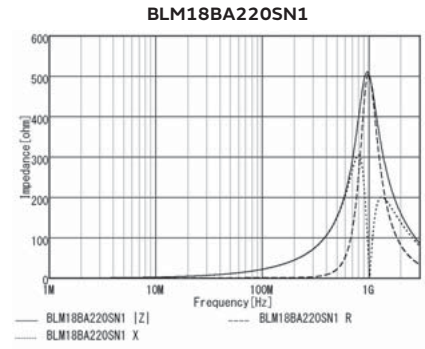
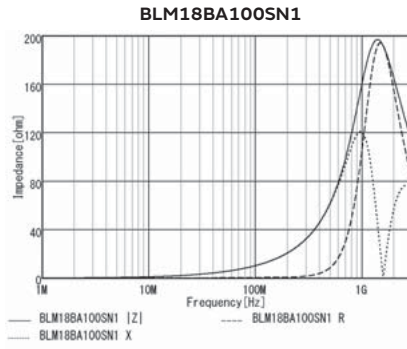
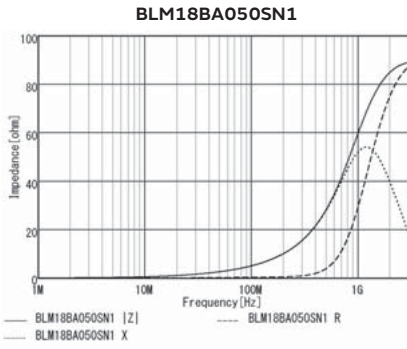

Chip Ferrite Bead

Application Specified Noise Filter

Chip EMIFIL®

Common Mode Choke Coil
 Common Mode Noise Filter

Block Type EMIFIL®

EMC Absorber

Continued from the preceding page. ↘

Z-f characteristics

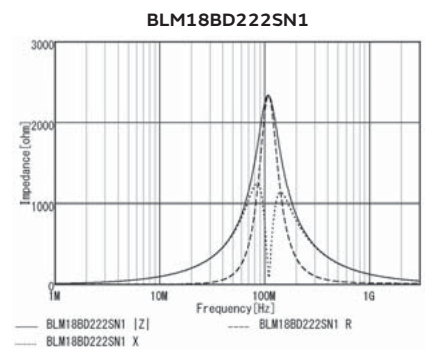
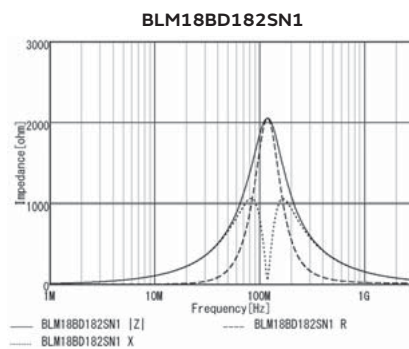
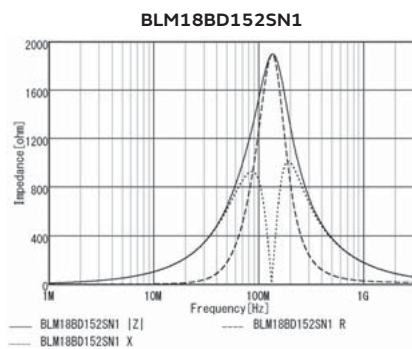
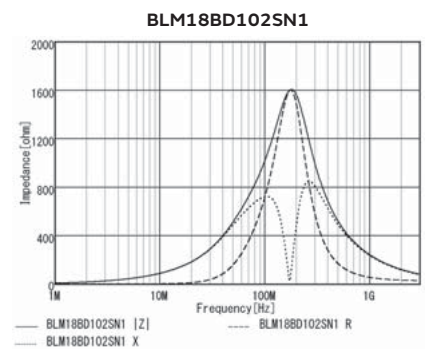
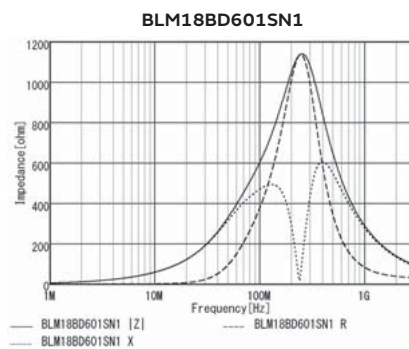
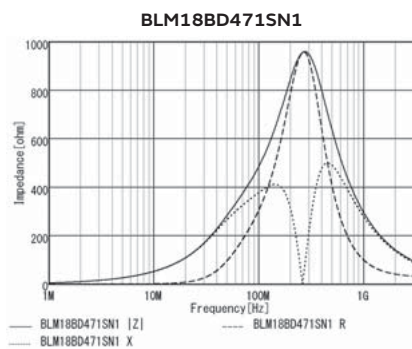
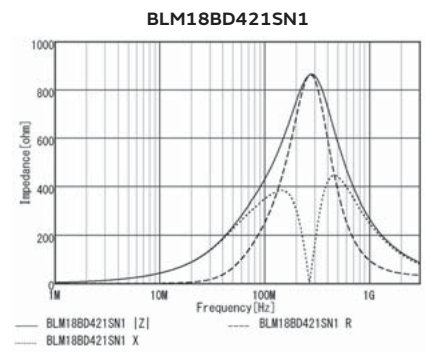
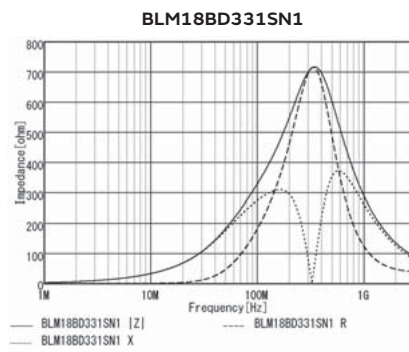
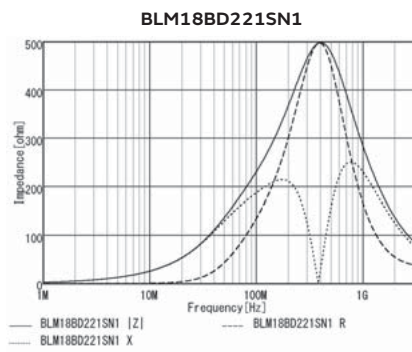
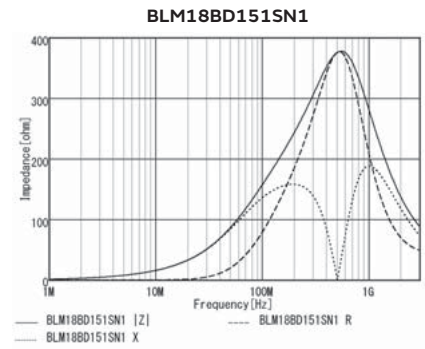
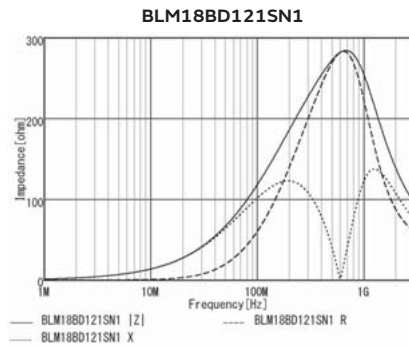
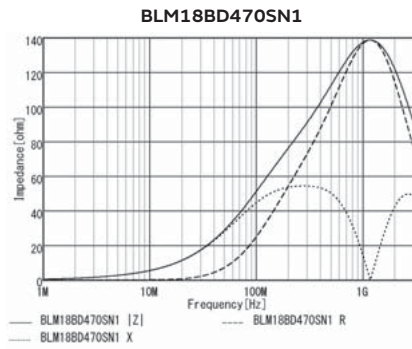
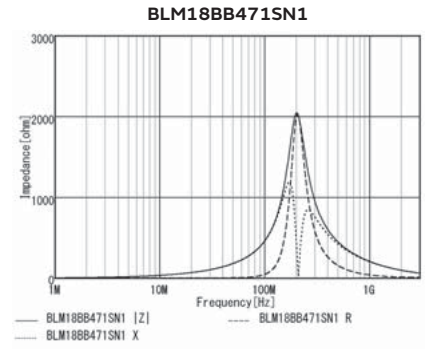
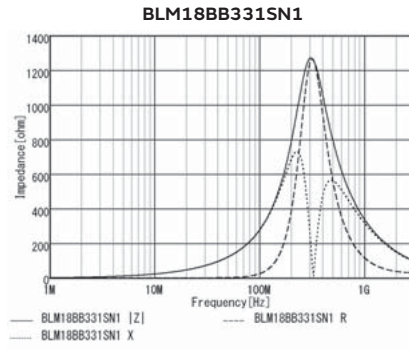
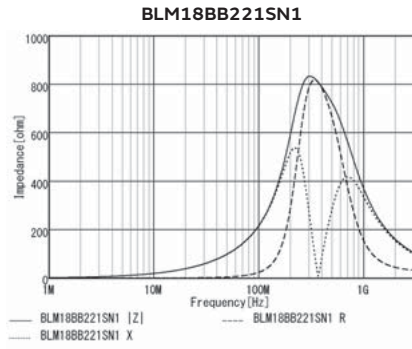

Continued from the preceding page. ↘

Z-f characteristics

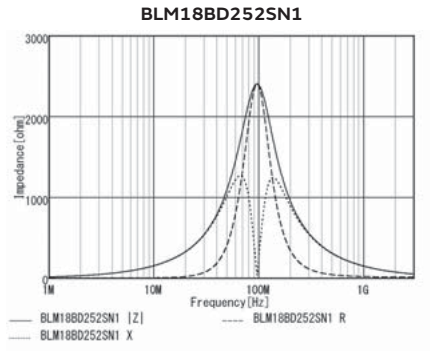

Chip Ferrite Bead

Application Specified Noise Filter

Chip EMIFIL®

Common Mode Choke Coil
Common Mode Noise Filter

Block Type EMIFIL®

EMC Absorber

Chip ferrite bead

BLM18RK Series 0603/1608(inch/mm)

Appearance/Dimensions

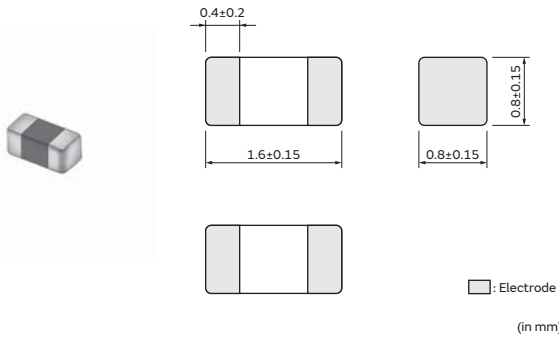

Packaging

Code	Packaging	Minimum Quantity
D	ø180mm Paper Tape	4000
J	ø330mm Paper Tape	10000
B	Bulk(Bag)	1000

Equivalent Circuit



(Resistance element becomes dominant at high frequencies.)

Rated Value (□: packaging code)

Part Number	Impedance at 100MHz	Rated Current at 85°C	Rated Current at 125°C	DC Resistance
BLM18RK121SN1□	120Ω±25%	200mA	200mA	0.25Ω
BLM18RK221SN1□	220Ω±25%	200mA	200mA	0.3Ω
BLM18RK471SN1□	470Ω±25%	200mA	200mA	0.5Ω
BLM18RK601SN1□	600Ω±25%	200mA	200mA	0.6Ω
BLM18RK102SN1□	1000Ω±25%	200mA	200mA	0.8Ω

Operating Temp. Range: -55°C to 125°C

Z-f characteristics

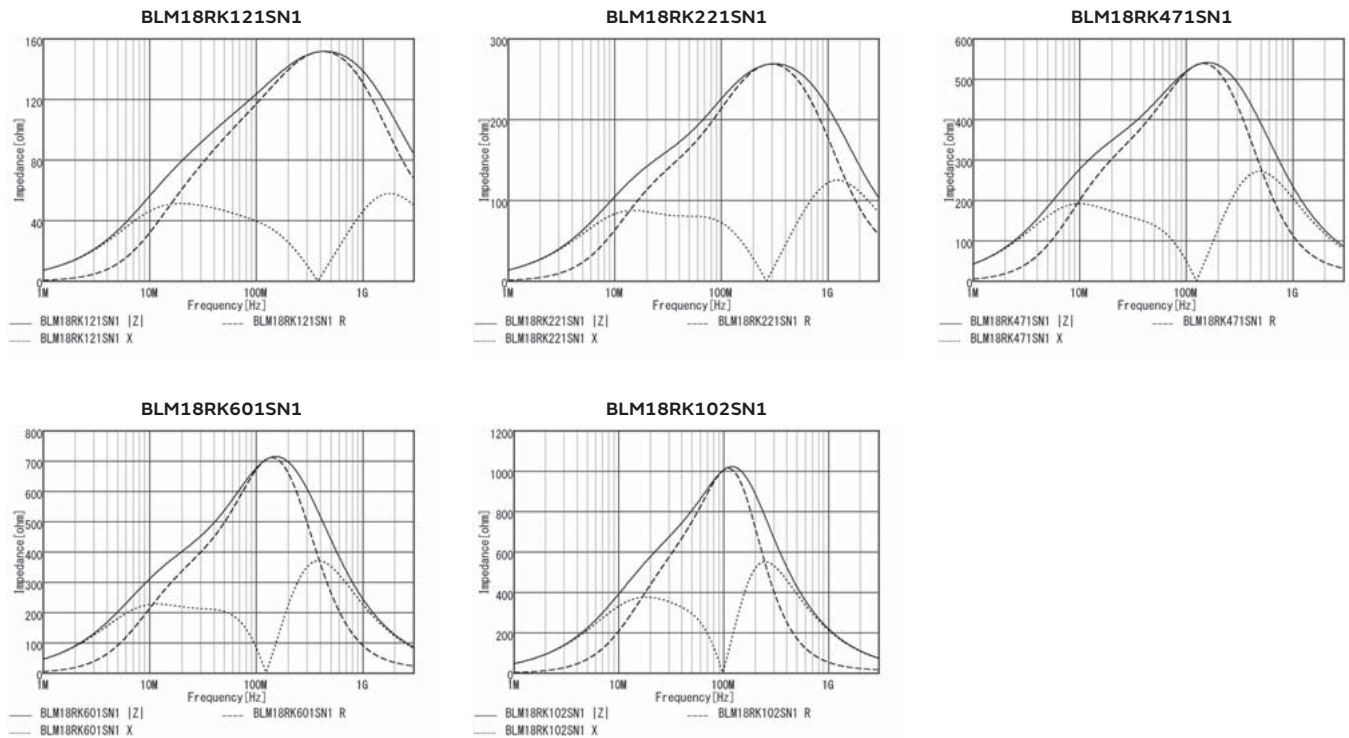

Chip Ferrite Bead (BLM□□R Series) EMI Suppression Effect

Waveform Distortion Suppressing Performance of BLM□□R Series

Measuring Circuits

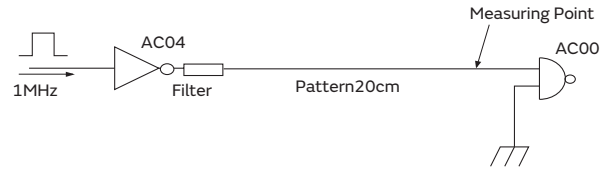

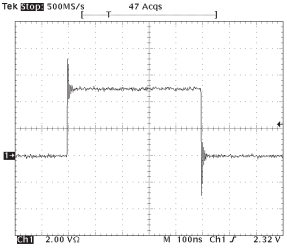
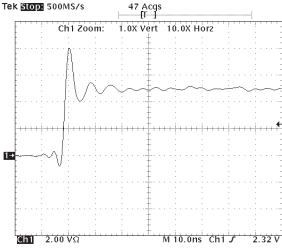
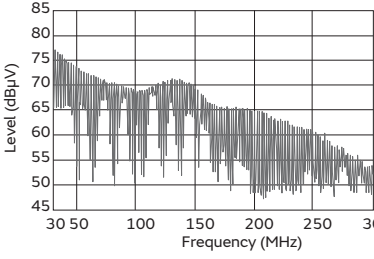
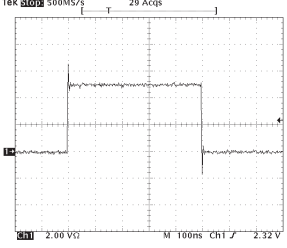
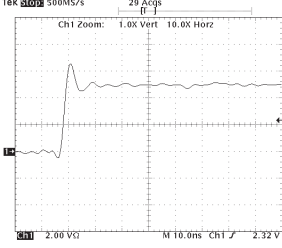
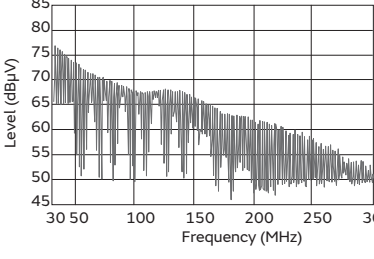
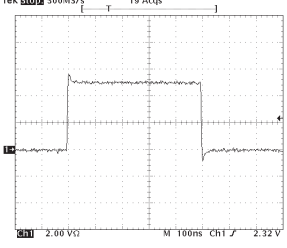
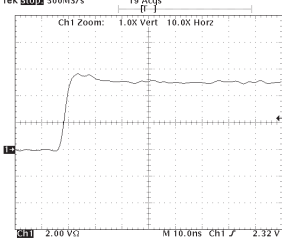
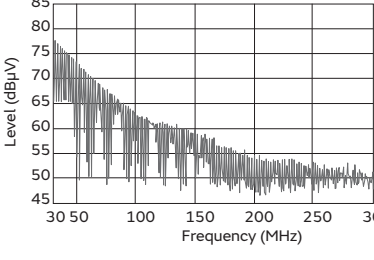
Type of Filter	EMI Suppression Effect / Description		
<p>Initial (No filter)</p>	<p>Signal waveform (100nsec/div, 2V/div)</p> 	<p>Expand (10nsec/div, 2V/div)</p> 	<p>Spectrum</p> 
<p>Resistor (47Ω) is used</p>	<p>Signal waveform (100nsec/div, 2V/div)</p> 	<p>Expand (10nsec/div, 2V/div)</p> 	<p>Spectrum</p> 
<p>BLM18RK221SN1 (220Ω at 100MHz) is used</p>	<p>Signal waveform (100nsec/div, 2V/div)</p> 	<p>Expand (10nsec/div, 2V/div)</p> 	<p>Spectrum</p> 

Ringing is caused on the signal waveform. Such ringing contains several hundred MHz harmonic components and generates noise.

Comparing initial waveform, ringing is suppressed a little. However, high level waveform distortion still remains.

BLM18R has excellent performance for noise suppression and waveform distortion suppression. BLM18R suppresses drastically not only the spectrum level in more than 100MHz range but waveform distortion.

Chip Ferrite Bead
Application Specified Noise Filter
Chip EMIFIL®
Common Mode Choke Coil
Common Mode Noise Filter
Block Type EMIFIL®
EMC Absorber

Chip ferrite bead

BLM21PG Series 0805/2012(inch/mm)

Appearance/Dimensions

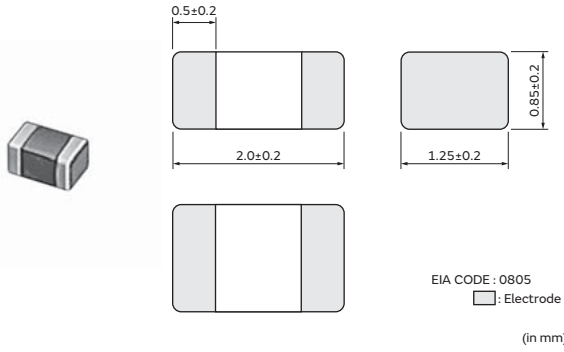

Packaging

Code	Packaging	Minimum Quantity
D	ø180mm Paper Tape	4000
J	ø330mm Paper Tape	10000
B	Bulk(Bag)	1000

Equivalent Circuit



(Resistance element becomes dominant at high frequencies.)

Rated Value (□: packaging code)

Part Number	Impedance at 100MHz	Rated Current at 85°C	Rated Current at 125°C	DC Resistance
BLM21PG220SN1□	22Ω±25%	6A	3.3A	0.009Ω
BLM21PG300SN1□	30Ω(Typ.)	4A	2.3A	0.014Ω
BLM21PG600SN1□	60Ω±25%	3.5A	1.9A	0.02Ω
BLM21PG121SN1□	120Ω±25%	3A	1.55A	0.03Ω
BLM21PG221SN1□	220Ω±25%	2A	1.25A	0.045Ω
BLM21PG331SN1□	330Ω±25%	1.5A	1A	0.07Ω

Operating Temp. Range: -55°C to 125°C

Z-f characteristics

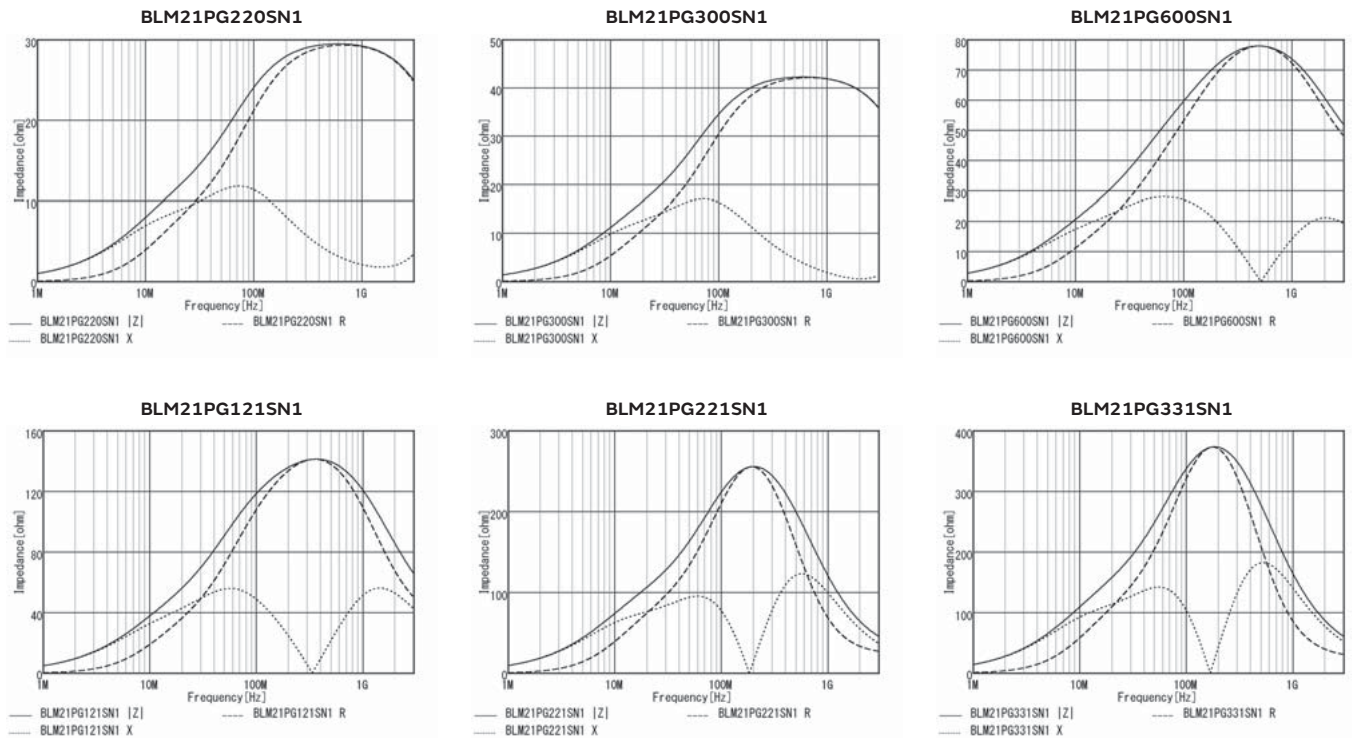

Continued on the following page. ↗

Continued from the preceding page. ↘

Derating of Rated Current

In operating temperature exceeding +85°C, derating of current is necessary for BLM21PG series.
 Please apply the derating curve shown in chart according to the operating temperature.

Derating of Rated Current

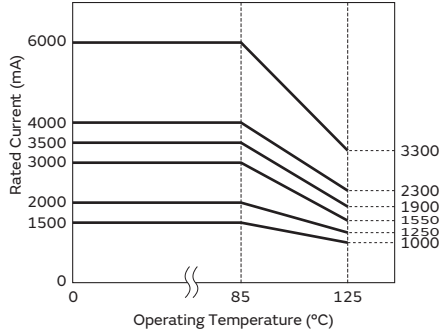

Chip Ferrite Bead

Application Specified Noise Filter

Chip EMIFIL®

Common Mode Choke Coil
 Common Mode Noise Filter

Block Type EMIFIL®

EMC Absorber

Chip ferrite bead

BLM21SN/SP Series 0805/2012(inch/mm)

Appearance/Dimensions

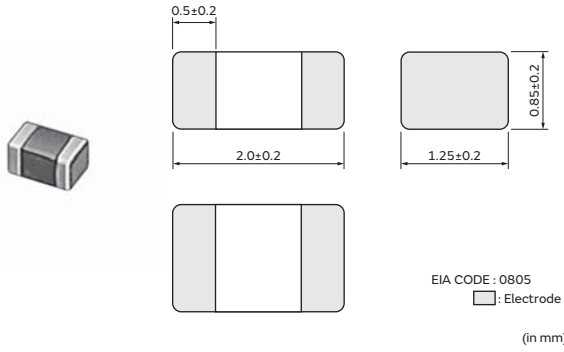

Packaging

Code	Packaging	Minimum Quantity
D	ø180mm Paper Tape	4000
J	ø330mm Paper Tape	10000
B	Bulk(Bag)	1000

Equivalent Circuit



(Resistance element becomes dominant at high frequencies.)

Rated Value (□: packaging code)

Part Number	Impedance at 100MHz	Rated Current at 85°C	Rated Current at 125°C	DC Resistance
BLM21SN300SN1□	30Ω±10Ω	8.5A	6A	0.004Ω
BLM21SP700SN1□	70Ω±25%	6A	4A	0.009Ω
BLM21SP111SN1□	110Ω±25%	5A	3.3A	0.013Ω
BLM21SP181SN1□	180Ω±25%	4A	2.6A	0.02Ω
BLM21SP331SN1□	330Ω±25%	2.8A	1.9A	0.04Ω
BLM21SP471SN1□	470Ω±25%	2.5A	1.7A	0.05Ω
BLM21SP601SN1□	600Ω±25%	2.3A	1.5A	0.06Ω
BLM21SP102SN1□	1000Ω±25%	1.6A	1.1A	0.12Ω

Operating Temp. Range: -55°C to 125°C

Z-f characteristics

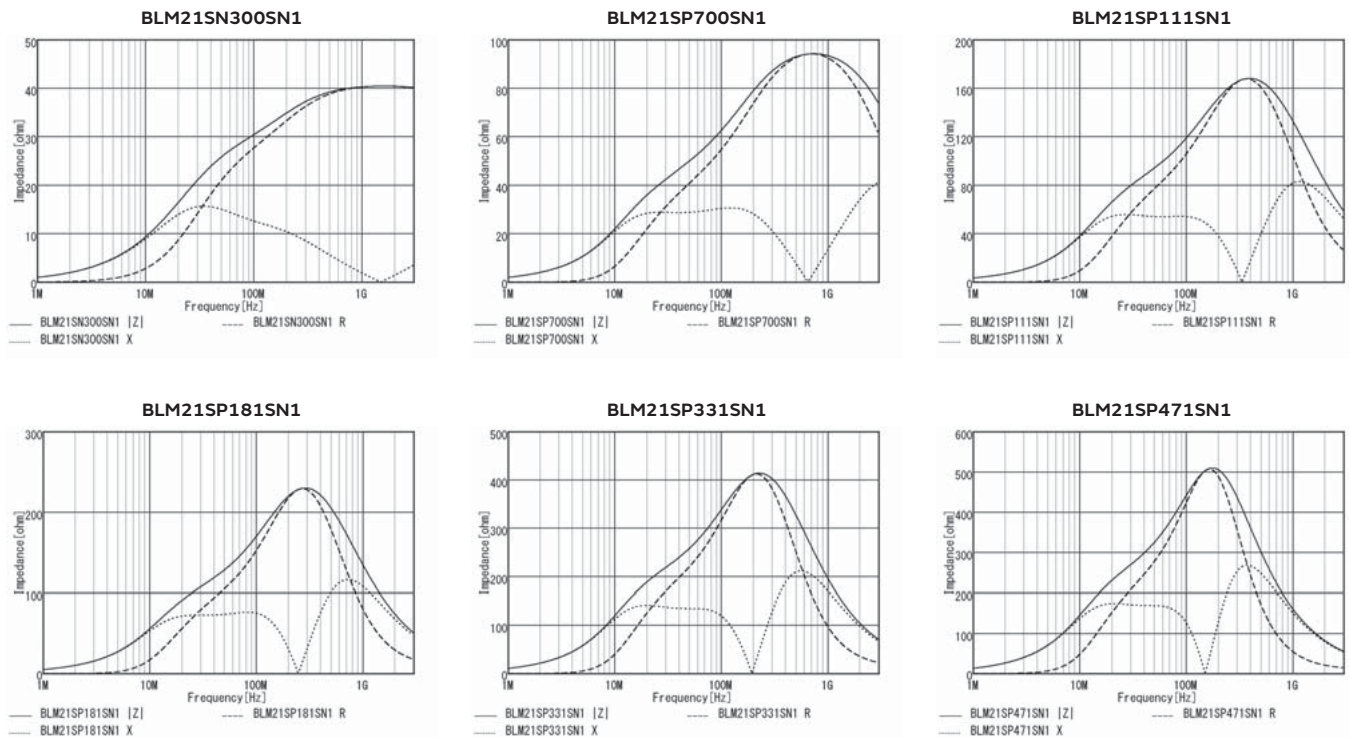

Continued on the following page. ↗

Continued from the preceding page. ↘

Z-f characteristics

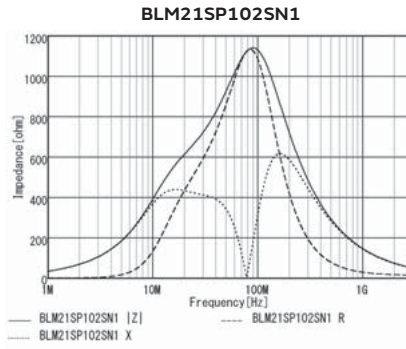
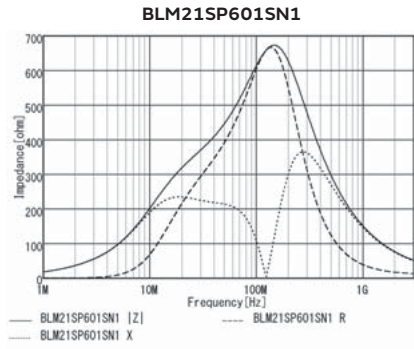

Derating of Rated Current

In operating temperature exceeding +85°C, derating of current is necessary for BLM21SN series. Please apply the derating curve shown in chart according to the operating temperature.

Derating of Rated Current

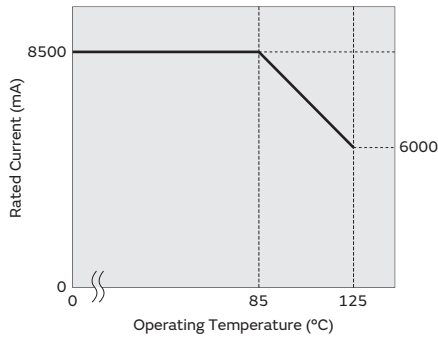

In operating temperature exceeding +85°C, derating of current is necessary for BLM21SP series. Please apply the derating curve shown in chart according to the operating temperature.

Derating of Rated Current

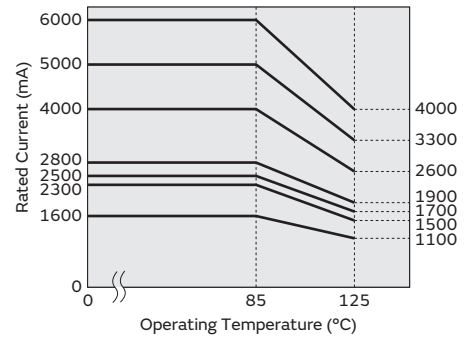

Chip Ferrite Bead

Application Specified Noise Filter

Chip EMIFIL®

Common Mode Choke Coil
 Common Mode Noise Filter

Block Type EMIFIL®

EMC Absorber

Chip ferrite bead

BLM21AG Series 0805/2012(inch/mm)

Appearance/Dimensions

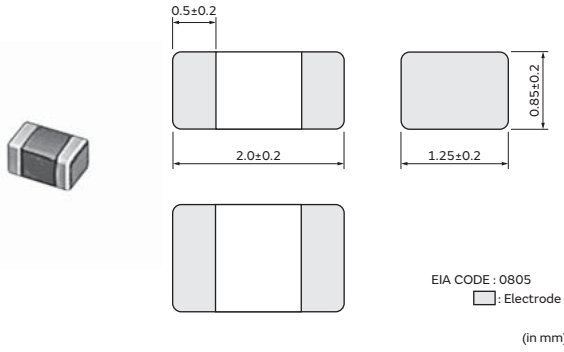

Packaging

Code	Packaging	Minimum Quantity
D	ø180mm Paper Tape	4000
J	ø330mm Paper Tape	10000
B	Bulk(Bag)	1000

Equivalent Circuit



(Resistance element becomes dominant at high frequencies.)

Rated Value (□: packaging code)

Part Number	Impedance at 100MHz	Rated Current at 85°C	Rated Current at 125°C	DC Resistance
BLM21AG121SN1□	120Ω±25%	1A	1A	0.09Ω
BLM21AG151SN1□	150Ω±25%	1A	1A	0.09Ω
BLM21AG221SN1□	220Ω±25%	900mA	900mA	0.12Ω
BLM21AG331SN1□	330Ω±25%	800mA	800mA	0.15Ω
BLM21AG471SN1□	470Ω±25%	700mA	700mA	0.18Ω
BLM21AG601SN1□	600Ω±25%	700mA	700mA	0.2Ω
BLM21AG102SN1□	1000Ω±25%	600mA	600mA	0.27Ω

Operating Temp. Range: -55°C to 125°C

Z-f characteristics

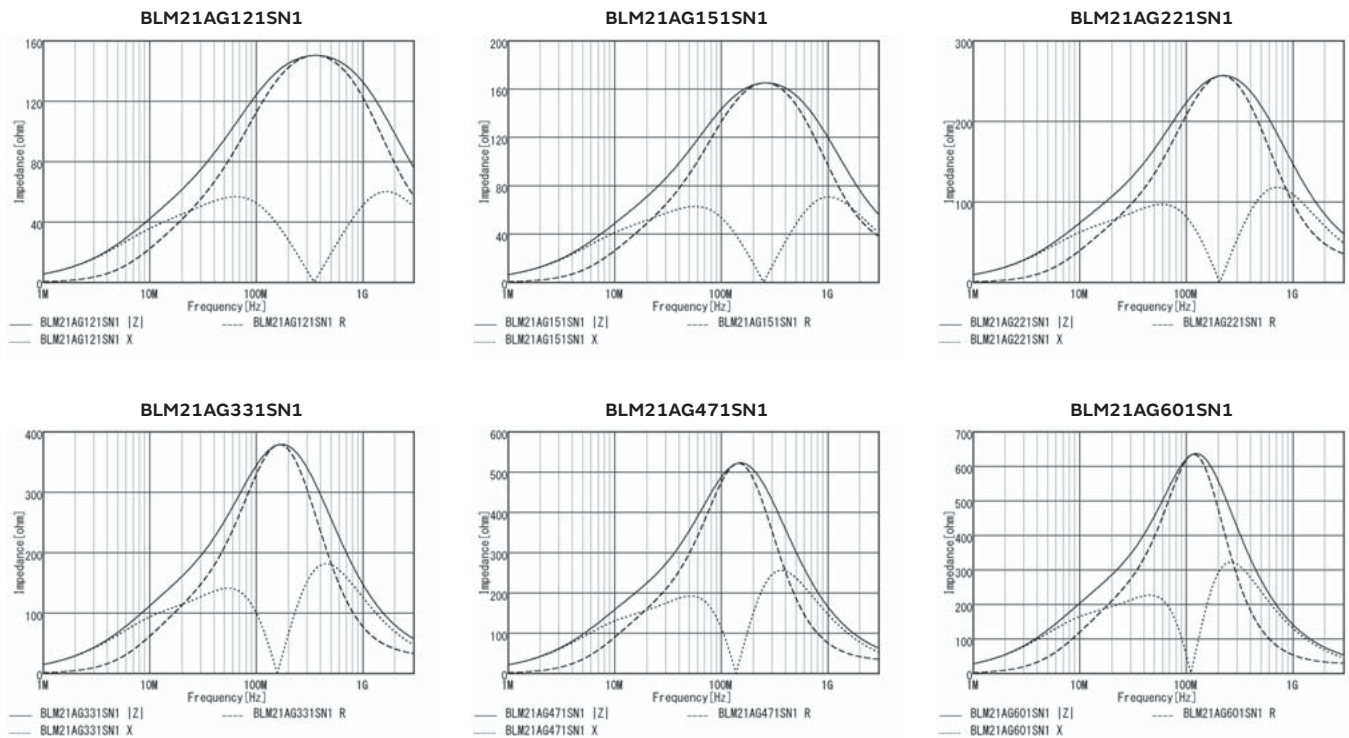

Continued on the following page. ↗

Continued from the preceding page. ↘

Z-f characteristics

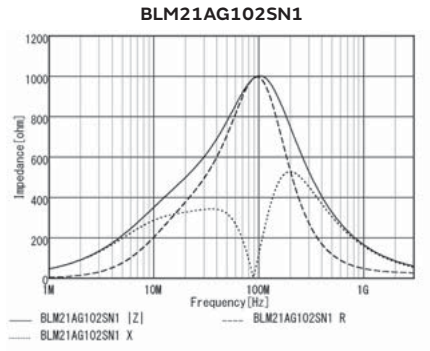

Chip Ferrite Bead

Application Specified Noise Filter

Chip EMIFIL®

Common Mode Choke Coil
Common Mode Noise Filter

Block Type EMIFIL®

EMC Absorber

Chip ferrite bead

BLM21BB/BD Series 0805/2012(inch/mm)

Appearance/Dimensions

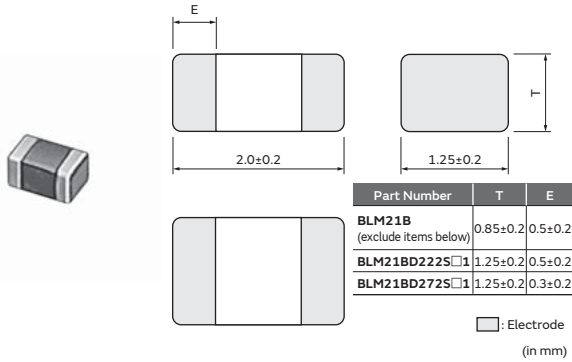

Packaging

All except for BLM21BD222SN1/BLM21BD272SN1

Code	Packaging	Minimum Quantity
D	ø180mm Paper Tape	4000
J	ø330mm Paper Tape	10000
B	Bulk(Bag)	1000

BLM21BD222SN1/BLM21BD272SN1 only

Code	Packaging	Minimum Quantity
K	ø330mm Embossed Tape	10000
L	ø180mm Embossed Tape	3000
B	Bulk(Bag)	1000

Equivalent Circuit



(Resistance element becomes dominant at high frequencies.)

Rated Value (□: packaging code)

Part Number	Impedance at 100MHz	Rated Current at 85°C	Rated Current at 125°C	DC Resistance
BLM21BB050SN1□	5Ω±25%	1A	1A	0.02Ω
BLM21BB600SN1□	60Ω±25%	800mA	800mA	0.13Ω
BLM21BB750SN1□	75Ω±25%	700mA	700mA	0.16Ω
BLM21BB121SN1□	120Ω±25%	600mA	600mA	0.19Ω
BLM21BB151SN1□	150Ω±25%	600mA	600mA	0.21Ω
BLM21BB201SN1□	200Ω±25%	500mA	500mA	0.26Ω
BLM21BB221SN1□	220Ω±25%	500mA	500mA	0.26Ω
BLM21BB331SN1□	330Ω±25%	400mA	400mA	0.33Ω
BLM21BB471SN1□	470Ω±25%	400mA	400mA	0.4Ω
BLM21BD121SN1□	120Ω±25%	350mA	350mA	0.25Ω
BLM21BD151SN1□	150Ω±25%	350mA	350mA	0.25Ω
BLM21BD221SN1□	220Ω±25%	350mA	350mA	0.25Ω
BLM21BD331SN1□	330Ω±25%	300mA	300mA	0.3Ω
BLM21BD421SN1□	420Ω±25%	300mA	300mA	0.3Ω
BLM21BD471SN1□	470Ω±25%	300mA	300mA	0.35Ω
BLM21BD601SN1□	600Ω±25%	300mA	300mA	0.35Ω
BLM21BD751SN1□	750Ω±25%	250mA	250mA	0.4Ω
BLM21BD102SN1□	1000Ω±25%	250mA	250mA	0.4Ω
BLM21BD152SN1□	1500Ω±25%	250mA	250mA	0.45Ω
BLM21BD182SN1□	1800Ω±25%	250mA	250mA	0.5Ω
BLM21BD222SN1□	2250Ω(Typ.)	250mA	250mA	0.6Ω
BLM21BD272SN1□	2700Ω±25%	200mA	200mA	0.8Ω
BLM21BD222TN1□	2200Ω±25%	200mA	200mA	0.6Ω

Operating Temp. Range: -55°C to 125°C

Continued on the following page. ↗

Continued from the preceding page. ↘

Z-f characteristics

BLM21BB050SN1

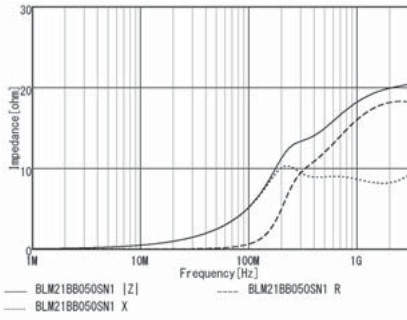

BLM21BB600SN1

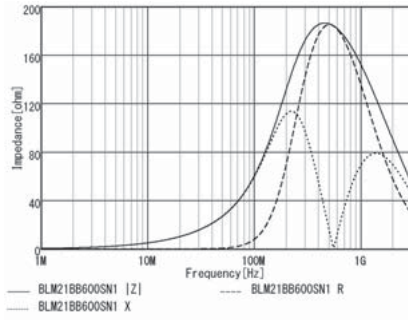

BLM21BB750SN1

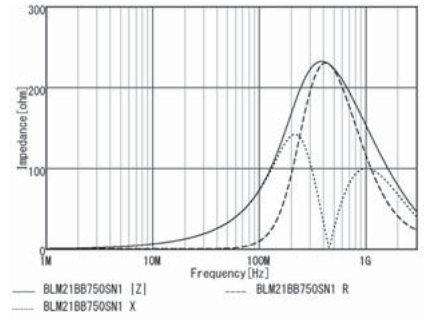

BLM21BB121SN1

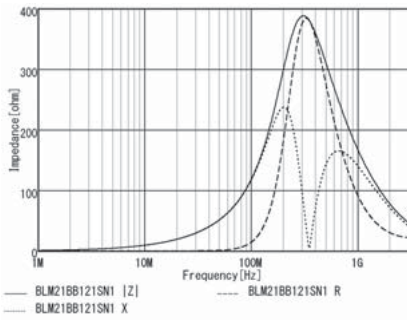

BLM21BB151SN1

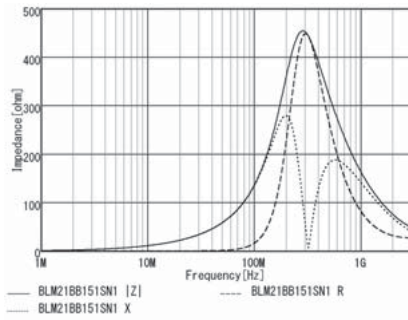

BLM21BB201SN1

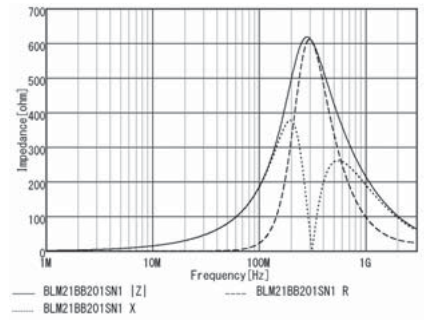

BLM21BB221SN1

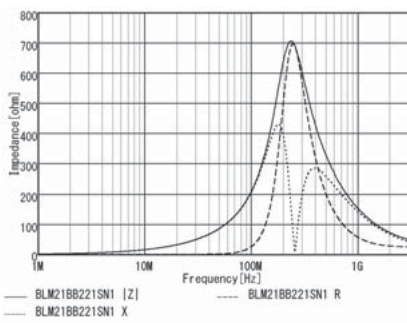

BLM21BB331SN1

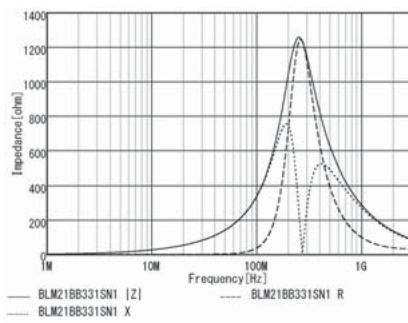

BLM21BB471SN1

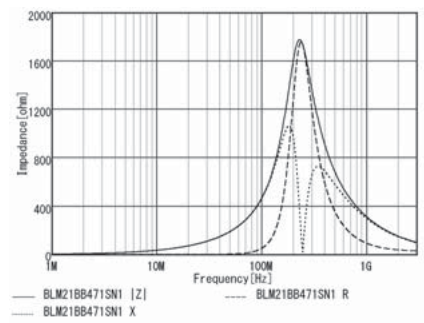

BLM21BD121SN1

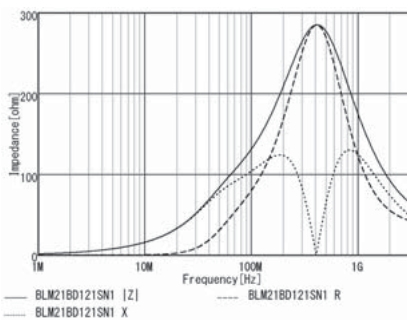

BLM21BD151SN1

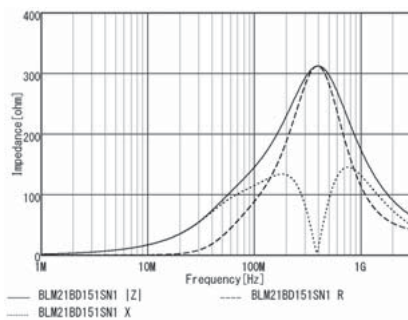

BLM21BD221SN1

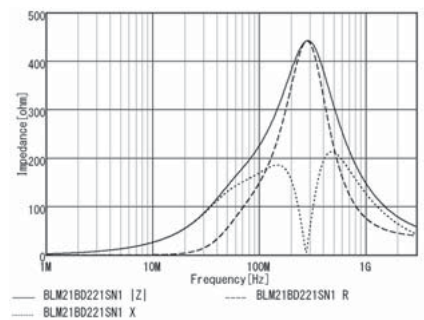

BLM21BD331SN1

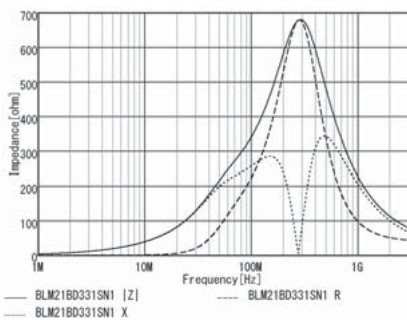

BLM21BD421SN1

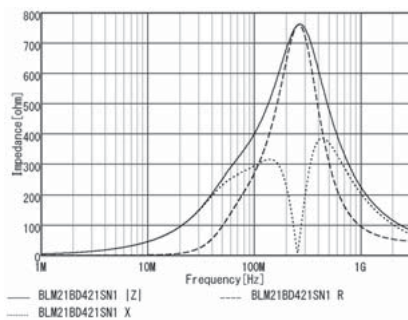

BLM21BD471SN1

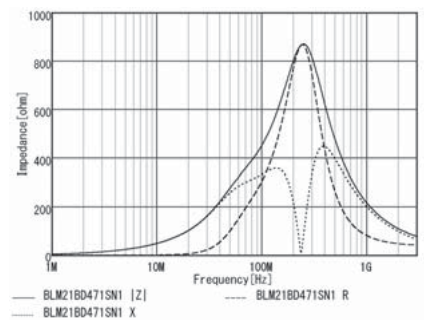

Chip Ferrite Bead
 Application Specified Noise Filter
 Chip EMIFIL®
 Common Mode Choke Coil
 Common Mode Noise Filter
 Block Type EMIFIL®
 EMC Absorber

Continued from the preceding page. ↘

Z-f characteristics

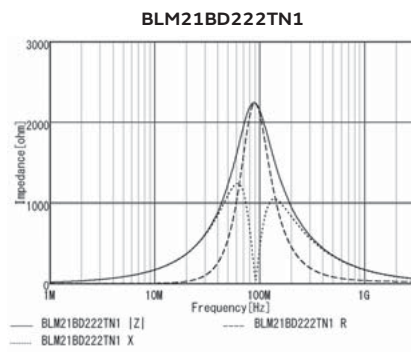
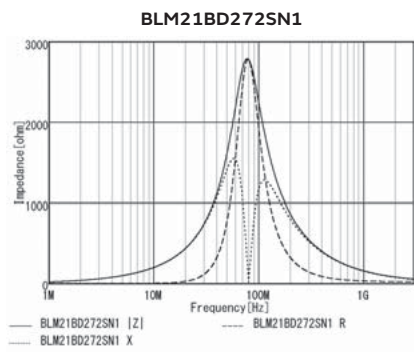
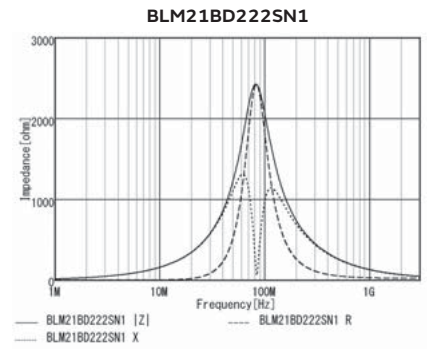
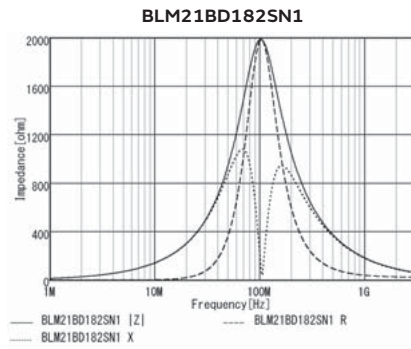
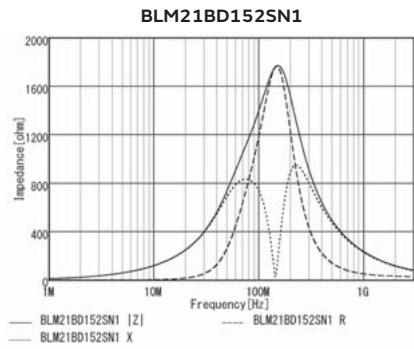
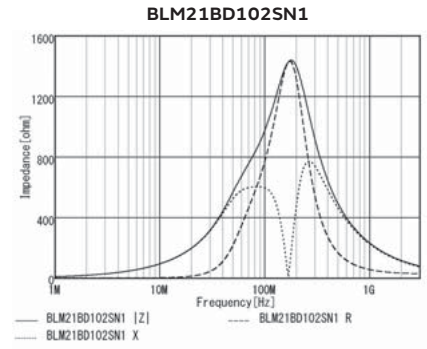
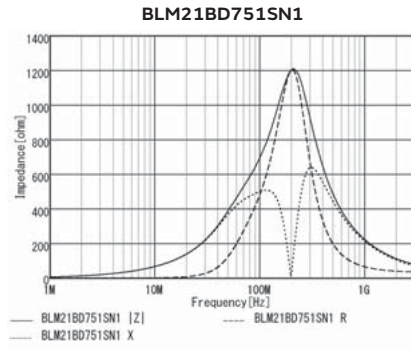
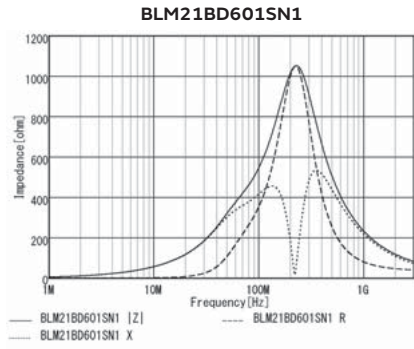

Chip ferrite bead

BLM21RK Series 0805/2012(inch/mm)

Appearance/Dimensions

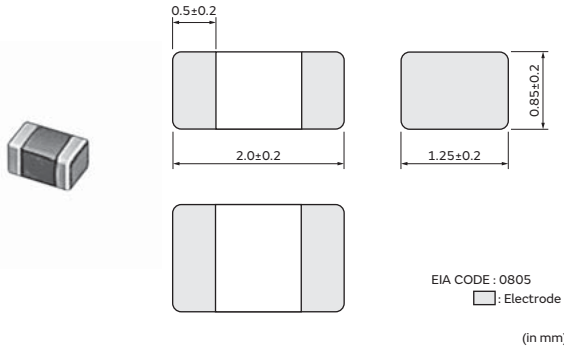

Packaging

Code	Packaging	Minimum Quantity
D	ø180mm Paper Tape	4000
J	ø330mm Paper Tape	10000
B	Bulk(Bag)	1000

Equivalent Circuit



(Resistance element becomes dominant at high frequencies.)

Rated Value (□: packaging code)

Part Number	Impedance at 100MHz	Rated Current at 85°C	Rated Current at 125°C	DC Resistance
BLM21RK121SN1□	120Ω±25%	200mA	200mA	0.15Ω
BLM21RK221SN1□	220Ω±25%	200mA	200mA	0.2Ω
BLM21RK471SN1□	470Ω±25%	200mA	200mA	0.25Ω
BLM21RK601SN1□	600Ω±25%	200mA	200mA	0.3Ω
BLM21RK102SN1□	1000Ω±25%	200mA	200mA	0.5Ω

Operating Temp. Range: -55°C to 125°C

Z-f characteristics

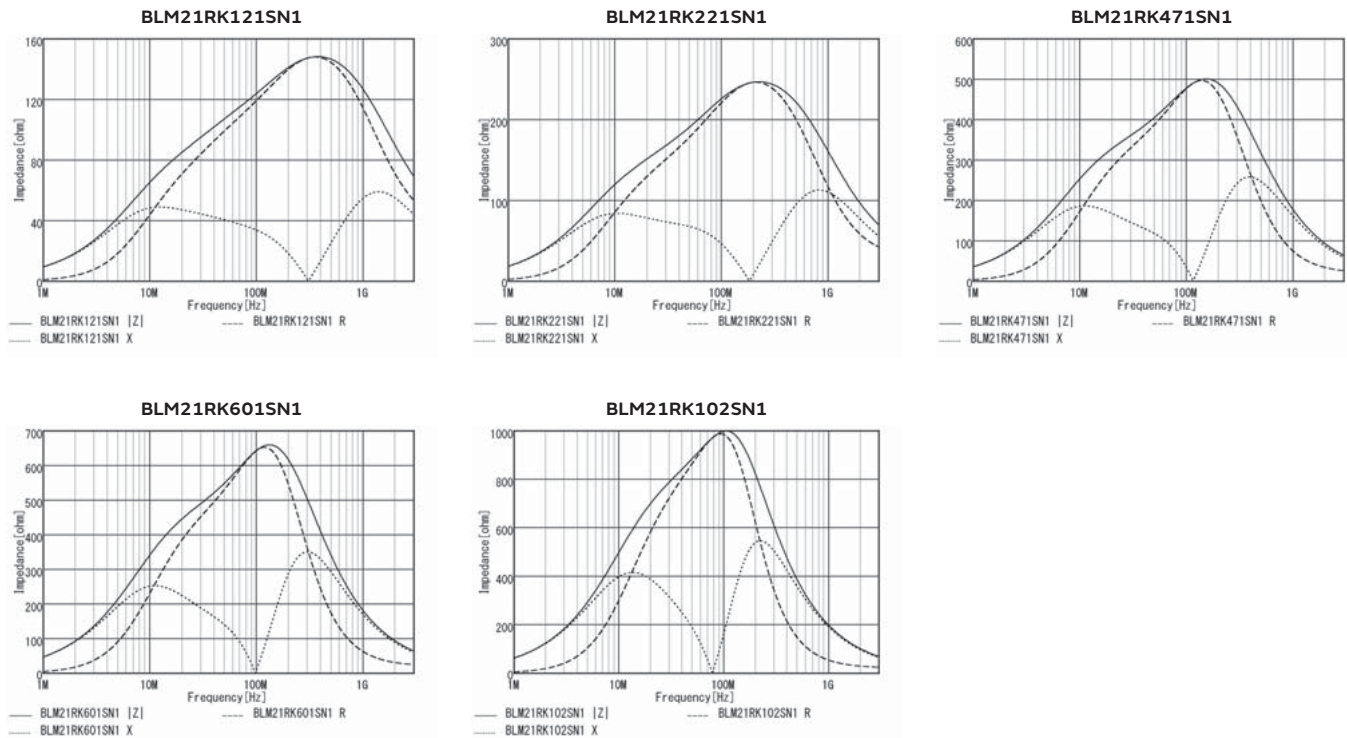

Chip Ferrite Bead

Application Specified Noise Filter

Chip EMIFIL®

Common Mode Choke Coil
 Common Mode Noise Filter

Block Type EMIFIL®

EMC Absorber

Chip ferrite bead

BLM31KN Series 1206/3216(inch/mm)

Appearance/Dimensions

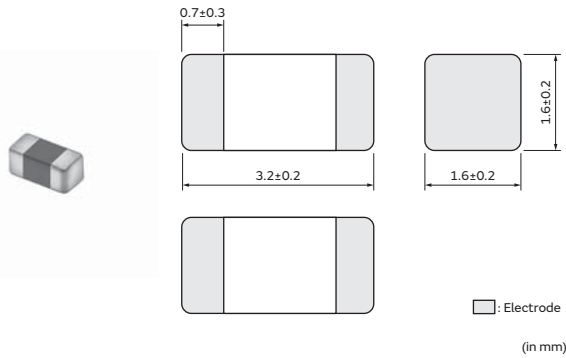

Packaging

Code	Packaging	Minimum Quantity
K	ø330mm Embossed Tape	8000
L	ø180mm Embossed Tape	2500
B	Bulk(Bag)	1000

Equivalent Circuit



(Resistance element becomes dominant at high frequencies.)

Rated Value (□: packaging code)

Part Number	Impedance at 100MHz	Rated Current at 85°C	Rated Current at 125°C	DC Resistance
BLM31KN121SN1□	120Ω±25%	6A	4A	0.009Ω
BLM31KN271SN1□	270Ω±25%	4.5A	3A	0.016Ω
BLM31KN471SN1□	470Ω±25%	4A	2.7A	0.02Ω
BLM31KN601SN1□	600Ω±25%	2.9A	2A	0.038Ω
BLM31KN801SN1□	800Ω±25%	2.5A	1.7A	0.05Ω
BLM31KN102SN1□	1000Ω±25%	2A	1.4A	0.075Ω

Operating Temp. Range: -55°C to 125°C

Z-f characteristics

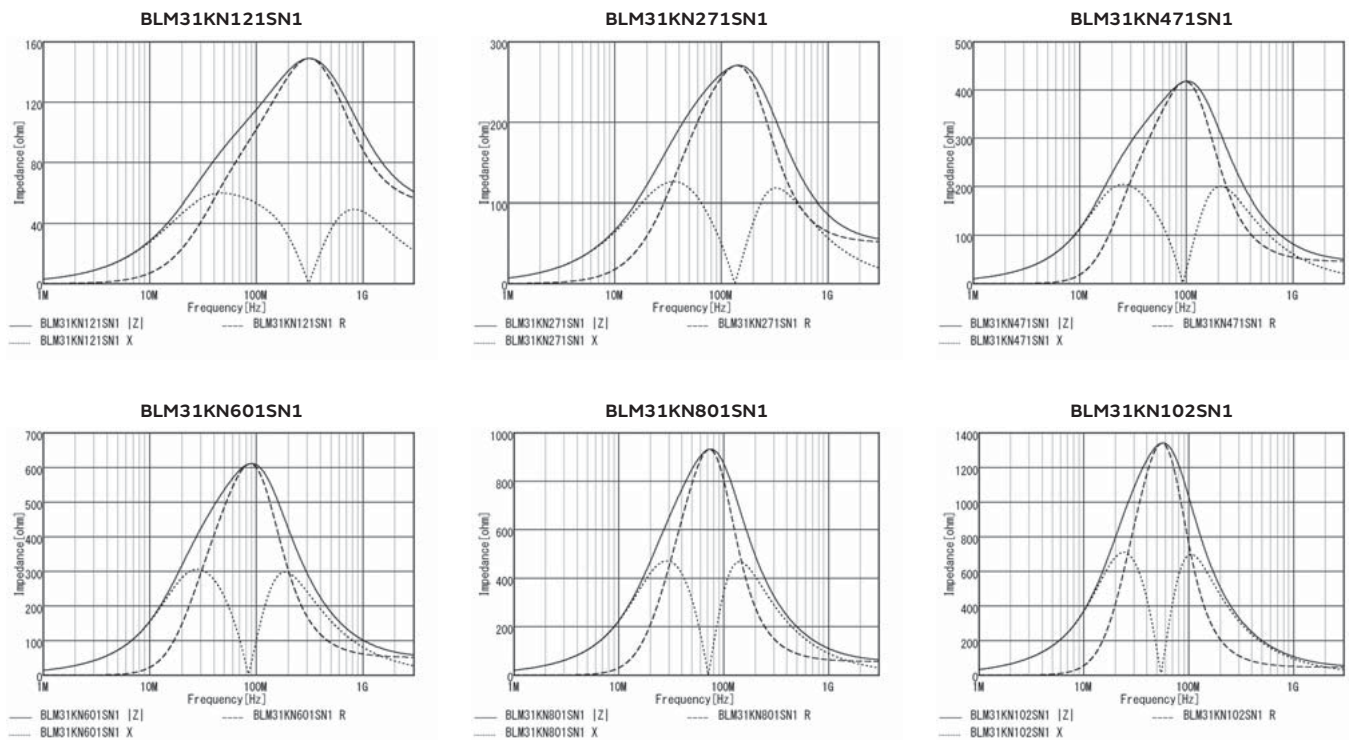

Continued on the following page. ↗

Continued from the preceding page. ↘

Derating of Rated Current

In operating temperature exceeding +85°C, derating of current is necessary for BLM31KN series.
Please apply the derating curve shown in chart according to the operating temperature.

Derating of Rated Current

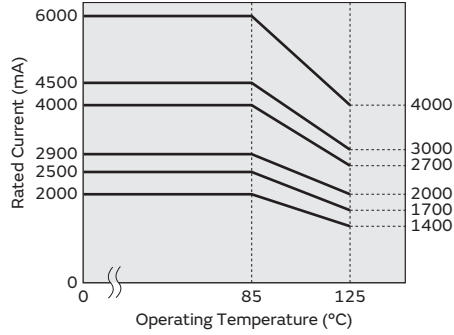

Chip Ferrite Bead

Application Specified Noise Filter

Chip EMIFIL®

Common Mode Choke Coil
Common Mode Noise Filter

Block Type EMIFIL®

EMC Absorber

Chip ferrite bead

BLM31PG Series 1206/3216(inch/mm)

Appearance/Dimensions

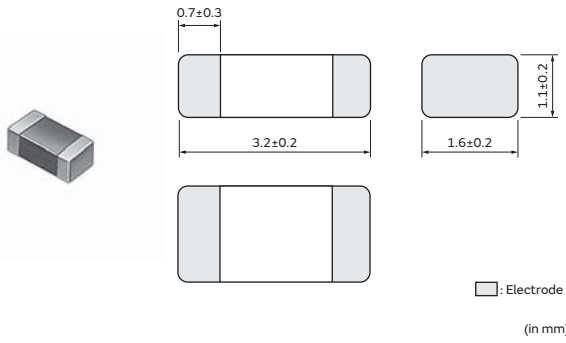

Packaging

Code	Packaging	Minimum Quantity
K	ø330mm Embossed Tape	10000
L	ø180mm Embossed Tape	3000
B	Bulk(Bag)	1000

Equivalent Circuit



(Resistance element becomes dominant at high frequencies.)

Rated Value (□: packaging code)

Part Number	Impedance at 100MHz	Rated Current at 85°C	Rated Current at 125°C	DC Resistance
BLM31PG330SN1□	33Ω±25%	6A	3.5A	0.009Ω
BLM31PG500SN1□	50Ω(Typ.)	3.5A	2.3A	0.015Ω
BLM31PG121SN1□	120Ω±25%	3.5A	2A	0.02Ω
BLM31PG391SN1□	390Ω±25%	2A	1.25A	0.05Ω
BLM31PG601SN1□	600Ω±25%	1.5A	1A	0.08Ω

Operating Temp. Range: -55°C to 125°C

Z-f characteristics

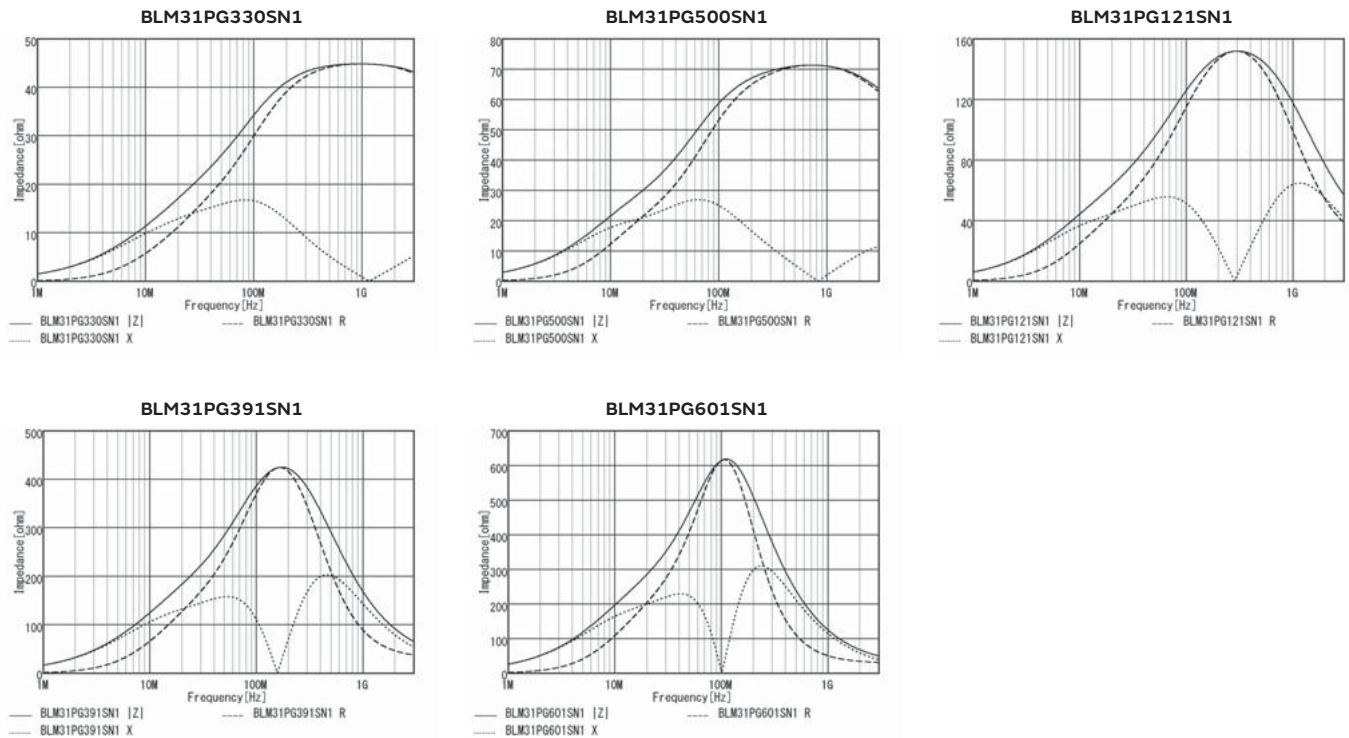

Continued on the following page. ↗

Continued from the preceding page. ↘

Derating of Rated Current

In operating temperature exceeding +85°C, derating of current is necessary for BLM31PG series.
 Please apply the derating curve shown in chart according to the operating temperature.

Derating of Rated Current

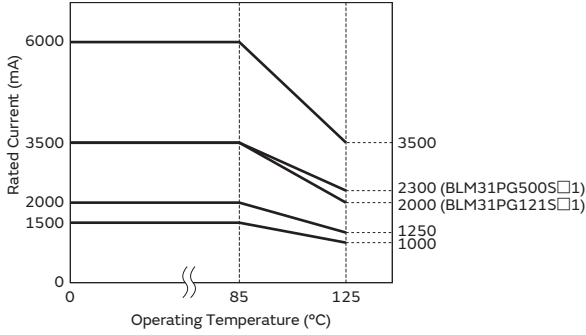

Chip ferrite bead

BLM31SN Series 1206/3216(inch/mm)

Appearance/Dimensions

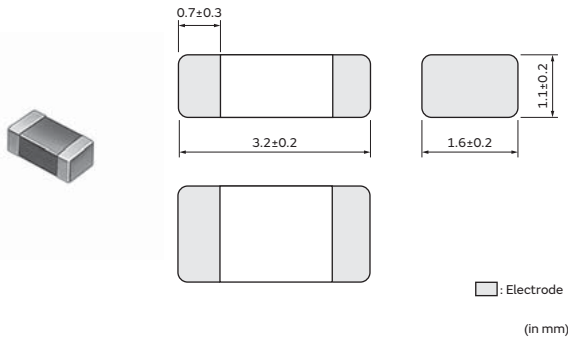

Packaging

Code	Packaging	Minimum Quantity
L	ø180mm Embossed Tape	3000
B	Bulk(Bag)	1000

Equivalent Circuit

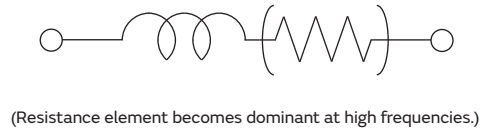

Rated Value (□: packaging code)

Part Number	Impedance at 100MHz	Rated Current at 85°C	Rated Current at 125°C	DC Resistance	Operating Temp. Range
BLM31SN500SN1□	50Ω±12.5Ω	12A	10A	0.0016Ω	-55°C to 125°C

Z-f characteristics

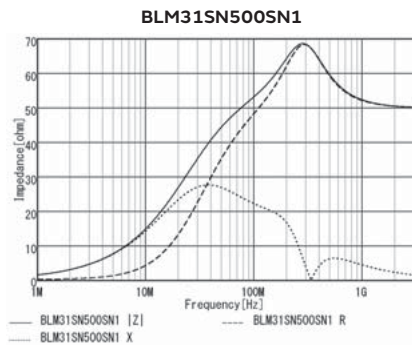

Derating of Rated Current

In operating temperature exceeding +85°C, derating of current is necessary for BLM31SN series. Please apply the derating curve shown in chart according to the operating temperature.

Derating of Rated Current

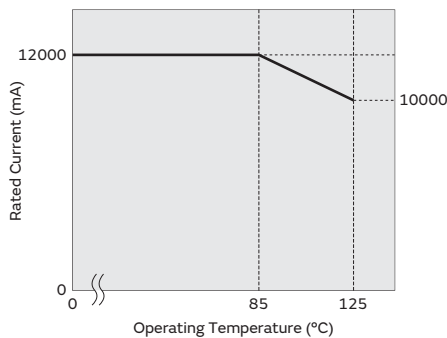

Chip ferrite bead

BLM41PG Series 1806/4516(inch/mm)

Appearance/Dimensions

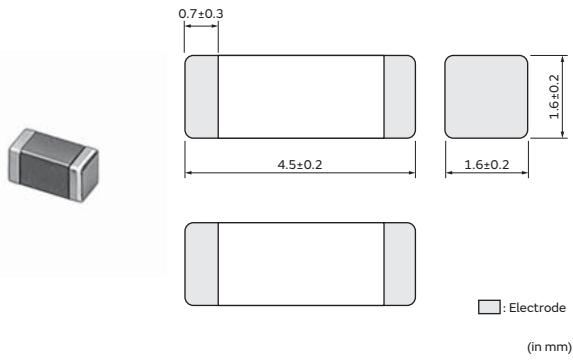

Packaging

Code	Packaging	Minimum Quantity
K	ø330mm Embossed Tape	8000
L	ø180mm Embossed Tape	2500
B	Bulk(Bag)	1000

Equivalent Circuit



(Resistance element becomes dominant at high frequencies.)

Rated Value (□: packaging code)

Part Number	Impedance at 100MHz	Rated Current at 85°C	Rated Current at 125°C	DC Resistance
BLM41PG600SN1□	60Ω(Typ.)	6A	3.7A	0.009Ω
BLM41PG750SN1□	75Ω(Typ.)	3.5A	2.45A	0.015Ω
BLM41PG181SN1□	180Ω±25%	3.5A	2.1A	0.02Ω
BLM41PG471SN1□	470Ω±25%	2A	1.35A	0.05Ω
BLM41PG102SN1□	1000Ω±25%	1.5A	1A	0.09Ω

Operating Temp. Range: -55°C to 125°C

Z-f characteristics

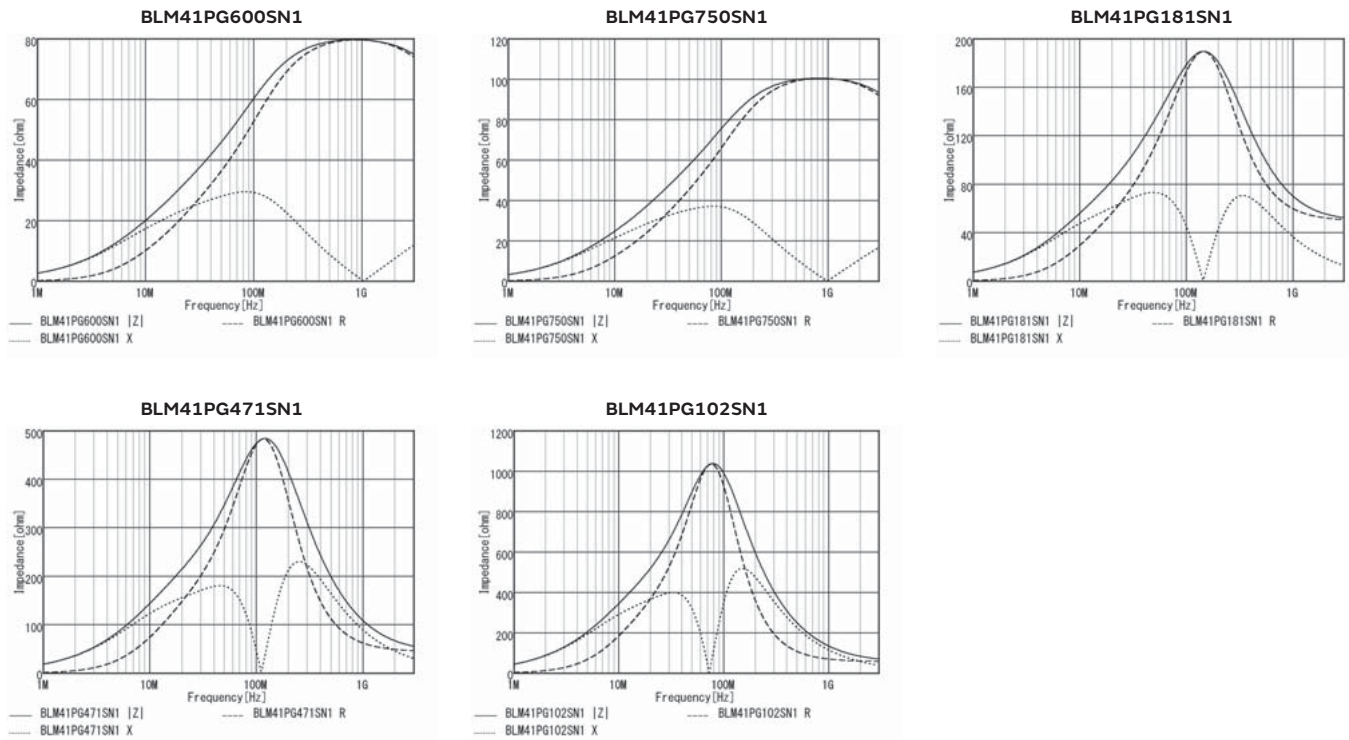

Continued on the following page. ↗

Continued from the preceding page. ↘

Derating of Rated Current

In operating temperature exceeding +85°C, derating of current is necessary for BLM41PG series.
 Please apply the derating curve shown in chart according to the operating temperature.

Derating of Rated Current

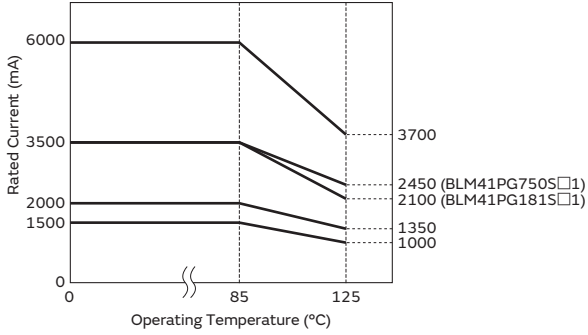

Chip ferrite bead

BLT5BPT_LN1 Series 2020/5050(inch/mm)

Appearance/Dimensions

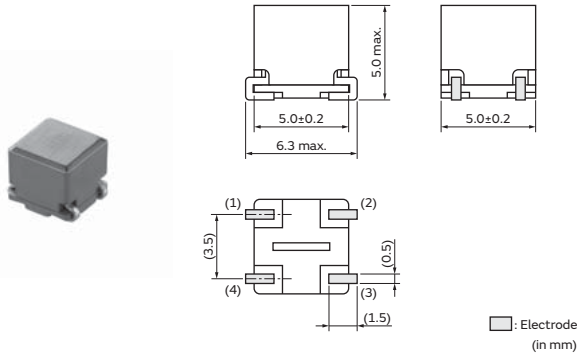

Packaging

Code	Packaging	Minimum Quantity
L	ø180mm Embossed Tape	300
B	Bulk(Bag)	50

Equivalent Circuit

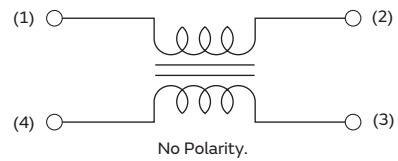

Rated Value (□: packaging code)

Part Number	Impedance at 100MHz	Rated Current at 85°C	Rated Current at 125°C	Rated Current at 150°C	DC Resistance	Operating Temp. Range
BLT5BPT680LN1□	68Ω(Typ.)	11A	7A	4.5A	10mΩ	-55°C to 150°C

Z-f characteristics

BLT5BPT680LN1

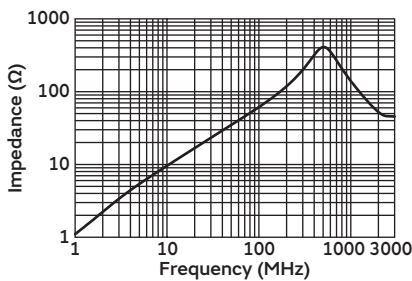

Derating of Rated Current

In operating temperature exceeding +85°C, derating of current is necessary for BLT5BPT_LN1 series. Please apply the derating curve shown in chart according to the operating temperature.

Derating of Rated Current

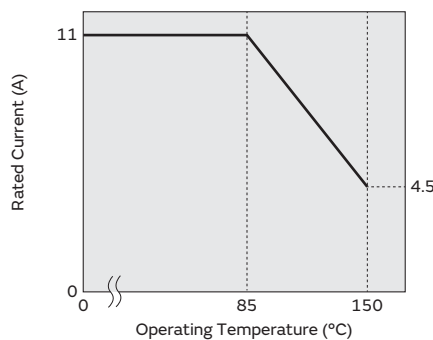

Notification about terminal connection

Connect terminal rightly.
 This product consists of two coils. When it is connected to the same power source line and used as a coil, its inherent properties can be obtained. When it is connected to separate power source lines, serious trouble such as open or short circuit or flames due to extreme heat generation occurs.

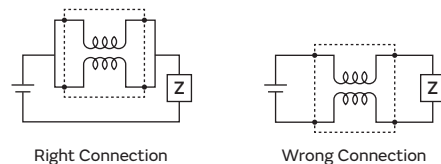

Chip ferrite bead

BLA2AAG Series 0804/2010(inch/mm)

Appearance/Dimensions

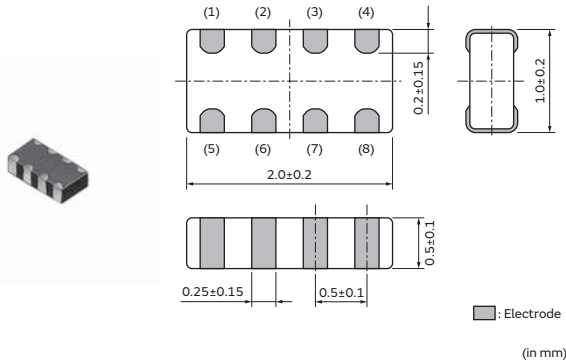

Packaging

Code	Packaging	Minimum Quantity
D	ø180mm Paper Tape	10000
J	ø330mm Paper Tape	50000
B	Bulk(Bag)	1000

Equivalent Circuit

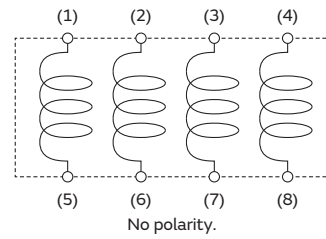

Rated Value (□: packaging code)

Part Number	Impedance at 100MHz	Rated Current at 85°C	Rated Current at 125°C	DC Resistance
BLA2AAG121SN4□	120Ω±25%	100mA	100mA	0.5Ω
BLA2AAG221SN4□	220Ω±25%	50mA	50mA	0.7Ω
BLA2AAG601SN4□	600Ω±25%	50mA	50mA	1.1Ω
BLA2AAG102SN4□	1000Ω±25%	50mA	50mA	1.3Ω

Operating Temp. Range: -55°C to 125°C

Z-f characteristics

BLA2AAG121SN4

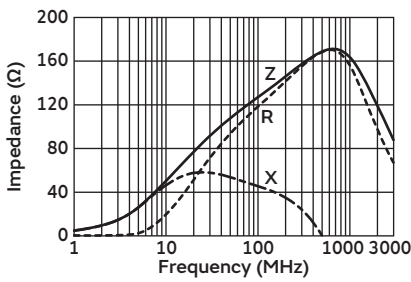

BLA2AAG221SN4

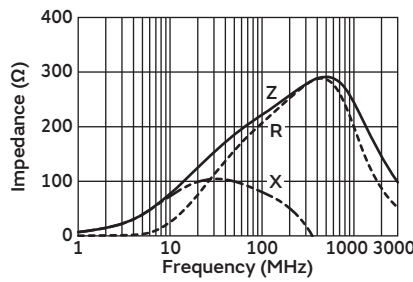

BLA2AAG601SN4

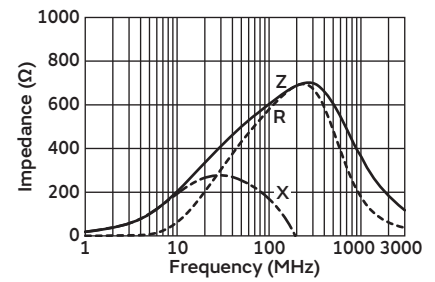

BLA2AAG102SN4

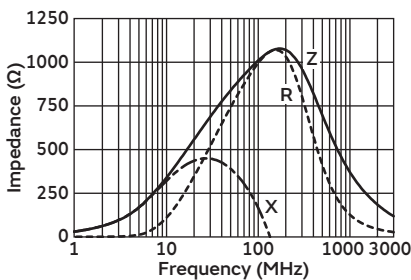

Chip ferrite bead

BLA2ABB/BD Series 0804/2010(inch/mm)

Appearance/Dimensions

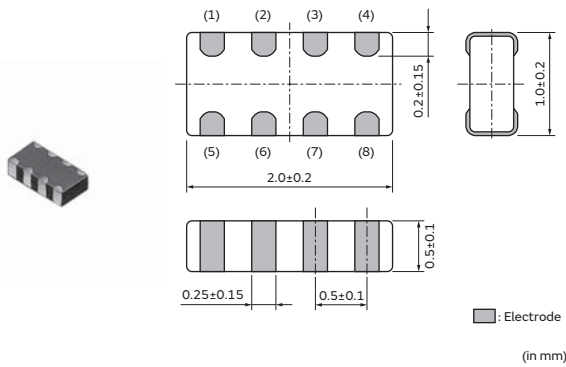

Packaging

Code	Packaging	Minimum Quantity
D	ø180mm Paper Tape	10000
J	ø330mm Paper Tape	50000
B	Bulk(Bag)	1000

Equivalent Circuit

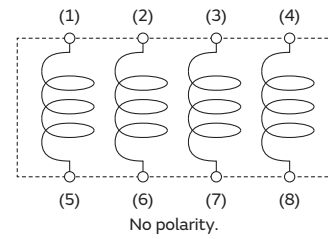

Rated Value (□: packaging code)

Part Number	Impedance at 100MHz	Rated Current at 85°C	Rated Current at 125°C	DC Resistance
BLA2ABB100SN4□	10Ω±25%	200mA	200mA	0.1Ω
BLA2ABB220SN4□	22Ω±25%	200mA	200mA	0.2Ω
BLA2ABB470SN4□	47Ω±25%	200mA	200mA	0.35Ω
BLA2ABB121SN4□	120Ω±25%	50mA	50mA	0.6Ω
BLA2ABB221SN4□	220Ω±25%	50mA	50mA	0.9Ω
BLA2ABD750SN4□	75Ω±25%	200mA	200mA	0.2Ω
BLA2ABD121SN4□	120Ω±25%	200mA	200mA	0.35Ω
BLA2ABD221SN4□	220Ω±25%	100mA	100mA	0.4Ω
BLA2ABD471SN4□	470Ω±25%	100mA	100mA	0.65Ω
BLA2ABD601SN4□	600Ω±25%	100mA	100mA	0.8Ω
BLA2ABD102SN4□	1000Ω±25%	50mA	50mA	1Ω

Operating Temp. Range: -55°C to 125°C

Z-f characteristics

BLA2ABB100SN4

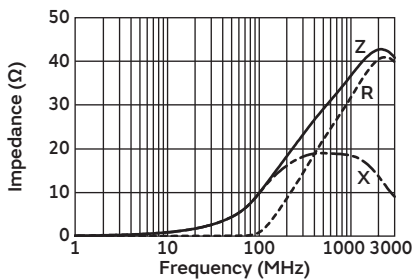

BLA2ABB220SN4

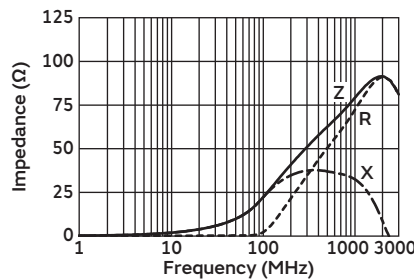

BLA2ABB470SN4

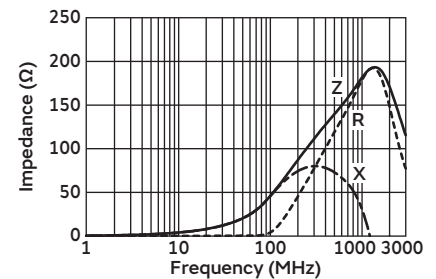

Continued on the following page. ↗

Continued from the preceding page. ↘

Z-f characteristics

BLA2ABB121SN4

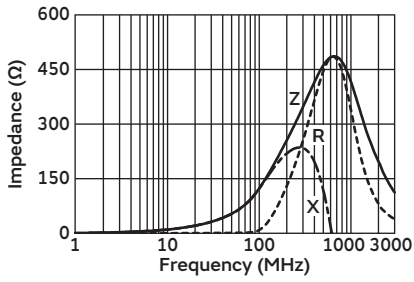

BLA2ABB221SN4

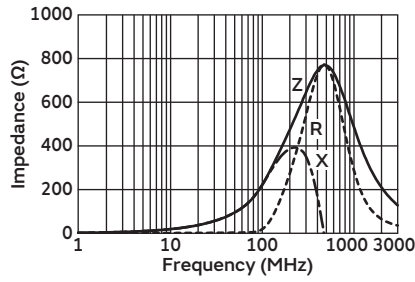

BLA2ABD750SN4

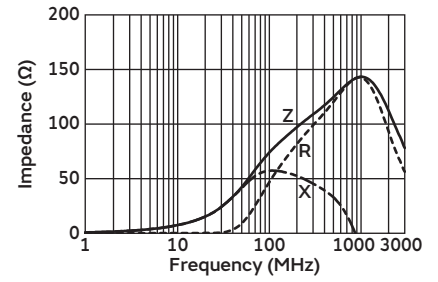

BLA2ABD121SN4

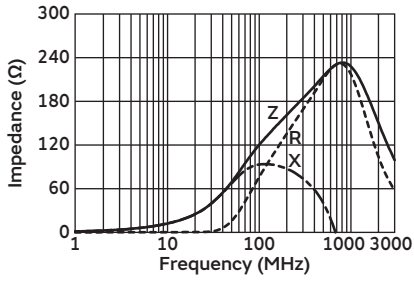

BLA2ABD221SN4

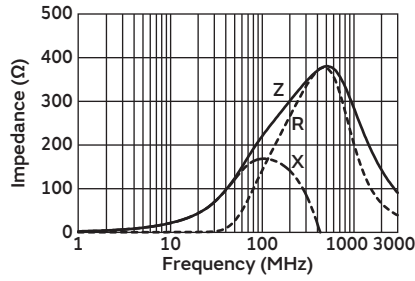

BLA2ABD471SN4

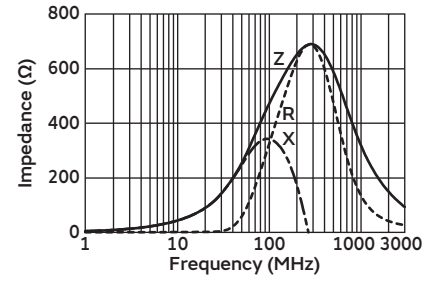

BLA2ABD601SN4

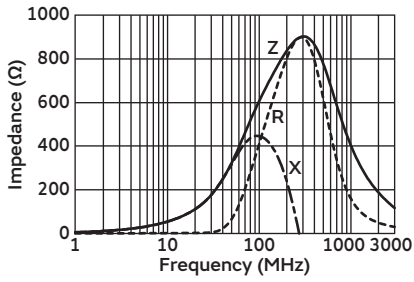

BLA2ABD102SN4

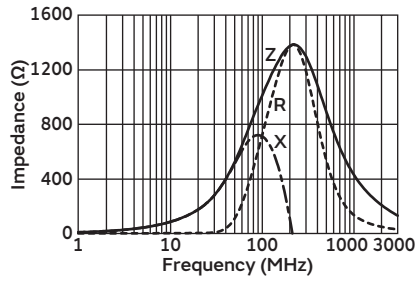

Chip ferrite bead

BLA31AG Series 1206/3216(inch/mm)

Appearance/Dimensions

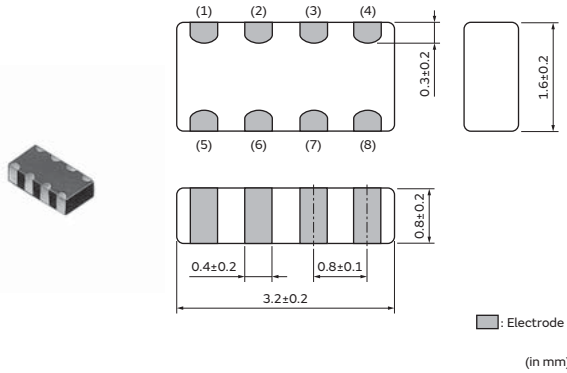

Packaging

Code	Packaging	Minimum Quantity
D	ø180mm Paper Tape	4000
J	ø330mm Paper Tape	10000
B	Bulk(Bag)	1000

Equivalent Circuit

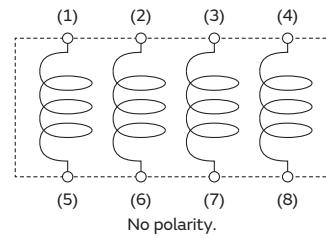

Rated Value (□: packaging code)

Part Number	Impedance at 100MHz	Rated Current at 85°C	Rated Current at 125°C	DC Resistance
BLA31AG300SN4□	30Ω±25%	200mA	200mA	0.1Ω
BLA31AG600SN4□	60Ω±25%	200mA	200mA	0.15Ω
BLA31AG121SN4□	120Ω±25%	150mA	150mA	0.2Ω
BLA31AG221SN4□	220Ω±25%	150mA	150mA	0.25Ω
BLA31AG601SN4□	600Ω±25%	100mA	100mA	0.35Ω
BLA31AG102SN4□	1000Ω±25%	50mA	50mA	0.45Ω

Operating Temp. Range: -55°C to 125°C

Z-f characteristics

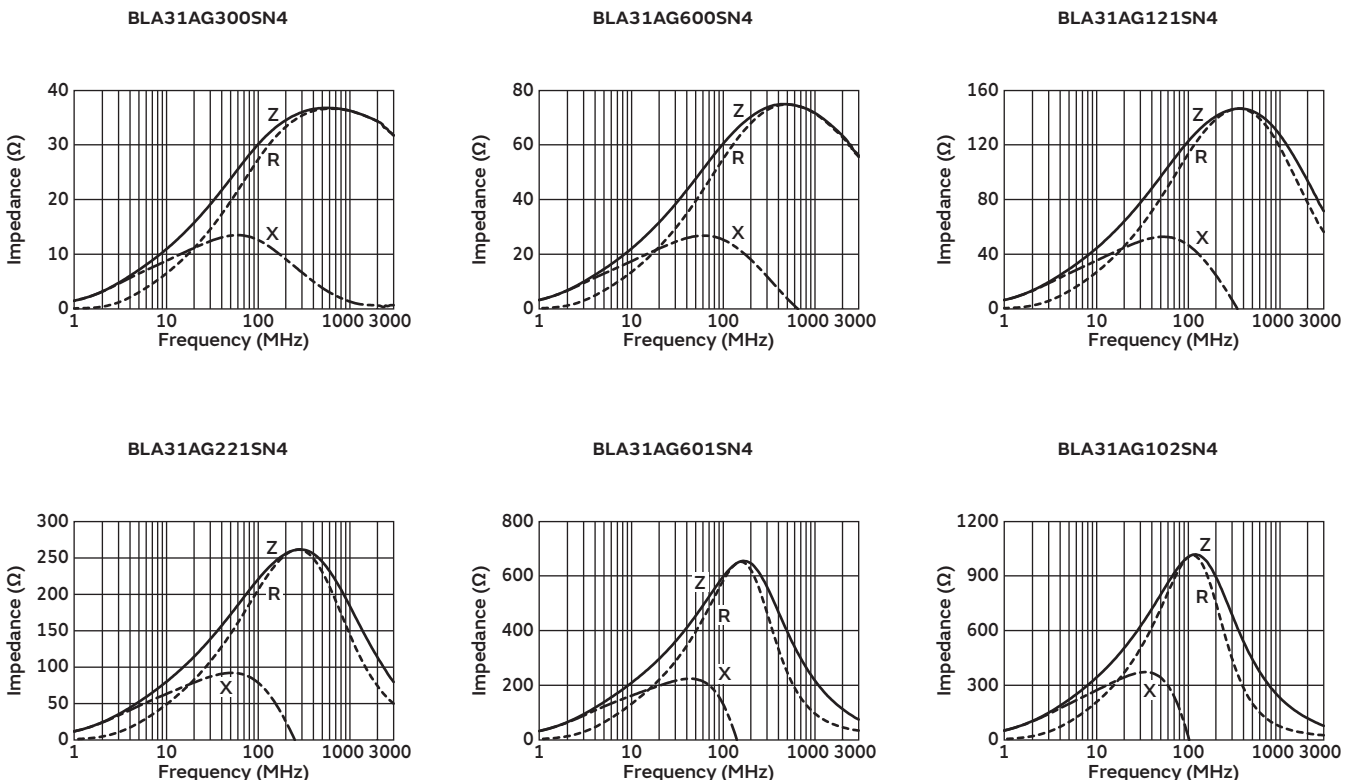

Chip Ferrite Bead
 Application Specified Noise Filter
 Chip EMIFIL®
 Common Mode Choke Coil
 Common Mode Noise Filter
 Block Type EMIFIL®
 EMC Absorber

Chip ferrite bead

BLA31BD Series 1206/3216(inch/mm)

Appearance/Dimensions

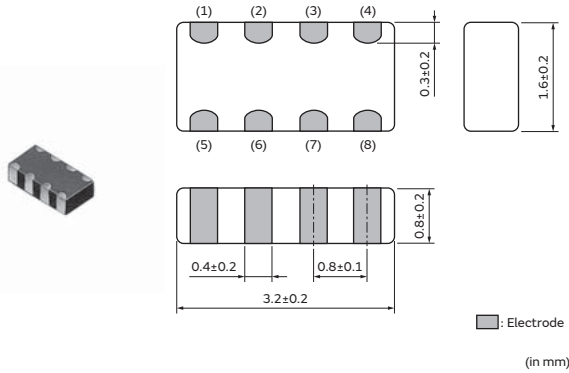

Packaging

Code	Packaging	Minimum Quantity
D	ø180mm Paper Tape	4000
J	ø330mm Paper Tape	10000
B	Bulk(Bag)	1000

Equivalent Circuit

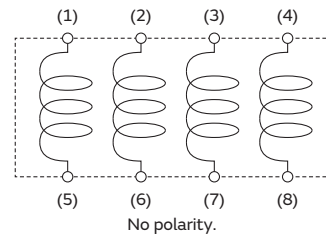

Rated Value (□: packaging code)

Part Number	Impedance at 100MHz	Rated Current at 85°C	Rated Current at 125°C	DC Resistance
BLA31BD121SN4□	120Ω±25%	150mA	150mA	0.3Ω
BLA31BD221SN4□	220Ω±25%	150mA	150mA	0.35Ω
BLA31BD471SN4□	470Ω±25%	100mA	100mA	0.4Ω
BLA31BD601SN4□	600Ω±25%	100mA	100mA	0.45Ω
BLA31BD102SN4□	1000Ω±25%	50mA	50mA	0.55Ω

Operating Temp. Range: -55°C to 125°C

Z-f characteristics

BLA31BD121SN4

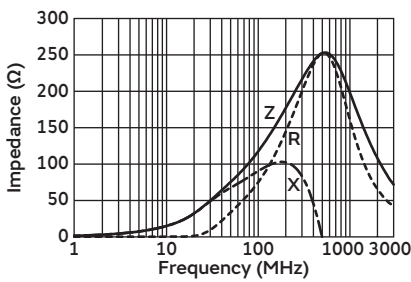

BLA31BD221SN4

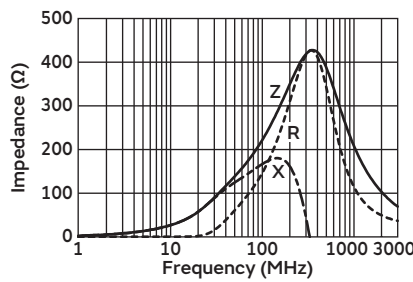

BLA31BD471SN4

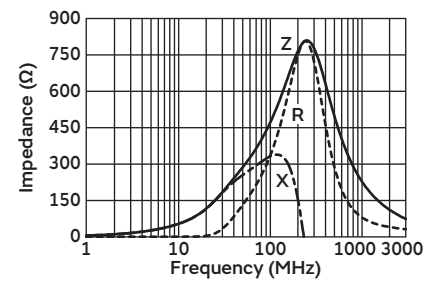

BLA31BD601SN4

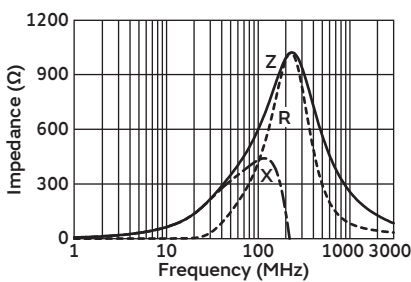

BLA31BD102SN4

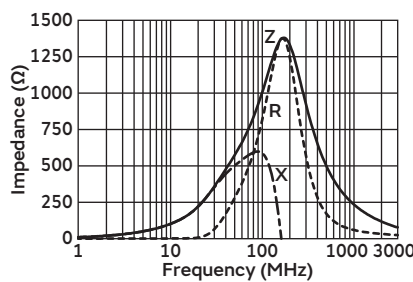

Chip ferrite bead

BLM03HB/HD/HG Series 0201/0603(inch/mm)

Appearance/Dimensions

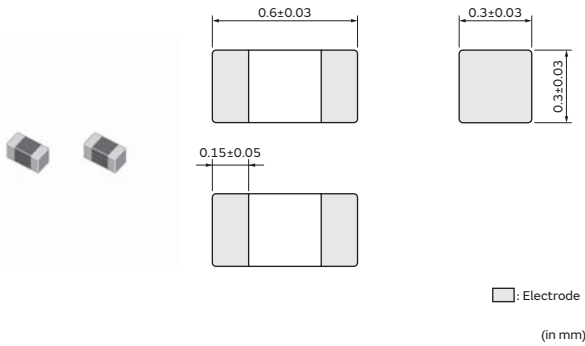

Packaging

Code	Packaging	Minimum Quantity
D	ø180mm Paper Tape	15000
J	ø330mm Paper Tape	50000
B	Bulk(Bag)	1000

Equivalent Circuit



(Resistance element becomes dominant at high frequencies.)

Rated Value (□: packaging code)

Part Number	Impedance at 100MHz	Impedance at 1GHz	Rated Current at 85°C	Rated Current at 125°C	DC Resistance
BLM03HB191SN1□	190Ω±25%	1150Ω±40%	150mA	150mA	2Ω
BLM03HB401SN1□	400Ω±25%	1850Ω±40%	125mA	125mA	2.8Ω
BLM03HD102FN1□	1000Ω±25%	2300Ω±40%	135mA	135mA	2.4Ω
BLM03HD152FN1□	1500Ω±25%	2700Ω±40%	120mA	120mA	3.1Ω
BLM03HD182FN1□	1800Ω±25%	3000Ω±40%	100mA	100mA	3.8Ω
BLM03HD331SN1□	330Ω±25%	750Ω±40%	200mA	200mA	1Ω
BLM03HD471SN1□	470Ω±25%	1000Ω±40%	175mA	175mA	1.3Ω
BLM03HD601SN1□	600Ω±25%	1500Ω±40%	150mA	150mA	1.7Ω
BLM03HD102SN1□	1000Ω±25%	2300Ω±40%	120mA	120mA	2.9Ω
BLM03HG601SN1□	600Ω±25%	1000Ω±40%	150mA	150mA	1.6Ω
BLM03HG102SN1□	1000Ω±25%	1800Ω±40%	125mA	125mA	2.6Ω
BLM03HG122SN1□	1200Ω±25%	2000Ω±40%	100mA	100mA	3.5Ω

Operating Temp. Range: -55°C to 125°C

Z-f characteristics

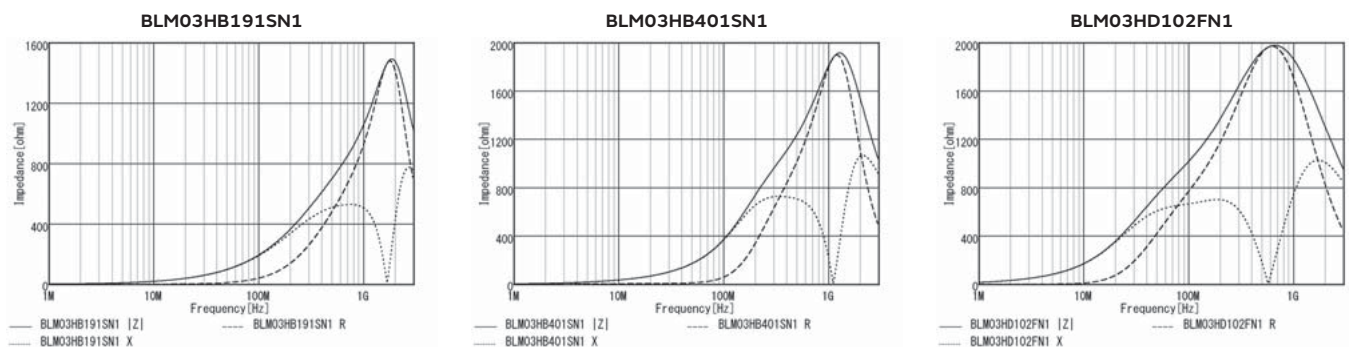

Continued on the following page. ↗

Chip Ferrite Bead

Application Specified Noise Filter

Chip EMIFIL®

Common Mode Choke Coil
 Common Mode Noise Filter

Block Type EMIFIL®

EMC Absorber

Continued from the preceding page. ↘

Z-f characteristics

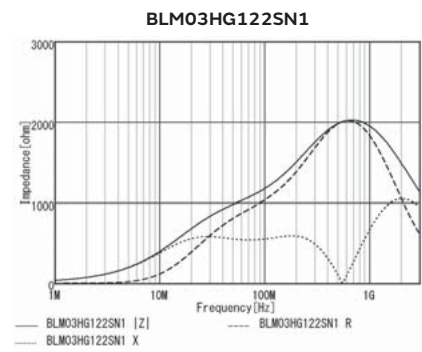
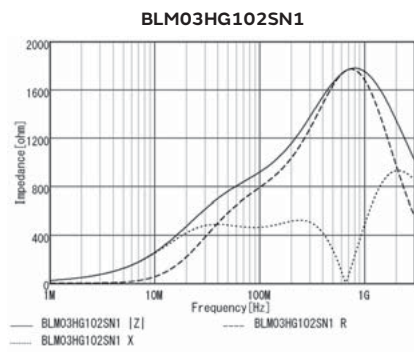
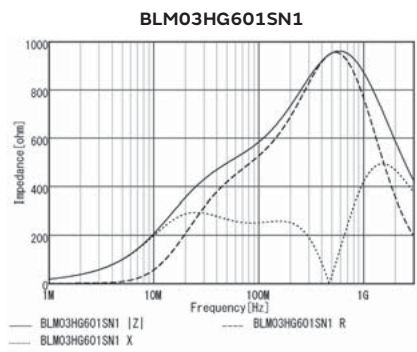
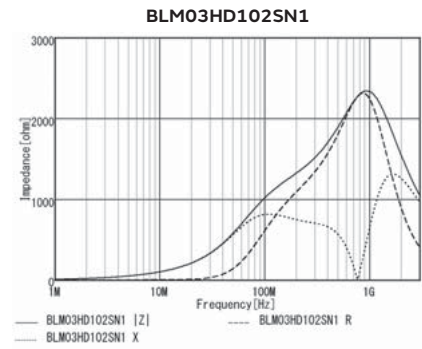
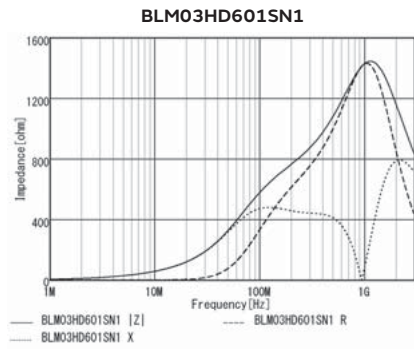
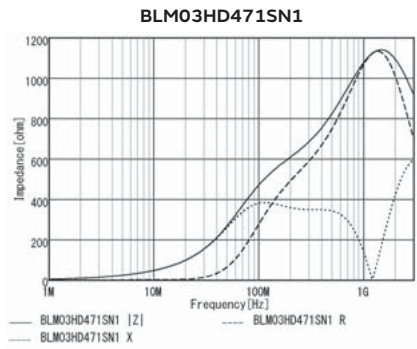
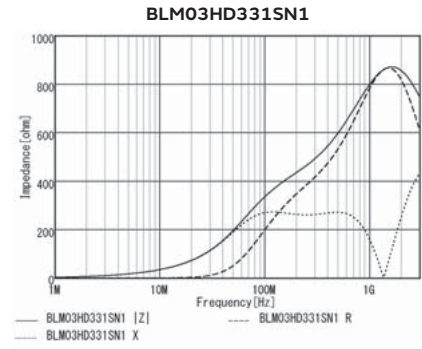
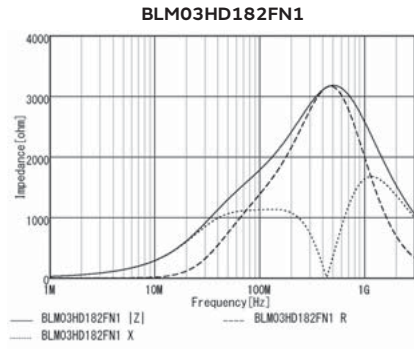
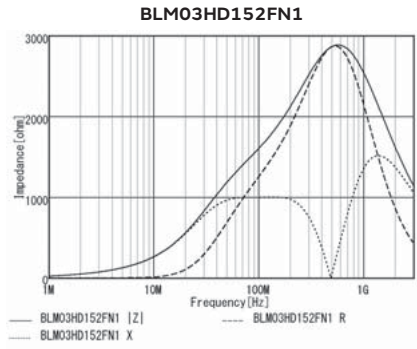

Chip ferrite bead

BLM03EB Series 0201/0603(inch/mm)

Appearance/Dimensions

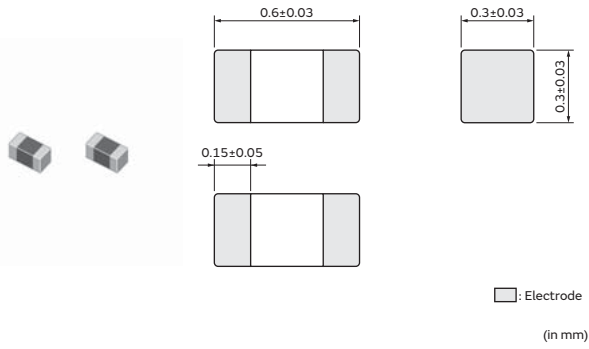

Packaging

Code	Packaging	Minimum Quantity
D	ø180mm Paper Tape	15000
J	ø330mm Paper Tape	50000
B	Bulk(Bag)	1000

Equivalent Circuit



(Resistance element becomes dominant at high frequencies.)

Rated Value (□: packaging code)

Part Number	Impedance at 100MHz	Impedance at 1GHz	Rated Current at 85°C	Rated Current at 125°C	DC Resistance
BLM03EB250SN1□	25Ω±25%	105Ω±40%	600mA	450mA	0.26Ω
BLM03EB500SN1□	50Ω±25%	255Ω±40%	400mA	300mA	0.58Ω

Operating Temp. Range: -55°C to 125°C

Z-f characteristics

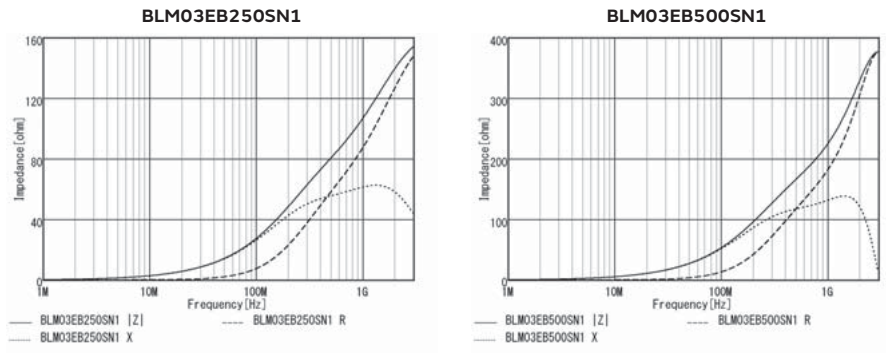

Derating of Rated Current

In operating temperature exceeding +85°C, derating of current is necessary for BLM03E series.
 Please apply the derating curve shown in chart according to the operating temperature.

Derating of Rated Current

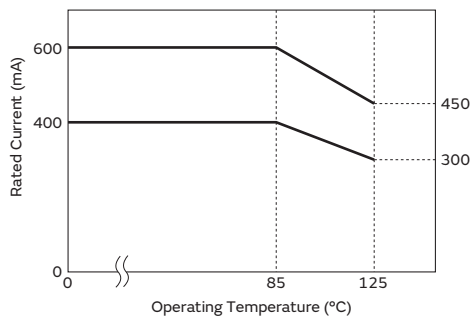

Chip Ferrite Bead
Application Specified Noise Filter
Chip EMIFIL®
Common Mode Choke Coil
Common Mode Noise Filter
Block Type EMIFIL®
EMC Absorber

Chip ferrite bead

BLM15HB/HD/HG Series 0402/1005(inch/mm)

Appearance/Dimensions

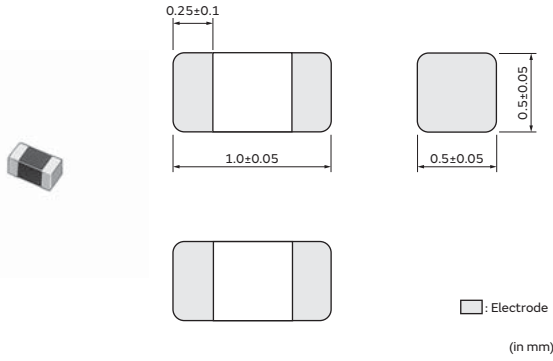

Packaging

Code	Packaging	Minimum Quantity
D	ø180mm Paper Tape	10000
J	ø330mm Paper Tape	50000
B	Bulk(Bag)	1000

Equivalent Circuit



(Resistance element becomes dominant at high frequencies.)

Rated Value (□: packaging code)

Part Number	Impedance at 100MHz	Impedance at 1GHz	Rated Current at 85°C	Rated Current at 125°C	DC Resistance
BLM15HB121SN1□	120Ω±25%	500Ω±40%	300mA	300mA	0.7Ω
BLM15HB221SN1□	220Ω±25%	900Ω±40%	250mA	250mA	1Ω
BLM15HD601SN1□	600Ω±25%	1400Ω±40%	300mA	300mA	0.85Ω
BLM15HD102SN1□	1000Ω±25%	2000Ω±40%	250mA	250mA	1.25Ω
BLM15HD182SN1□	1800Ω±25%	2700Ω±40%	200mA	200mA	2.2Ω
BLM15HG601SN1□	600Ω±25%	1000Ω±40%	300mA	300mA	0.7Ω
BLM15HG102SN1□	1000Ω±25%	1400Ω±40%	250mA	250mA	1.1Ω

Operating Temp. Range: -55°C to 125°C

Z-f characteristics

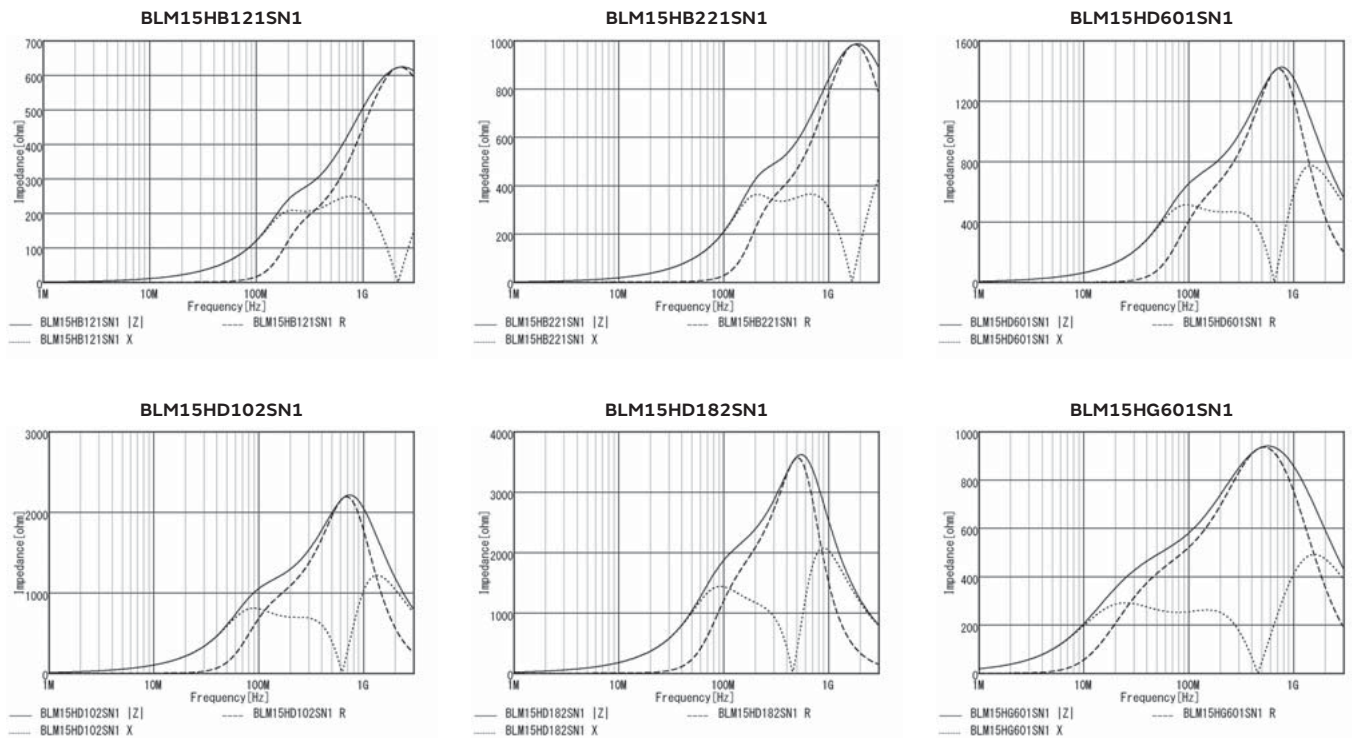

Continued on the following page. ↗

Continued from the preceding page. ↘

Z-f characteristics

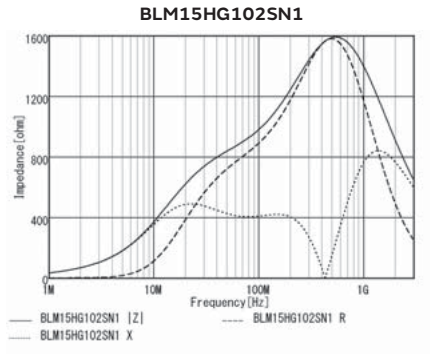

Chip Ferrite Bead

Application Specified Noise Filter

Chip EMIFIL®

Common Mode Choke Coil
Common Mode Noise Filter

Block Type EMIFIL®

EMC Absorber

Chip ferrite bead

BLM15EG Series 0402/1005(inch/mm)

Appearance/Dimensions

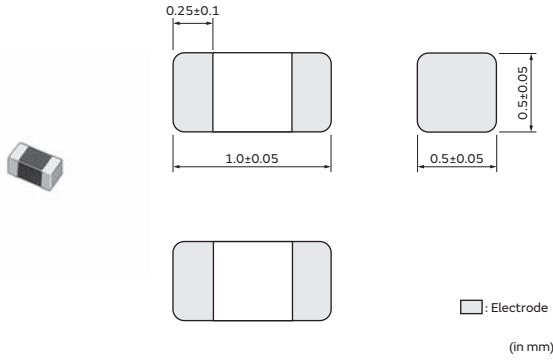

Packaging

Code	Packaging	Minimum Quantity
D	ø180mm Paper Tape	10000
J	ø330mm Paper Tape	50000
B	Bulk(Bag)	1000

Equivalent Circuit



(Resistance element becomes dominant at high frequencies.)

Rated Value (□: packaging code)

Part Number	Impedance at 100MHz	Impedance at 1GHz	Rated Current at 85°C	Rated Current at 125°C	DC Resistance
BLM15EG121SN1□	120Ω±25%	145Ω(Typ.)	1.5A	900mA	0.095Ω
BLM15EG221SN1□	220Ω±25%	270Ω(Typ.)	700mA	500mA	0.28Ω

Operating Temp. Range: -55°C to 125°C

Z-f characteristics

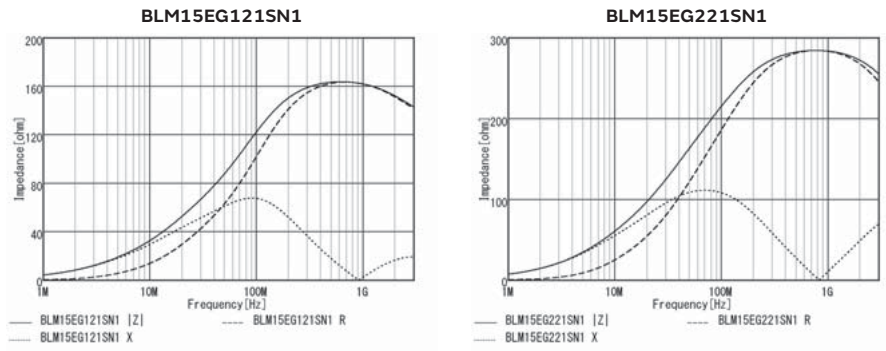

Derating of Rated Current

In operating temperature exceeding +85°C, derating of current is necessary for BLM15E series. Please apply the derating curve shown in chart according to the operating temperature.

Derating of Rated Current

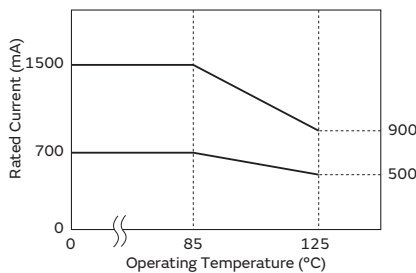

Chip ferrite bead

BLM15EX Series 0402/1005(inch/mm)

Appearance/Dimensions

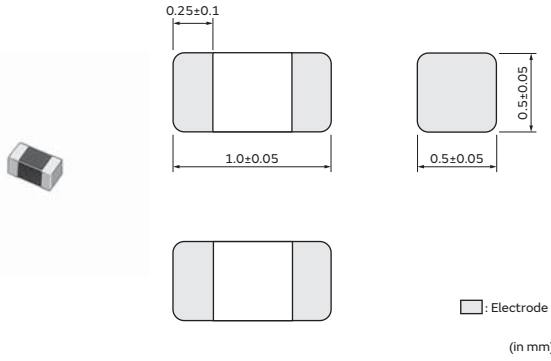

Packaging

Code	Packaging	Minimum Quantity
D	ø180mm Paper Tape	10000
J	ø330mm Paper Tape	50000
B	Bulk(Bag)	1000

Equivalent Circuit



(Resistance element becomes dominant at high frequencies.)

Rated Value (□: packaging code)

Part Number	Impedance at 100MHz	Impedance at 1GHz	Rated Current at 85°C	Rated Current at 125°C	DC Resistance
BLM15EX121SN1□	120Ω±25%	170Ω±40%	1.8A	1.2A	0.075Ω
BLM15EX221SN1□	220Ω±25%	300Ω±40%	1.3A	850mA	0.14Ω
BLM15EX331SN1□	330Ω±25%	450Ω±40%	1.1A	700mA	0.205Ω
BLM15EX471SN1□	470Ω±25%	630Ω±40%	950mA	600mA	0.28Ω

Operating Temp. Range: -55°C to 125°C

Z-f characteristics

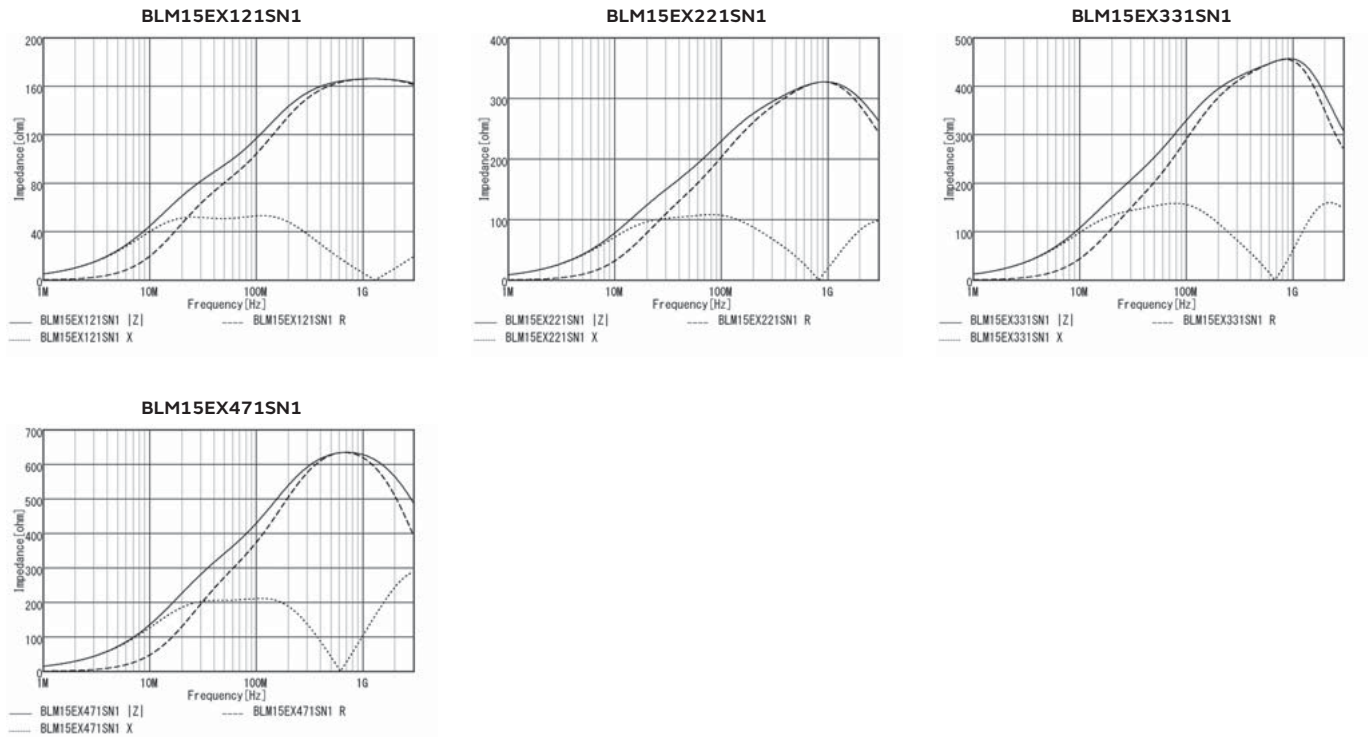

Continued on the following page. ↗

Continued from the preceding page. ↘

Derating of Rated Current

In operating temperature exceeding +85°C, derating of current is necessary for BLM15EX series.
Please apply the derating curve shown in chart according to the operating temperature.

Derating of Rated Current

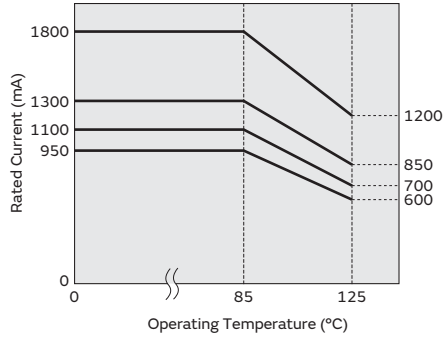

Chip ferrite bead

BLM15GA/GG Series 0402/1005(inch/mm)

Appearance/Dimensions

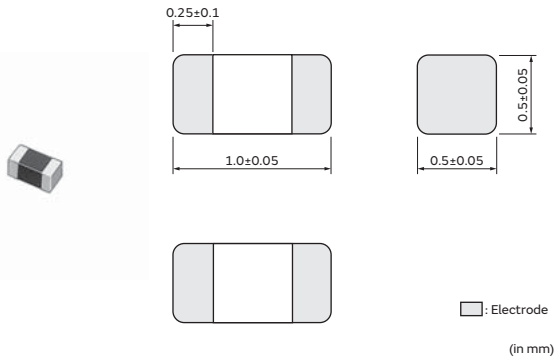

Packaging

Code	Packaging	Minimum Quantity
D	ø180mm Paper Tape	10000
J	ø330mm Paper Tape	50000
B	Bulk(Bag)	1000

Equivalent Circuit



(Resistance element becomes dominant at high frequencies.)

Rated Value (□: packaging code)

Part Number	Impedance at 100MHz	Impedance at 1GHz	Rated Current at 85°C	Rated Current at 125°C	DC Resistance
BLM15GA750SN1□	75Ω±25%	1000Ω±40%	200mA	200mA	1.3Ω
BLM15GG221SN1□	220Ω±25%	600Ω±40%	300mA	300mA	0.7Ω
BLM15GG471SN1□	470Ω±25%	1200Ω±40%	200mA	200mA	1.3Ω

Operating Temp. Range: -55°C to 125°C

Z-f characteristics

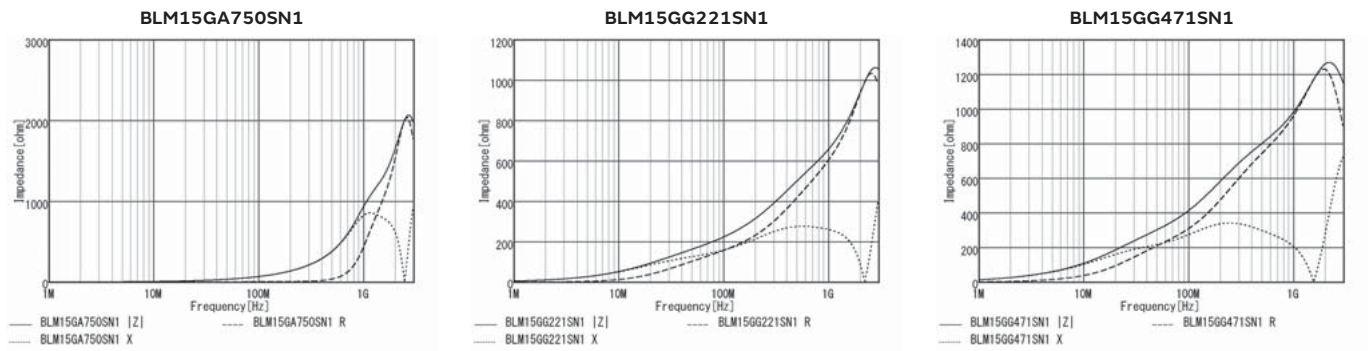

Chip ferrite bead

BLM18HB/HD/HE/HG/HK Series 0603/1608(inch/mm)

Appearance/Dimensions

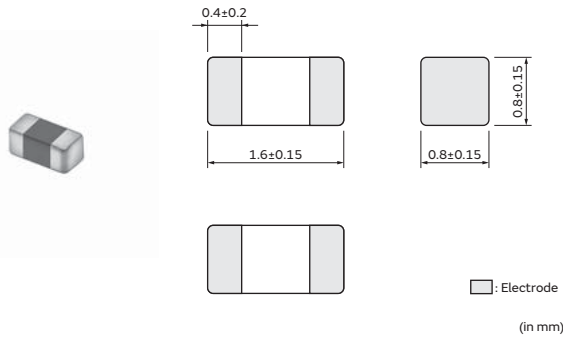

Packaging

Code	Packaging	Minimum Quantity
D	ø180mm Paper Tape	4000
J	ø330mm Paper Tape	10000
B	Bulk(Bag)	1000

Equivalent Circuit



(Resistance element becomes dominant at high frequencies.)

Rated Value (□: packaging code)

Part Number	Impedance at 100MHz	Impedance at 1GHz	Rated Current at 85°C	Rated Current at 125°C	DC Resistance
BLM18HB121SN1□	120Ω±25%	500Ω±40%	200mA	200mA	0.5Ω
BLM18HB221SN1□	220Ω±25%	1100Ω±40%	100mA	100mA	0.8Ω
BLM18HB331SN1□	330Ω±25%	1600Ω±40%	50mA	50mA	1.2Ω
BLM18HD471SN1□	470Ω±25%	1000Ω(Typ.)	100mA	100mA	1.2Ω
BLM18HD601SN1□	600Ω±25%	1200Ω(Typ.)	100mA	100mA	1.5Ω
BLM18HD102SN1□	1000Ω±25%	1700Ω(Typ.)	50mA	50mA	1.8Ω
BLM18HE601SN1□	600Ω±25%	600Ω(Typ.)	800mA	600mA	0.25Ω
BLM18HE102SN1□	1000Ω±25%	1000Ω(Typ.)	600mA	500mA	0.35Ω
BLM18HE152SN1□	1500Ω±25%	1500Ω(Typ.)	500mA	400mA	0.5Ω
BLM18HG471SN1□	470Ω±25%	600Ω(Typ.)	200mA	200mA	0.85Ω
BLM18HG601SN1□	600Ω±25%	700Ω(Typ.)	200mA	200mA	1Ω
BLM18HG102SN1□	1000Ω±25%	1000Ω(Typ.)	100mA	100mA	1.6Ω
BLM18HK331SN1□	330Ω±25%	400Ω±40%	200mA	200mA	0.5Ω
BLM18HK471SN1□	470Ω±25%	600Ω±40%	200mA	200mA	0.7Ω
BLM18HK601SN1□	600Ω±25%	700Ω±40%	100mA	100mA	0.9Ω
BLM18HK102SN1□	1000Ω±25%	1200Ω±40%	50mA	50mA	1.5Ω

Operating Temp. Range: -55°C to 125°C

Z-f characteristics

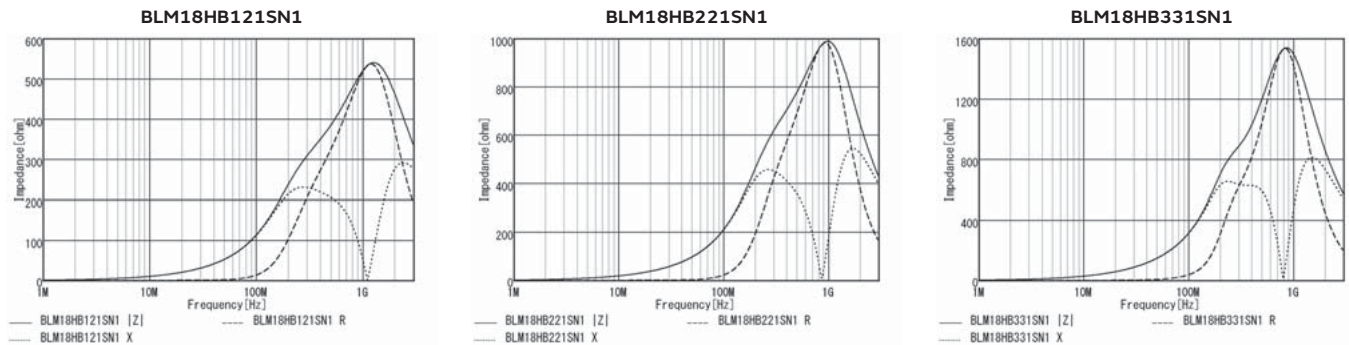

Continued on the following page. ↗

Continued from the preceding page. ↘

Z-f characteristics

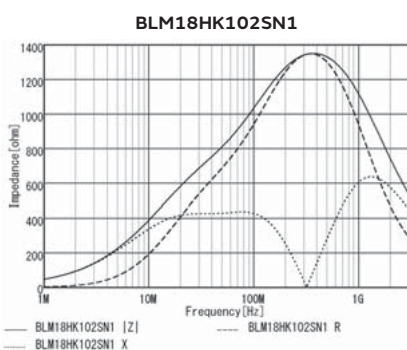
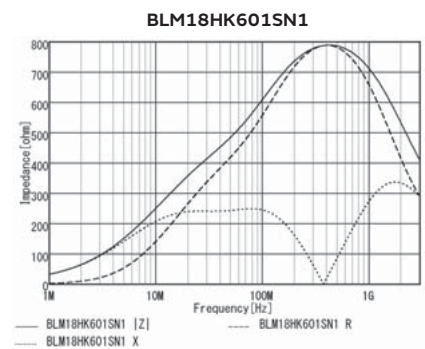
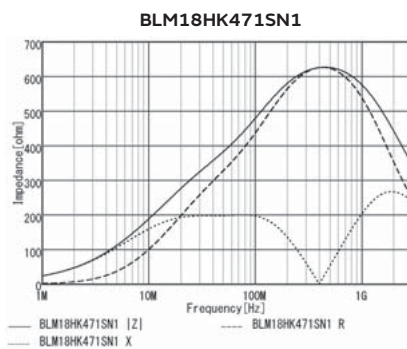
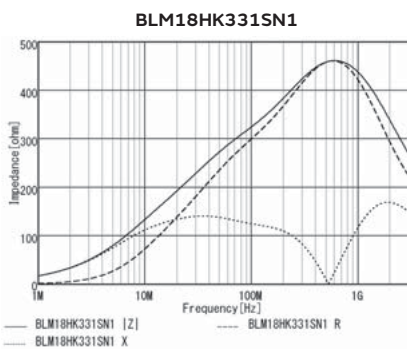
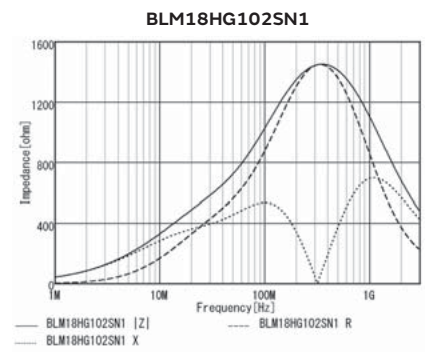
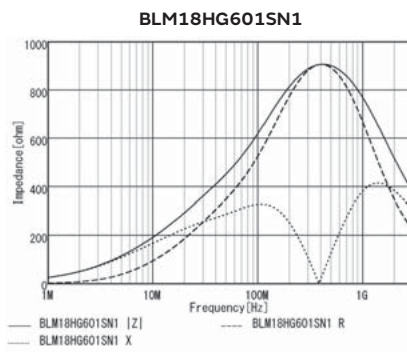
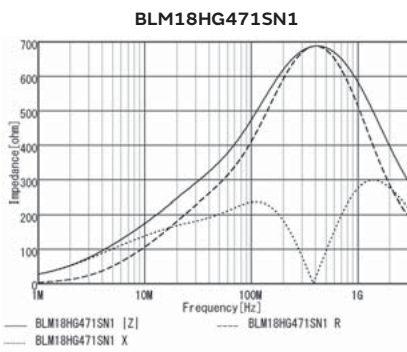
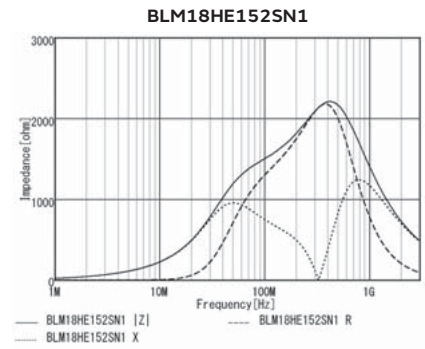
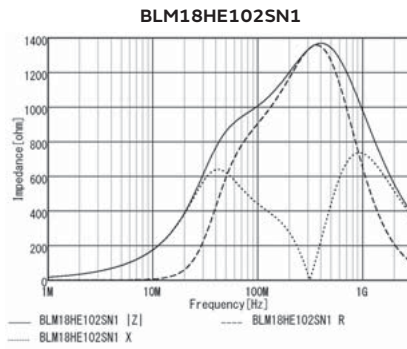
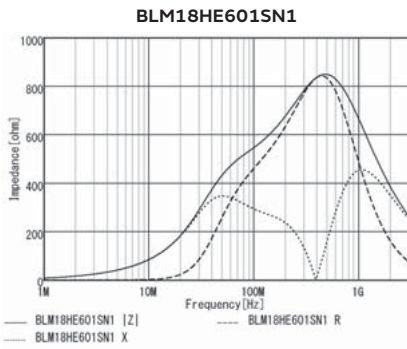
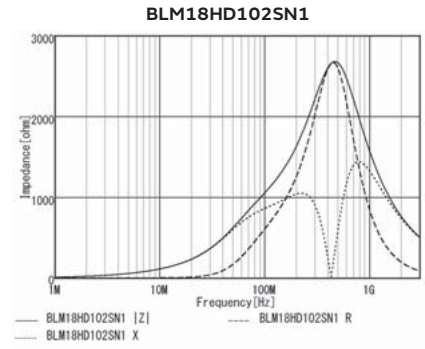
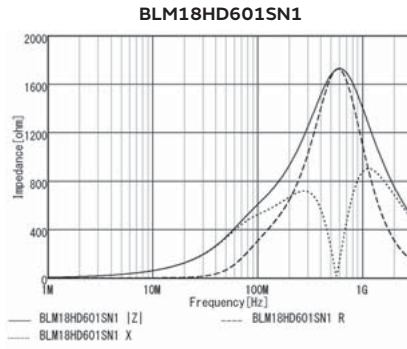
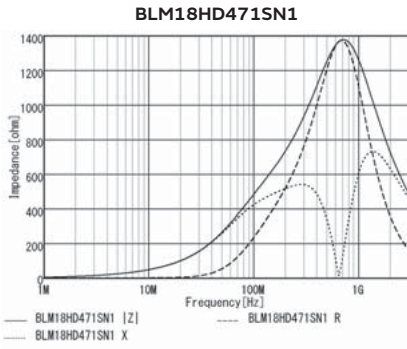

Chip Ferrite Bead

Application Specified Noise Filter

Chip EMIFIL®

Common Mode Choke Coil
 Common Mode Noise Filter

Block Type EMIFIL®

EMC Absorber

Continued from the preceding page. ↘

Derating of Rated Current

In operating temperature exceeding +85°C, derating of current is necessary for BLM18HE series.
Please apply the derating curve shown in chart according to the operating temperature.

Derating of Rated Current

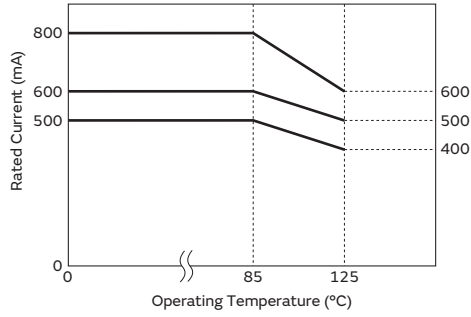

Chip Ferrite Bead (BLM18H Series) EMI Suppression Effect

Noise Suppression of BLM18H in UHF Range

Testing Circuit

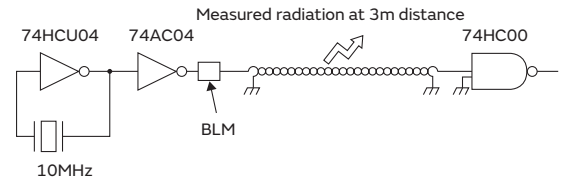

Type of Filter	EMI Suppression Effect / Description
Initial (No filter)	
Conventional Type BLM18AG102SN1 (1000Ω at 100MHz)	<p>Current BLM18AG are effective in suppressing noise in the range between 300MHz and 700MHz.</p>
for GHz Noise Suppression BLM18HG102SN1 (1000Ω at 100MHz)	<p>In addition to the effectiveness of current BLM, BLM18HG suppresses noise in the range beyond 700MHz.</p>

Comparison between BLM18HG102SN1 and BLM18AG102SN1 (Current Item)

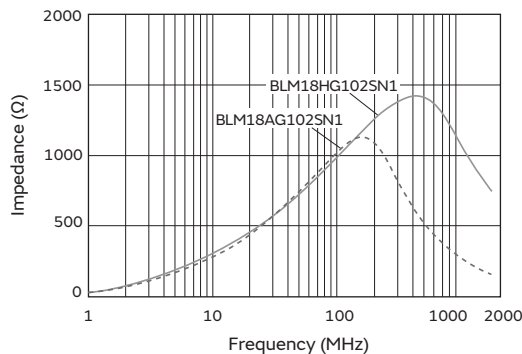

Chip ferrite bead

BLM18EG Series 0603/1608(inch/mm)

Appearance/Dimensions

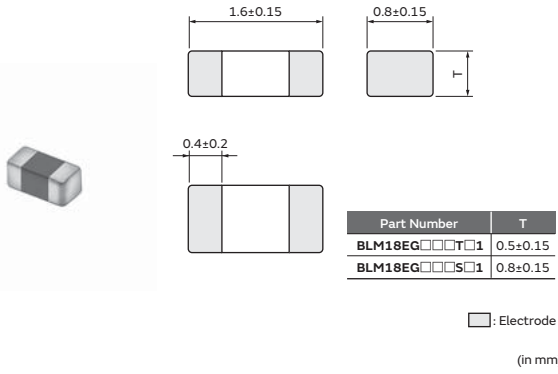

Packaging

Code	Packaging	Minimum Quantity
D	ø180mm Paper Tape	4000
J	ø330mm Paper Tape	10000
B	Bulk(Bag)	1000

Equivalent Circuit



(Resistance element becomes dominant at high frequencies.)

Rated Value (□: packaging code)

Part Number	Impedance at 100MHz	Impedance at 1GHz	Rated Current at 85°C	Rated Current at 125°C	DC Resistance
BLM18EG121SN1□	120Ω±25%	145Ω(Typ.)	2A	1A	0.04Ω
BLM18EG221SN1□	220Ω±25%	260Ω(Typ.)	2A	1A	0.05Ω
BLM18EG471SN1□	470Ω±25%	550Ω(Typ.)	500mA	500mA	0.21Ω
BLM18EG601SN1□	600Ω±25%	700Ω(Typ.)	500mA	500mA	0.35Ω
BLM18EG101TN1□	100Ω±25%	140Ω(Typ.)	2A	1A	0.045Ω
BLM18EG221TN1□	220Ω±25%	300Ω(Typ.)	1A	1A	0.15Ω
BLM18EG331TN1□	330Ω±25%	450Ω(Typ.)	500mA	500mA	0.21Ω
BLM18EG391TN1□	390Ω±25%	520Ω(Typ.)	500mA	500mA	0.3Ω

Operating Temp. Range: -55°C to 125°C

Z-f characteristics

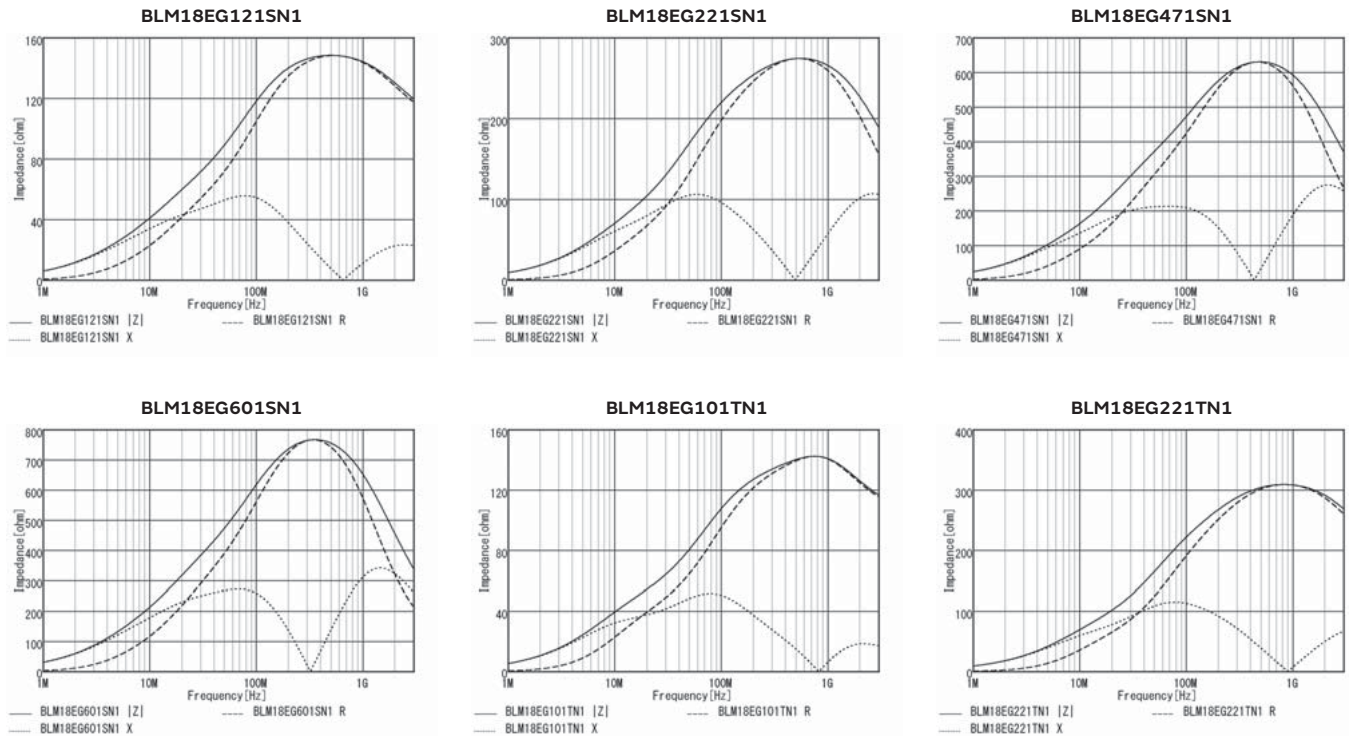

Continued on the following page. ↗

Continued from the preceding page. ↘

Z-f characteristics

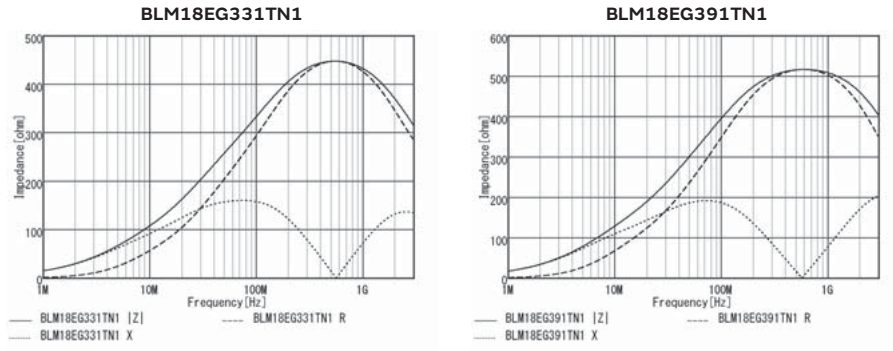

Derating of Rated Current

In operating temperature exceeding +85°C, derating of current is necessary for BLM18EG series.
 Please apply the derating curve shown in chart according to the operating temperature.

Derating of Rated Current

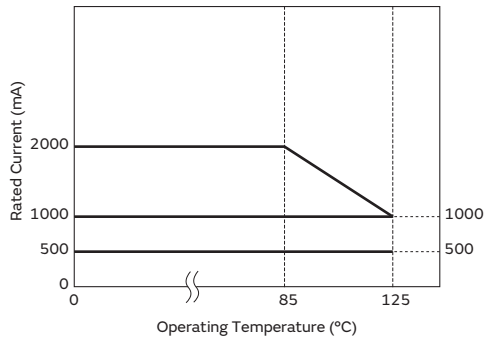

Chip ferrite bead

BLM18GG Series 0603/1608(inch/mm)

Appearance/Dimensions

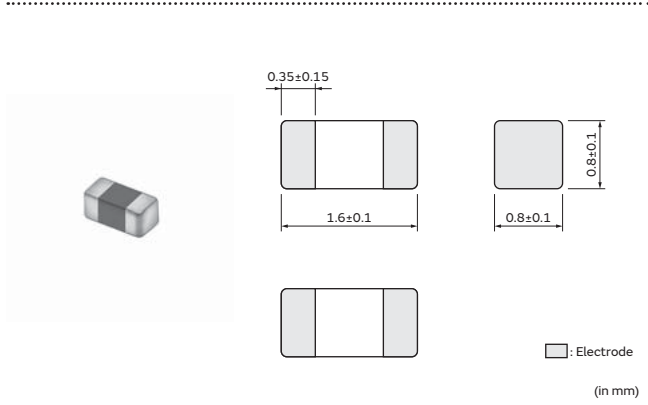

Packaging

Code	Packaging	Minimum Quantity
D	ø180mm Paper Tape	4000
J	ø330mm Paper Tape	10000
B	Bulk(Bag)	1000

Equivalent Circuit

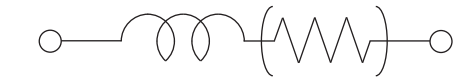

(Resistance element becomes dominant at high frequencies.)

Rated Value (□: packaging code)

Part Number	Impedance at 100MHz	Impedance at 1GHz	Rated Current at 85°C	Rated Current at 125°C	DC Resistance	Operating Temp. Range
BLM18GG471SN1□	470Ω±25%	1800Ω±30%	200mA	200mA	1.3Ω	-55°C to 125°C

Z-f characteristics

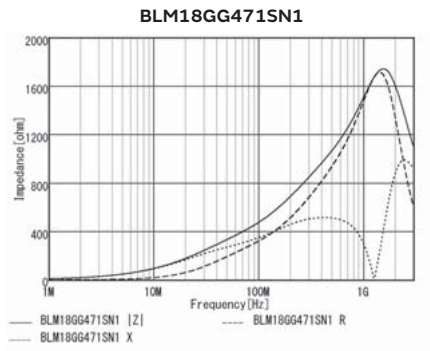

Chip Ferrite Bead (BLM/BLA/BLT) ⚠️Caution/Notice

⚠️Caution

Rating

1. About the Rated Current
 Do not use products beyond the rated current as this may create excessive heat and deteriorate the insulation resistance.
2. About Excessive Surge Current
 Surge current (pulse current or rush current) higher than

the specified rated current applied to the product may cause a critical failure, such as an open circuit or burnout caused by excessive temperature rise. Please contact us in advance in case of applying surge current.

Soldering and Mounting

- Self-heating
 Please pay special attention when mounting chip ferrite beads BLM_AX/P/K/S series BLT series in close proximity to other products that radiate heat.

The heat generated by other products may deteriorate the insulation resistance and cause excessive heat in this component.

Notice

Storage and Operating Conditions

<Operating Environment>

Do not use products in a corrodible atmosphere such as acidic gases, alkaline gases, chlorine, sulfur gases, organic gases (a sea breeze, Cl₂, H₂S, NH₃, SO₂, NO₂, etc.).
 Do not use products in an environment close to an organic solvent.

<Storage and Handling Requirements>

1. Storage Period
 BLM15E/15H/15G · BLT series should be used within 12

months; the other series should be used within 6 months. Solderability should be checked if this period is exceeded.

2. Storage Conditions

- (1) Storage temperature: -10 to +40°C
 Relative humidity: 15 to 85%
 Avoid sudden changes in temperature and humidity.
- (2) Do not store products in a chemical atmosphere such as chlorine gas, acid or sulfide gas.

Notice (Soldering and Mounting)

1. Cleaning
 Failure and degradation of a product can be caused by the cleaning method. When you clean in conditions that are not in the mounting information, please contact Murata engineering.
2. Soldering
 Reliability decreases with improper soldering methods. Please solder by the standard soldering conditions shown in the mounting information.

3. Other
 Noise suppression levels resulting from Murata's EMI suppression filters EMIFIL® may vary, depending on the circuits and ICs used, type of noise, mounting pattern, mounting location, and other operating conditions. Be sure to check and confirm in advance the noise suppression effect of each filter, in actual circuits, etc. before applying the filter in a commercial-purpose equipment design.

Handling

1. Resin Coating
 Using resin for coating/molding products may affect the product's performance.
 So please pay careful attention in selecting resin.
 Prior to use, please make a reliability evaluation with the product mounted in your application set.
2. Handling of Substrates
 After mounting products on a substrate, do not apply any stress to the product by bending or twisting the substrate

when cropping the substrate, inserting and removing a connector from the substrate or tightening a screw to the substrate.
 Excessive mechanical stress may cause cracking in the product.



Chip Ferrite Bead (BLM/BLA/BLT) Soldering and Mounting

1. Standard Land Pattern Dimensions

Land Pattern + Solder Resist
 Land Pattern
 Solder Resist
 (in mm)

Series

BLM02
BLM03
BLM15
BLM18
BLM21
BLM31
BLM41

●Reflow and Flow
 BLM Series

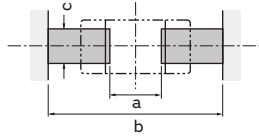

Type	Soldering	a	b	c
BLM02	Reflow	0.18	0.48	0.215
BLM03	Reflow	0.25	0.8	0.3
BLM15	Reflow	0.4	1.2	0.5
BLM18 (except 18G)	Flow	0.8	2.5	0.7
	Reflow	0.7	2.0	
BLM21	Flow	1.1	3.5	0.95
	Reflow	1.2	2.4	1.25

• Except for BLM02PX/BLM03AX · P□ · EB/15AX · KD · PD · PG · PX · EX/18PG · KG · SG · SN/21PG · S□. And BLM02/03/15/18G is specially adapted for reflow soldering.

BLM□□AX/P/K/S/E

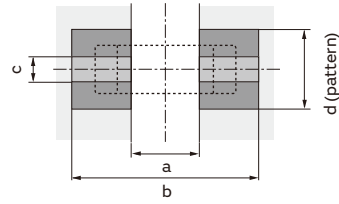

Type	Rated Current (A)	Soldering	a	b	c	Land Pad Thickness and Dimension d			
						18μm	35μm	70μm	
BLM02PX	1.1max.	Reflow	0.18	0.48	0.215	0.23	0.23	0.23	
BLM03AX	0.9max.	Reflow	0.25	0.8	0.3	0.3	0.3	0.3	
BLM03P□	1.8max.					1.2	0.7	0.3	
BLM03EB									
BLM15AX	1.5max.	Reflow	0.4	1.2	0.5	0.5	0.5	0.5	
BLM15KD						1.2	0.7	0.5	
BLM15PD	2.2max.					2.4	1.2	0.5	
BLM15PG	3.0max.	Reflow	0.4	1.2	0.5	2.4	1.2	0.5	
BLM15PX									
BLM15EX	1.3max.	Reflow	0.4	1.2	0.5	0.5	0.5	0.5	
	1.8max.					1.2	0.7	0.5	
BLM18PG	0.5-1.5	Flow/Reflow	Flow 0.8 Reflow 0.7	Flow 2.5 Reflow 2.0	Flow 0.7 Reflow 0.7	0.7	0.7	0.7	
						1.7-2.5	1.2	0.7	0.7
						3-4	2.4	1.2	0.7
BLM18SG	5-6	Flow/Reflow	Flow 0.8 Reflow 0.7	Flow 2.5 Reflow 2.0	Flow 0.7 Reflow 0.7	6.4	3.3	1.65	
BLM18SN	8					-	6.4	3.3	
BLM21PG	1.5	Flow/Reflow	Flow 1.1 Reflow 1.2	Flow 3.5 Reflow 2.4	Flow 0.95 Reflow 1.25	1.0	1.0	1.0	
	2					1.2	1.0	1.0	
	3-4					2.4	1.2	1.0	
	6					6.4	3.3	1.65	
BLM21S□	6-8.5	Flow/Reflow	Flow 1.1 Reflow 1.2	Flow 3.5 Reflow 2.4	Flow 0.95 Reflow 1.25	-	6.8	3.4	
BLM31PG	1.5-2	Flow/Reflow	Flow 2.4 Reflow 2	Flow 4.7 Reflow 4.3	Flow 1.2 Reflow 1.8	1.8	1.8	1.8	
	3.5					2.4	1.8	1.8	
	6					6.4	3.3	1.8	
BLM31KN	2	Reflow	Reflow 2	Reflow 4.3	Reflow 1.8	1.8	1.8	1.8	
	2.5-2.9					2.4	1.8	1.8	
	4-6					6.4	3.3	1.8	
BLM31SN	10-12	Flow/Reflow	Flow 2.4 Reflow 2	Flow 4.7 Reflow 4.3	Flow 1.2 Reflow 1.8	-	9.8	4.9	
BLM41PG	1.5-2	Flow/Reflow	3	6.0	1.2	1.2	1.2	1.2	
	3.5					2.4	1.2	1.2	
	6					6.4	3.3	1.65	

• Do not apply narrower pattern than listed above to BLM□□AX/P/K/S. Narrow pattern can cause excessive heat or open circuit.

BLA2A
BLA31

●Reflow Soldering
 BLA2A

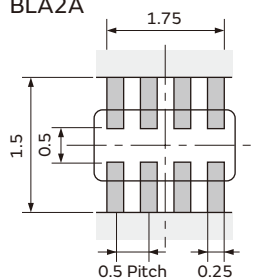

●Reflow and Flow
 BLA31

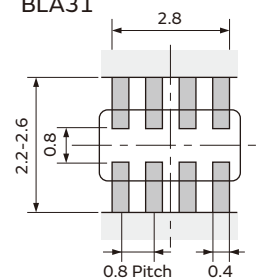

• If there are high amounts of self-heating on pattern, the contact points of PCB and part may become damaged.

Chip Ferrite Bead (BLM/BLA/BLT) Soldering and Mounting

Continued from the preceding page. ↘

(in mm)

Series	Standard Land Dimensions
BLT	<p>●Reflow Soldering</p> <div style="display: flex; justify-content: flex-end; margin-top: 10px;"> <div style="width: 15px; height: 10px; background-color: #ccc; border: 1px solid black; margin-right: 5px;"></div> Resist</div> <div style="width: 15px; height: 10px; background-color: #eee; border: 1px solid black; margin-right: 5px; margin-left: 5px;"></div> Copper foil pattern

● PCB Warping

PCB should be designed so that products are not subjected to mechanical stress caused by warping the board.

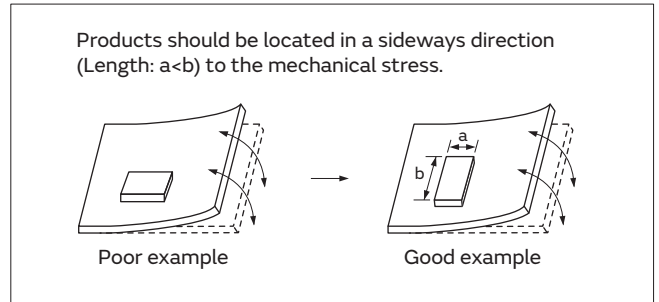

2. Solder Paste Printing and Adhesive Application

When reflow soldering the chip ferrite beads and bead inductors, the printing must be conducted in accordance with the following cream solder printing conditions. If too much solder is applied, the chip will be prone to damage by mechanical and thermal stress from the PCB and may crack. Standard land dimensions should be used for resist and copper foil patterns.

When flow soldering the chip ferrite beads and bead inductors, apply the adhesive in accordance with the following conditions. If too much adhesive is applied, it may overflow into the land or termination areas and yield poor solderability. In contrast, if insufficient adhesive is applied, or if the adhesive is not sufficiently hardened, then the chip may become detached during the flow soldering process.

(in mm)

Series	Solder Paste Printing	Adhesive Application
BLM	<p>●Ensure that solder is applied smoothly to a minimum height of 0.2mm to 0.3mm at the end surface of the part.</p> <p>●Guideline of solder paste thickness: 50-80μm: BLM02 100-150μm: BLM03 100-200μm: BLM15/18/21/31/41</p>	<p>BLM18/21/31/41 Series (except for BLM18G Series) Coating amount is illustrated in the following diagram.</p> <p>a: 20-70μm b: 30-35μm c: 50-105μm</p>
BLA	<p>●Guideline of solder paste thickness: 100-150μm: BLA2A 150-200μm: BLA31</p> <div style="display: flex; justify-content: space-around;"> <div style="text-align: center;"> <p>BLA31</p> </div> <div style="text-align: center;"> <p>BLA2A</p> </div> </div>	<p>BLA31 Series Coating amount is illustrated in the following diagram.</p> <p>a: 20-70μm b: 30-35μm c: 50-105μm</p>

Continued on the following page. ↗

Chip Ferrite Bead (BLM/BLA/BLT) Soldering and Mounting

Continued from the preceding page. ↘

(in mm)

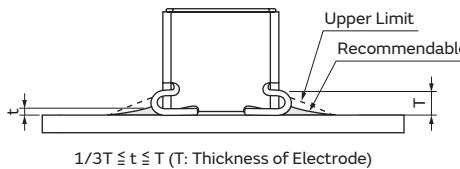
Series	Solder Paste Printing	Adhesive Application
BLT	<ul style="list-style-type: none"> ● Solder shall be used not to exceed the upper limits as shown below. ● Guideline of solder paste thickness: 150µm: BLT5B 	

3. Standard Soldering Conditions

(1) Soldering Methods

Use flow and reflow soldering methods only.
 Use standard soldering conditions when soldering chip ferrite beads and bead inductors.
 In cases where several different parts are soldered, each having different soldering conditions, use those conditions requiring the least heat and minimum time.

Solder: Use Sn-3.0Ag-0.5Cu solder. Use of Sn-Zn based solder will deteriorate performance of products.
 If using BLA series with Sn-Zn based solder, please contact Murata in advance.

Flux:

- Use rosin based flux.
 In case of using RA type solder, products should be cleaned completely with no residual flux.
- Do not use strong acidic flux (with chlorine content exceeding 0.20wt%)
- Do not use water-soluble flux.

For additional mounting methods, please contact Murata.

(2) Soldering Profile

- Flow Soldering Profile (Sn-3.0Ag-0.5Cu Solder)

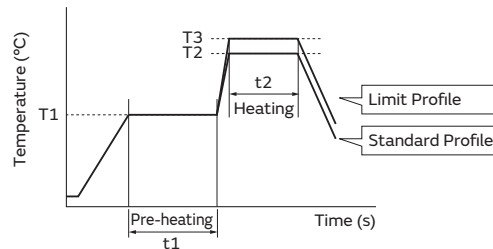

Series	Pre-heating		Standard Profile			Limit Profile		
	Temp. (T1)	Time (t1)	Heating		Cycle of Flow	Heating		Cycle of Flow
			Temp. (T2)	Time (t2)		Temp. (T3)	Time (t2)	
BLM (except for BLM02/03/15/18G) BLA31	150°C	60s min.	250°C	4 to 6s	2 times max.	265±3°C	5s max.	2 times max.

Continued on the following page. ↗

Chip Ferrite Bead (BLM/BLA/BLT) Soldering and Mounting

Continued from the preceding page. ↘

●Reflow Soldering Profile (Sn-3.0Ag-0.5Cu Solder)

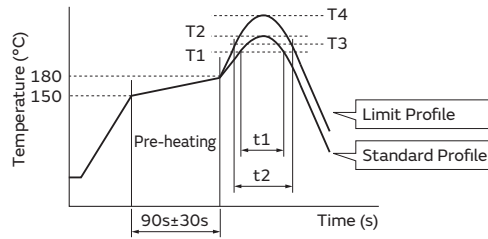

Series	Standard Profile				Limit Profile			
	Heating		Peak Temperature (T2)	Cycle of Reflow	Heating		Peak Temperature (T4)	Cycle of Reflow
	Temp. (T1)	Time (t1)			Temp. (T3)	Time (t2)		
BLM BLA	220°C min.	30 to 60s	245±3°C	2 times max.	230°C min.	60s max.	260°C/10s	2 times max.
BLT					240°C min.	30s max.		

(3) Reworking with a soldering Iron

The following conditions must be strictly followed when using a soldering iron (except for BLM02 Series).

Pre-heating: 150°C 60s min.

Soldering iron power output / Tip diameter:
 80W max. / ø3mm max.

Temperature of soldering iron tip / Soldering time / Times:

350°C max. / 3-4s / 2 times

Do not allow the tip of the soldering iron to directly contact the chip.

For additional methods of reworking with a soldering iron, please contact Murata engineering.

4. Cleaning

The following conditions should be observed when cleaning chip ferrite beads.

(1) Cleaning temperature: 60°C max. (40°C max. for alcohol type cleaner)

(2) Ultrasonic

Output: 20W/liter max.

Duration: 5 minutes max.

Frequency: 28 to 40kHz

(3) Cleaning Agent

The following cleaning agents have been tested on the individual components. Evaluation of final assembly should be completed prior to production.

Do not clean BLT series.

In case of cleaning, please contact Murata engineering.

(a) Alcohol cleaning agent

Isopropyl alcohol (IPA)

(b) Aqueous cleaning agent

Pine Alpha ST-100S

(4) Ensure that flux residue is completely removed.

The component should be thoroughly dried after the aqueous agent has been removed with deionized water.

(5) BLM_G type is processed with resin. On rinsing the product, using water for ultrasonic cleaning may affect the resin quality used for the product by water element. In case of set cleaning conditions, please make a reliability evaluation according to the cleaning conditions.

Chip Ferrite Bead (BLM/BLA/BLT) Packaging

Minimum Quantity and Dimensions of 8mm Width Paper / Embossed Tape

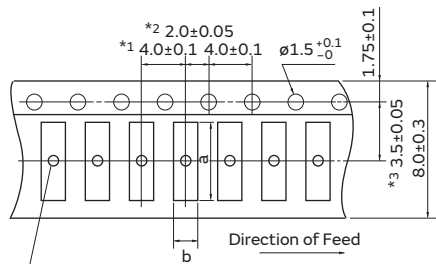

There are holes in the cavities of the BLM21BD222SN1/BD272SN1 and BLM31 only. $\phi 1.0 +0.3 -0$. BLE32 only. $\phi 1.0 +0.2 -0$.

- *1 BLM02/03/15: 2.0 ± 0.05
 BLA2A: 2.0 ± 0.1
 BLM18SG/TG: 2.0 ± 0.05
- *2 BLA2A/31: 2.0 ± 0.1
- *3 BLA2A/31: 3.5 ± 0.1

Dimension of the cavity of embossed tape is measured at the bottom side.

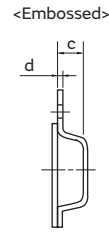

c: Depth of Cavity (Embossed Tape)

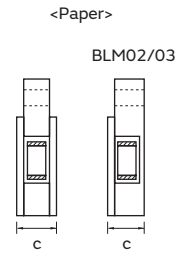

c: Total Thickness of Tape (Paper Tape)

Part Number	Dimensions				Minimum Qty. (pcs.)				Bulk
					ø180mm Reel		ø330mm Reel		
	a	b	c	d	Paper Tape	Embossed Tape	Paper Tape	Embossed Tape	
BLM02 (except for BLM02KX)	0.45	0.25	0.40 max.	-	20000	-	-	-	1000
BLM02KX	0.45	0.25	0.52 max.	-	15000	-	-	-	1000
BLM03	0.66	0.36	0.55 max.	-	15000	-	50000	-	1000
BLM15	1.15	0.65	0.8 max.	-	10000	-	50000	-	1000
BLM18A/B/P/R/H/G	1.85	1.05	1.1 max.	-	4000	-	10000	-	1000
BLM18EG/KG_TN	1.85	1.05	0.85 max.	-	4000	-	10000	-	1000
BLM18EG/KG_SN			1.1 max.						
BLM18SD	1.85	1.05	1.1 max.	-	10000	-	30000	-	1000
BLM18SG_SN1			0.85 max.						
BLM18SN			0.9 max.						
BLM18SG_TN1			0.9 max.						
BLM18T	1.85	1.05	0.90 max.	-	10000	-	-	-	1000
BLM21	2.25	1.45	1.1 max.	-	4000	-	10000	-	1000
BLM31 (except for BLM31KN)	3.5	1.9	1.3	0.2	-	3000	-	10000	1000
BLM31KN	3.5	1.9	1.75	0.2	-	2500	-	8000	1000
BLM21BD222SN1/272SN1	2.25	1.45	1.3	0.2	-	3000	-	10000	1000
BLA2A	2.2	1.2	0.8 max.	-	10000	-	50000	-	1000
BLA31	3.4	1.8	1.1 max.	-	4000	-	10000	-	1000

(in mm)

Continued on the following page. ↗

"Minimum Quantity" means the number of units of each delivery or order. The quantity should be an integral multiple of the "Minimum Quantity."

Chip Ferrite Bead (BLM/BLA/BLT) Packaging

Continued from the preceding page. ↘

Minimum Quantity and Dimensions of 12mm Width Embossed Tape

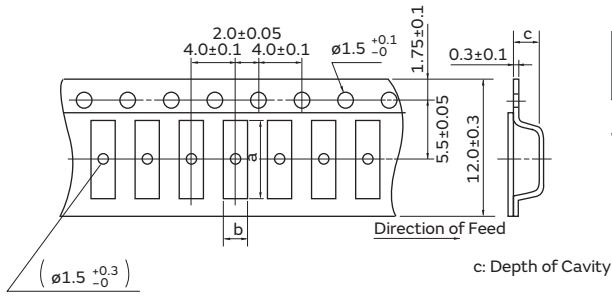

Dimension of the cavity is measured at the bottom side.

Part Number	Dimensions			Minimum Qty. (pcs.)		
	a	b	c	φ180mm Reel	φ330mm Reel	Bulk
BLM41	4.8	1.9	1.75	2500	8000	1000

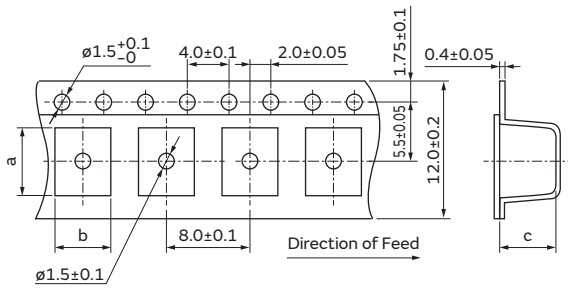

Dimension of the cavity is measured at the bottom side.

Part Number	Dimensions			Minimum Qty. (pcs.)		
	a	b	c	φ180mm Reel	φ330mm Reel	Bulk
BLT5B	6.5	5.35	0.4	300	-	50

(in mm)

"Minimum Quantity" means the number of units of each delivery or order. The quantity should be an integral multiple of the "Minimum Quantity."

Application Specified Noise Filter NFZ_S/NFZ_B/BLF/BLE/LQW_CA Series

Part Numbering	p118
Series Lineup	p122
Product Detail	
Noise filter for audio lines	p126
Noise filter for LED lighting equipment	p133
Frequency specified noise filter	p142
Noise filter for power charger lines	p145
Inductor for audio line noise suppression	p147
⚠Caution/Notice	p151
Soldering and Mounting	p154
Packaging	p160

● Part Numbering

Chip EMIFIL®

(Part Number)

NF	Z	32	BW	3R6	H	N	1	0	L
①	②	③	④	⑤	⑥	⑦	⑧	⑨	⑩

① Product ID

Product ID	
NF	Chip EMIFIL®

② Structure

Code	Structure
Z	Inductor Type

③ Dimensions (LxW)

Code	Dimensions (LxW)	Size Code (inch)
03	0.6x0.3mm	0201
15	1.0x0.5mm	0402
18	1.6x0.8mm	0603
2M	2.0x1.6mm	0806
2H	2.5x2.0mm	1008
32	3.2x2.5mm	1210
5B	5.0x5.0mm	2020

④ Features

Code	Features
SM	For Audio Lines Multilayer Type
SW	For Audio Lines Wire Wound Type
BW	For LED Lines Wire Wound Type
BM	For LED Lines Multilayer Type
SG	For Audio Lines Multilayer Type (For GHz Band Use)

⑤ Impedance

Expressed by three figures. The unit is in ohm (Ω). The first and second figures are significant digits, and the third figure expresses the number of zeros that follow the two figures.

⑥ Inductance Tolerance

Code	Features
S	For General Use (Sn Plating)
H	For General Use (LF Solder) *1
L	For General Use (LF Solder)

*1 NFZ32SW/32BW_H□1 only.

⑦ Category

Code	Category
N	For General-Purpose

⑧ Number of Circuits

Code	Number of Circuits
1	1 Circuit

⑨ Specification

Code	Specification
0	Standard Type
1	Low Rdc Type

⑩ Packaging

Code	Packaging
K	Embossed Taping (\varnothing 330mm Reel)
L	Embossed Taping (\varnothing 180mm Reel)
B	Bulk
D	Paper Taping (\varnothing 180mm Reel)

Frequency Specified Filters

(Part Number)

BLF	03	J	D	421	G	N	E	D
①	②	③	④	⑤	⑥	⑦	⑧	⑨

① Product ID

Code	
BLF	Frequency Specified Filters

② Dimensions (LxW)

Code	Dimensions (LxW)	Size Code (inch)
02	0.4×0.2mm	01005
03	0.6×0.3mm	0201

③ Target Frequency

Code	Target Frequency
J	700MHz
R	2.4GHz
V	5GHz

④ Characteristics Classification

⑤ Impedance at Target Frequency

Expressed by three figures. The unit is in ohm (Ω).
 The first and second figures are significant digits, and the third figure expresses the number of zeros that follow the two figures.

⑥ Chip Shape/Electrode

Expressed by a letter.

Code	Chip Shape/Electrode
G	High Profile (Sn Plating/5 Surface Electrode)
S	Standard (Sn Plating/5 Surface Electrode)

⑦ Category

Code	Category
N	For General-Purpose

⑧ Rated Current

Code	Rated Current
E	500mA max.
G	1A max.
L	2A max.

⑨ Packaging

Code	Packaging
E	Embossed Taping (\varnothing 180mm Reel*1)
B	Bulk
D	Paper Taping (\varnothing 180mm Reel)

*1 Width 8mm

Chip Power Bead

(Part Number)

BLE	18	PS	080	S	N	1	D
①	②	③	④	⑤	⑥	⑦	⑧

① Product ID

Product ID	
BLE	Chip Ferrite Beads

② Dimensions (LxW)

Code	Dimensions (LxW)	Size Code (inch)
18	1.6x0.8mm	0603
32	3.2x2.5mm	1210

③ Characteristics/Applications

Code ^{*1}	Characteristics/Applications
PN	For Power Lines
PS	

^{*1} Frequency characteristics vary with each code.

④ Impedance

Expressed by three figures. The unit is in ohm (Ω) at 100MHz. The first and second figures are significant digits, and the third figure expresses the number of zeros that follow the two figures.

⑤ Electrode

Expressed by a letter.

Ex.)

Code	Electrode
S	Sn Plating

⑥ Category

Code	Category
N	For General-Purpose

⑦ Number of Circuits

Code	Number of Circuits
1	1 Circuit

⑧ Packaging

Code	Packaging
K	Embossed Taping (\varnothing 330mm Reel)
L	Embossed Taping (\varnothing 180mm Reel)
B	Bulk
J	Paper Taping (\varnothing 330mm Reel)
D	Paper Taping (\varnothing 180mm Reel)

Inductors for General Circuits

(Part Number)

LQ	W	04	C	A	R45	K	0	0	D
①	②	③	④	⑤	⑥	⑦	⑧	⑨	⑩

① Product ID

Product ID	
LQ	Chip Inductors (Chip Coils)

② Structure

Code	Structure
W	Wire Wound Type (Ferrite Core)

② Dimensions (LxW)

Code	Nominal Dimensions (LxW)	Size Code (in inch)
04	0.8x0.4mm	03019
15	1.0x0.5mm	0402
18	1.6x0.8mm	0603

④ Applications and Characteristics

Code	Series	Applications and Characteristics
C	LQW	for Choke

⑤ Category

Code	Category	
A	General	Impedance Device (Near GHz Band)

⑥ Inductance

Expressed by three-digit alphanumerics. The unit is micro-henry (μH). The first and second figures are significant digits, and the third figure expresses the number of zeros that follow the two figures. If there is a decimal point, it is expressed by the capital letter "R." In this case, all figures are significant digits. If inductance is less than $0.1\mu\text{H}$, the inductance code is expressed by a combination of two figures and the capital letter "N," and the unit of inductance is nano-henry (nH). The capital letter "N" indicates the unit of "nH," and also expresses a decimal point. In this case, all figures are significant digits.

⑦ Inductance Tolerance

Code	Inductance Tolerance
J	$\pm 5\%$
K	$\pm 10\%$

⑧ Features

Code	Features	Series
0	Standard Type	LQW

⑨ Electrode

•Lead (Pb) Free

Code	Electrode	Series
0	Sn	LQW

⑩ Packaging

Code	Packaging
B	Bulk
J	Paper Taping ($\phi 330\text{mm}$ Reel)
D	Paper Taping ($\phi 180\text{mm}$ Reel)

Series Lineup

NFZ_S

Noise filter for audio lines

Size Code in inches (mm)	Thickness (mm)	Part Number	Impedance				Rated Current
			at 1MHz	at 100MHz	at 900MHz	at 1.7GHz	
0201 (0603)	0.3	NFZ03SG331SN10 ^{p126}	-	-	330Ω (Typ.)	400Ω (Typ.)	305mA
	0.3	NFZ03SG501SN10 ^{p126}	-	-	500Ω (Typ.)	600Ω (Typ.)	275mA
	0.3	NFZ03SG671SN10 ^{p126}	-	-	670Ω (Typ.)	800Ω (Typ.)	250mA
	0.3	NFZ03SG102SN10 ^{p126}	-	-	1000Ω (Typ.)	900Ω (Typ.)	210mA
	0.3	NFZ03SG162SN10 ^{p126}	-	-	1600Ω (Typ.)	1200Ω (Typ.)	180mA
0402 (1005)	0.5	NFZ15SG771SN10 ^{p127}	-	-	770Ω (Typ.)	900Ω (Typ.)	500mA
	0.5	NFZ15SG152SN10 ^{p127}	-	-	1500Ω (Typ.)	1200Ω (Typ.)	400mA
	0.5	NFZ15SG262SN10 ^{p127}	-	-	2600Ω (Typ.)	1450Ω (Typ.)	350mA
	0.5	NFZ15SG462SN10 ^{p127}	-	-	4600Ω (Typ.)	1800Ω (Typ.)	270mA
	0.5	NFZ15SG101SN11 ^{p127}	-	-	100Ω (Typ.)	160Ω (Typ.)	1.1A
	0.5	NFZ15SG151SN11 ^{p127}	-	-	150Ω (Typ.)	250Ω (Typ.)	1A
	0.5	NFZ15SG331SN11 ^{p127}	-	-	330Ω (Typ.)	540Ω (Typ.)	650mA
0603 (1608)	0.8	NFZ18SM121SN10 ^{p129}	-	120Ω±25%	-	-	1.25A
	0.8	NFZ18SM251SN10 ^{p129}	-	250Ω±25%	-	-	1.1A
	0.8	NFZ18SM501SN10 ^{p129}	-	500Ω±25%	-	-	950mA
	0.8	NFZ18SM701SN10 ^{p129}	-	700Ω±25%	-	-	800mA
0806 (2016)	0.9	NFZ2MSM101SN10 ^{p131}	-	100Ω±25%	-	-	4A
	0.9	NFZ2MSM181SN10 ^{p131}	-	180Ω±25%	-	-	3.4A
	0.9	NFZ2MSM301SN10 ^{p131}	-	300Ω±25%	-	-	3.1A
	0.9	NFZ2MSM601SN10 ^{p131}	-	600Ω±25%	-	-	2.5A
1210 (3225)	1.55	NFZ32SW301HN10 ^{p132}	3.2Ω±30%	300Ω (Typ.)	-	-	2.55A
	1.55	NFZ32SW901HN10 ^{p132}	6.8Ω±30%	900Ω (Typ.)	-	-	2.05A

NFZ_B

Noise filter for LED lighting equipment

Size Code in inches (mm)	Thickness (mm)	Part Number	Impedance (at 1MHz)	Rated Current
1008 (2520)	0.9	NFZ2HBM1R5SN10 ^{p133}	1.5Ω±30%	1.2A
	0.9	NFZ2HBM2R9SN10 ^{p133}	2.9Ω±30%	1.1A
	0.9	NFZ2HBM4R4SN10 ^{p133}	4.4Ω±30%	1.05A
	0.9	NFZ2HBM6R1SN10 ^{p133}	6.1Ω±30%	1A
	0.9	NFZ2HBM8R4SN10 ^{p133}	8.4Ω±30%	900mA
	0.9	NFZ2HBM110SN10 ^{p133}	11Ω±30%	800mA
	0.9	NFZ2HBM170SN10 ^{p133}	17Ω±30%	700mA
	0.9	NFZ2HBM240SN10 ^{p133}	24Ω±30%	650mA
	0.9	NFZ2HBM330SN10 ^{p133}	33Ω±30%	500mA
	0.9	NFZ2HBM600SN10 ^{p133}	60Ω±30%	400mA
1210 (3225)	1.55	NFZ32BW3R6HN10 ^{p135}	3.6Ω±30%	2.55A
	1.55	NFZ32BW7R4HN10 ^{p135}	7.4Ω±30%	2.05A
	1.55	NFZ32BW9R0HN10 ^{p135}	9Ω±30%	1.75A
	1.55	NFZ32BW150HN10 ^{p135}	15Ω±30%	1.6A
	1.55	NFZ32BW210HN10 ^{p135}	21Ω±30%	1.2A
	1.55	NFZ32BW320HN10 ^{p135}	32Ω±30%	1A
	1.55	NFZ32BW420HN10 ^{p135}	42Ω±30%	850mA
	1.55	NFZ32BW700HN10 ^{p135}	70Ω±30%	700mA
	1.55	NFZ32BW111HN10 ^{p135}	110Ω±30%	520mA
	1.55	NFZ32BW151HN10 ^{p135}	150Ω±30%	450mA
	1.55	NFZ32BW221HN10 ^{p135}	220Ω±30%	390mA
	1.55	NFZ32BW291HN10 ^{p135}	290Ω±30%	310mA

Continued on the following page. ↗

Size Code in inches (mm)	Thickness (mm)	Part Number	Impedance (at 1MHz)	Rated Current
1210 (3225)	1.55	NFZ32BW451HN10 ^{p135}	450Ω±30%	275mA
	1.55	NFZ32BW621HN10 ^{p135}	620Ω±30%	250mA
	1.55	NFZ32BW881HN10 ^{p135}	880Ω±30%	200mA
	1.55	NFZ32BW3R3HN11 ^{p135}	3.3Ω±30%	2.9A
	1.55	NFZ32BW6R8HN11 ^{p135}	6.8Ω±30%	2.5A
	1.55	NFZ32BW8R4HN11 ^{p135}	8.4Ω±30%	2.4A
	1.55	NFZ32BW9R8HN11 ^{p135}	9.8Ω±30%	2.1A
	1.55	NFZ32BW120HN11 ^{p136}	12Ω±30%	1.85A
	1.55	NFZ32BW190HN11 ^{p136}	19Ω±30%	1.8A
	1.55	NFZ32BW210HN11 ^{p136}	21Ω±30%	1.55A
	1.55	NFZ32BW310HN11 ^{p136}	31Ω±30%	1.2A
	1.55	NFZ32BW520HN11 ^{p136}	52Ω±30%	1.1A
	1.55	NFZ32BW650HN11 ^{p136}	65Ω±30%	900mA
	1.55	NFZ32BW101HN11 ^{p136}	100Ω±30%	900mA
1.55	NFZ32BW151HN11 ^{p136}	150Ω±30%	700mA	
2020 (5050)	2.0	NFZ5BBW2R9LN10 ^{p139}	2.9Ω±30%	4A
	2.0	NFZ5BBW4R5LN10 ^{p139}	4.5Ω±30%	3.4A
	2.0	NFZ5BBW6R7LN10 ^{p139}	6.7Ω±30%	3.1A
	2.0	NFZ5BBW7R6LN10 ^{p139}	7.6Ω±30%	3.1A
	2.0	NFZ5BBW100LN10 ^{p139}	10Ω±30%	3A
	2.0	NFZ5BBW140LN10 ^{p139}	14Ω±30%	2.6A
	2.0	NFZ5BBW170LN10 ^{p139}	17Ω±30%	2.5A
	2.0	NFZ5BBW220LN10 ^{p139}	22Ω±30%	2.3A
	2.0	NFZ5BBW310LN10 ^{p139}	31Ω±30%	2A
	2.0	NFZ5BBW450LN10 ^{p139}	45Ω±30%	1.65A
	2.0	NFZ5BBW520LN10 ^{p139}	52Ω±30%	1.61A
	2.0	NFZ5BBW610LN10 ^{p139}	61Ω±30%	1.6A
	2.0	NFZ5BBW970LN10 ^{p139}	97Ω±30%	1.2A
	2.0	NFZ5BBW141LN10 ^{p139}	140Ω±30%	1.05A

BLF

Frequency specified noise filter

Size Code in inches (mm)	Thickness (mm)	Part Number	Target Frequency	Impedance	Rated Current
01005 (0402)	0.3	BLF02JD361GNE ^{p142}	700MHz	360Ω±40%	380mA
	0.3	BLF02JD471GNE ^{p142}	700MHz	470Ω±40%	330mA
	0.3	BLF02RD331GNE ^{p143}	2.4GHz	330Ω±40%	330mA
	0.3	BLF02RD471GNE ^{p143}	2.4GHz	470Ω±40%	200mA
0201 (0603)	0.4	BLF03JD421GNE ^{p144}	700MHz	420Ω±40%	480mA

BLE

Noise filter for power charger lines

Size Code in inches (mm)	Thickness (mm)	Part Number	Impedance (at 100MHz)	Rated Current
0603 (1608)	0.6	BLE18PS080SN1 ^{p145}	8.5Ω±25%	8A
1210 (3225)	1.5	BLE32PN260SN1 ^{p146}	26Ω±10Ω	10A
	2.0	BLE32PN300SN1 ^{p146}	30Ω±10Ω	10A

LQW_CA

Inductor for audio line noise suppression

Size Code in inches (mm)	Thickness (mm)	Part Number	Inductance	Rated Current	Max. of DC Resistance	S.R.F.* (min.)
03019 (0805)	0.5	LQW04CA60NK00 ^{p147}	60nH±10%	620mA	0.18Ω	3000MHz
	0.5	LQW04CA90NK00 ^{p147}	90nH±10%	520mA	0.24Ω	2500MHz
	0.5	LQW04CAR12K00 ^{p147}	120nH±10%	510mA	0.28Ω	2100MHz
	0.5	LQW04CAR29K00 ^{p147}	290nH±10%	270mA	0.94Ω	1400MHz
	0.5	LQW04CAR45K00 ^{p147}	450nH±10%	200mA	1.23Ω	850MHz
	0.5	LQW04CAR51K00 ^{p147}	510nH±10%	200mA	1.31Ω	700MHz
0402 (1005)	0.56	LQW15CA22NJ00 ^{p148}	22nH±5%	1300mA	0.06Ω	3000MHz
	0.56	LQW15CA22NK00 ^{p148}	22nH±10%	1300mA	0.06Ω	3000MHz
	0.56	LQW15CA39NJ00 ^{p148}	39nH±5%	1100mA	0.075Ω	2700MHz
	0.56	LQW15CA39NK00 ^{p148}	39nH±10%	1100mA	0.075Ω	2700MHz
	0.56	LQW15CA59NJ00 ^{p148}	59nH±5%	1000mA	0.095Ω	2300MHz
	0.56	LQW15CA59NK00 ^{p148}	59nH±10%	1000mA	0.095Ω	2300MHz
	0.56	LQW15CA83NJ00 ^{p148}	83nH±5%	970mA	0.12Ω	1700MHz
	0.56	LQW15CA83NK00 ^{p148}	83nH±10%	970mA	0.12Ω	1700MHz
	0.56	LQW15CAR11J00 ^{p148}	110nH±5%	900mA	0.13Ω	1600MHz
	0.56	LQW15CAR11K00 ^{p148}	110nH±10%	900mA	0.13Ω	1600MHz
	0.56	LQW15CAR14J00 ^{p148}	140nH±5%	680mA	0.18Ω	1400MHz
	0.56	LQW15CAR14K00 ^{p148}	140nH±10%	680mA	0.18Ω	1400MHz
	0.56	LQW15CAR18J00 ^{p148}	180nH±5%	640mA	0.21Ω	1300MHz
	0.56	LQW15CAR18K00 ^{p148}	180nH±10%	640mA	0.21Ω	1300MHz
	0.56	LQW15CAR22J00 ^{p148}	220nH±5%	540mA	0.29Ω	1300MHz
	0.56	LQW15CAR22K00 ^{p148}	220nH±10%	540mA	0.29Ω	1300MHz
	0.56	LQW15CAR27J00 ^{p148}	270nH±5%	480mA	0.38Ω	1200MHz
	0.56	LQW15CAR27K00 ^{p149}	270nH±10%	480mA	0.38Ω	1200MHz
	0.56	LQW15CAR32J00 ^{p149}	320nH±5%	420mA	0.41Ω	1100MHz
	0.56	LQW15CAR32K00 ^{p149}	320nH±10%	420mA	0.41Ω	1100MHz
	0.56	LQW15CAR37J00 ^{p149}	370nH±5%	360mA	0.575Ω	1000MHz
	0.56	LQW15CAR37K00 ^{p149}	370nH±10%	360mA	0.575Ω	1000MHz
	0.56	LQW15CAR39J00 ^{p149}	390nH±5%	320mA	0.72Ω	950MHz
	0.56	LQW15CAR39K00 ^{p149}	390nH±10%	320mA	0.72Ω	950MHz
	0.56	LQW15CAR43J00 ^{p149}	430nH±5%	360mA	0.68Ω	920MHz
	0.56	LQW15CAR43K00 ^{p149}	430nH±10%	360mA	0.68Ω	920MHz
	0.56	LQW15CAR50J00 ^{p149}	500nH±5%	270mA	0.97Ω	900MHz
	0.56	LQW15CAR50K00 ^{p149}	500nH±10%	270mA	0.97Ω	900MHz
	0.56	LQW15CAR56J00 ^{p149}	560nH±5%	270mA	1.00Ω	900MHz
	0.56	LQW15CAR56K00 ^{p149}	560nH±10%	270mA	1.00Ω	900MHz
	0.56	LQW15CAR64J00 ^{p149}	640nH±5%	240mA	1.40Ω	870MHz
	0.56	LQW15CAR64K00 ^{p149}	640nH±10%	240mA	1.40Ω	870MHz
0.56	LQW15CAR73J00 ^{p149}	730nH±5%	200mA	1.95Ω	810MHz	
0.56	LQW15CAR73K00 ^{p149}	730nH±10%	200mA	1.95Ω	810MHz	
0.56	LQW15CAR80J00 ^{p149}	800nH±5%	190mA	2.10Ω	770MHz	
0.56	LQW15CAR80K00 ^{p149}	800nH±10%	190mA	2.10Ω	770MHz	
0.56	LQW15CA1R0K00 ^{p149}	1000nH±10%	180mA	2.20Ω	400MHz	
0.56	LQW15CA2R0K00 ^{p149}	2000nH±10%	130mA	3.20Ω	120MHz	
0603 (1608)	0.8	LQW18CA32NJ00 ^{p150}	32nH±5%	2200mA	0.030Ω	3000MHz
	0.8	LQW18CA56NJ00 ^{p150}	56nH±5%	1850mA	0.040Ω	2200MHz
	0.8	LQW18CA85NJ00 ^{p150}	85nH±5%	1650mA	0.048Ω	1800MHz
	0.8	LQW18CAR12J00 ^{p150}	120nH±5%	1500mA	0.058Ω	1500MHz
	0.8	LQW18CAR16J00 ^{p150}	160nH±5%	1300mA	0.075Ω	1350MHz
	0.8	LQW18CAR21J00 ^{p150}	210nH±5%	1050mA	0.115Ω	1150MHz
	0.8	LQW18CAR27J00 ^{p150}	270nH±5%	900mA	0.150Ω	1050MHz

*S.R.F.: Self-Resonant Frequency

Continued on the following page. ↗

Size Code in inches (mm)	Thickness (mm)	Part Number	Inductance	Rated Current	Max. of DC Resistance	S.R.F.* (min.)
0603 (1608)	0.8	LQW18CAR33J00 p150	330nH±5%	780mA	0.200Ω	970MHz
	0.8	LQW18CAR40J00 p150	400nH±5%	680mA	0.260Ω	900MHz
	0.8	LQW18CAR48J00 p150	480nH±5%	580mA	0.350Ω	800MHz
	0.8	LQW18CAR58J00 p150	580nH±5%	450mA	0.460Ω	760MHz

*S.R.F.: Self-Resonant Frequency

Application specified noise filter

NFZ03SG Series 0201/0603(inch/mm)

Noise filter for audio lines

Appearance/Dimensions

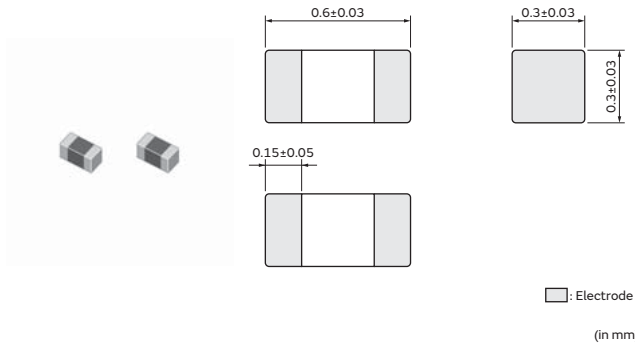

Packaging

Code	Packaging	Minimum Quantity
D	ø180mm Paper Tape	15000
B	Bulk(Bag)	1000

Equivalent Circuit



(Resistance element becomes dominant at high frequencies.)

Rated Value (□: packaging code)

Part Number	Impedance at 900MHz	Impedance at 1.7GHz	Rated Current	DC Resistance	DC Resistance (Max.)
NFZ03SG331SN10□	330Ω(Typ.)	400Ω(Typ.)	305mA	0.46Ω (Typ.)	0.6Ω
NFZ03SG501SN10□	500Ω(Typ.)	600Ω(Typ.)	275mA	0.56Ω (Typ.)	0.73Ω
NFZ03SG671SN10□	670Ω(Typ.)	800Ω(Typ.)	250mA	0.69Ω (Typ.)	0.88Ω
NFZ03SG102SN10□	1000Ω(Typ.)	900Ω(Typ.)	210mA	1Ω (Typ.)	1.3Ω
NFZ03SG162SN10□	1600Ω(Typ.)	1200Ω(Typ.)	180mA	1.3Ω (Typ.)	1.7Ω

Operating Temp. Range: -55°C to 125°C

Z-f characteristics

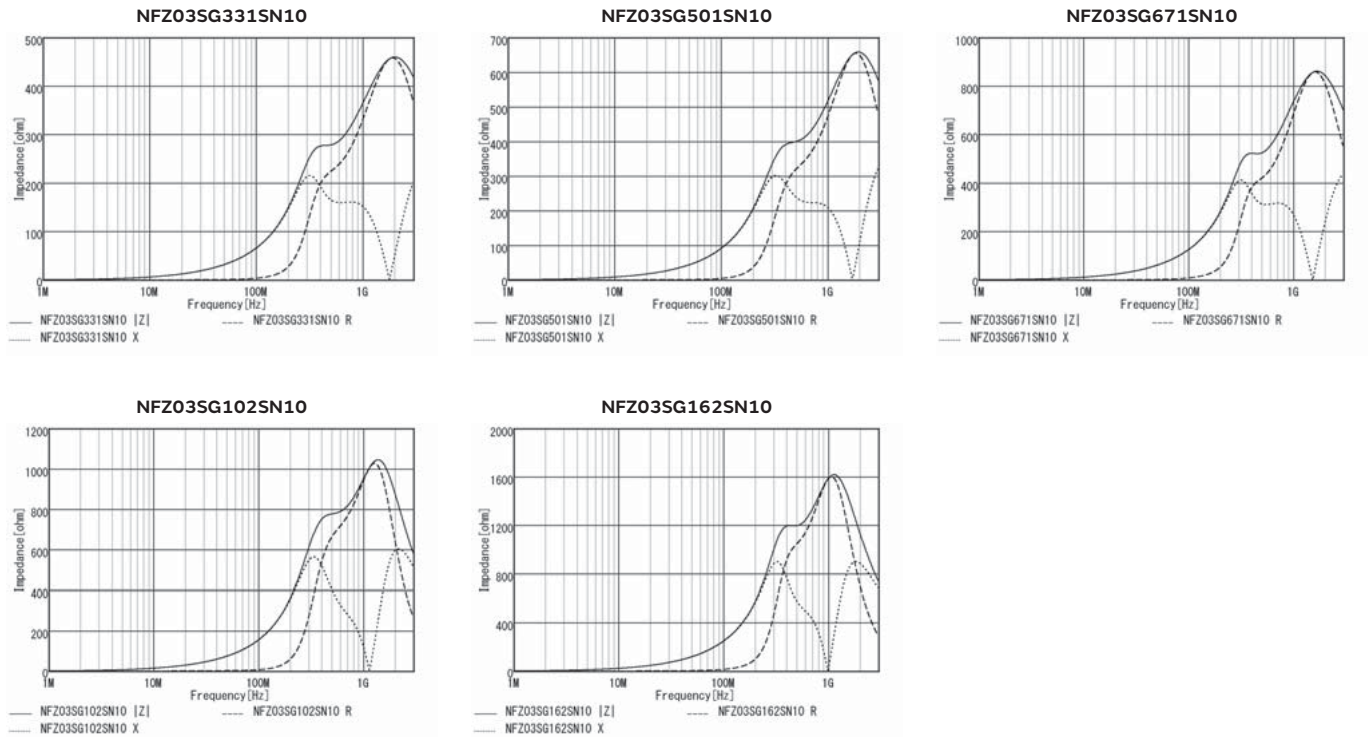

Application specified noise filter

NFZ15SG Series 0402/1005(inch/mm)

Noise filter for audio lines

Appearance/Dimensions

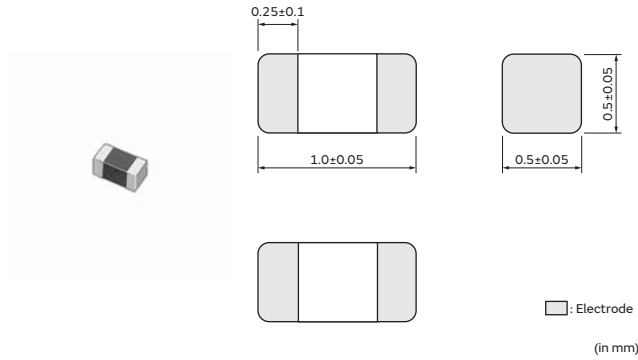

Packaging

Code	Packaging	Minimum Quantity
D	ø180mm Paper Tape	10000
B	Bulk(Bag)	1000

Equivalent Circuit

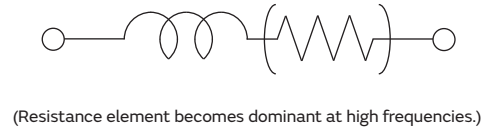

Rated Value (□: packaging code)

Part Number	Impedance at 900MHz	Impedance at 1.7GHz	Rated Current	DC Resistance	DC Resistance (Max.)
NFZ15SG771SN10□	770Ω(Typ.)	900Ω(Typ.)	500mA	0.35Ω (Typ.)	0.5Ω
NFZ15SG152SN10□	1500Ω(Typ.)	1200Ω(Typ.)	400mA	0.55Ω (Typ.)	0.8Ω
NFZ15SG262SN10□	2600Ω(Typ.)	1450Ω(Typ.)	350mA	0.80Ω (Typ.)	1Ω
NFZ15SG462SN10□	4600Ω(Typ.)	1800Ω(Typ.)	270mA	1.25Ω (Typ.)	1.65Ω
NFZ15SG101SN11□	100Ω(Typ.)	160Ω(Typ.)	1.1A	0.07Ω (Typ.)	0.1Ω
NFZ15SG151SN11□	150Ω(Typ.)	250Ω(Typ.)	1A	0.09Ω (Typ.)	0.12Ω
NFZ15SG331SN11□	330Ω(Typ.)	540Ω(Typ.)	650mA	0.20Ω (Typ.)	0.3Ω

Operating Temp. Range: -40°C to 85°C

Z-f characteristics

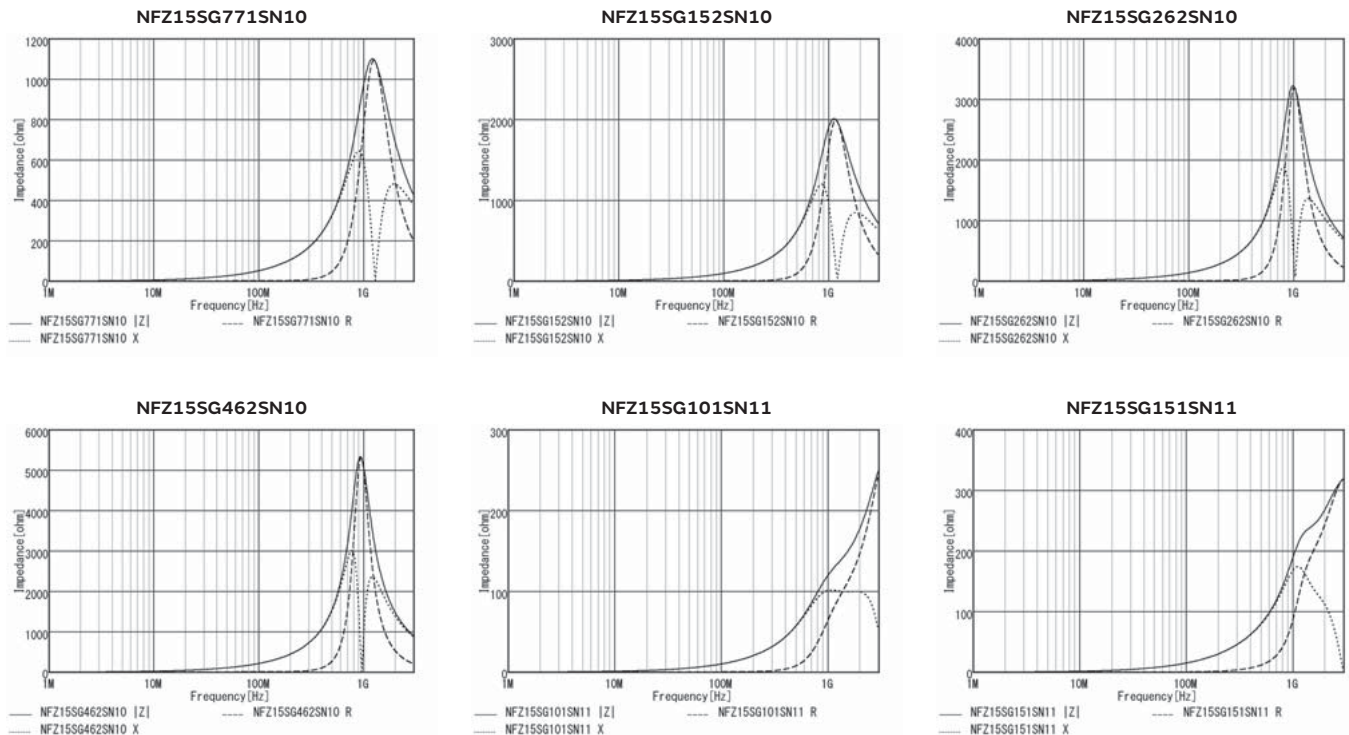

Continued on the following page. ↗

Continued from the preceding page. ↘

Z-f characteristics

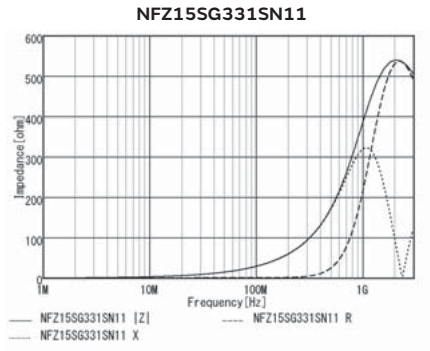

Application specified noise filter

NFZ18SM Series 0603/1608(inch/mm)

Noise filter for audio lines

Appearance/Dimensions

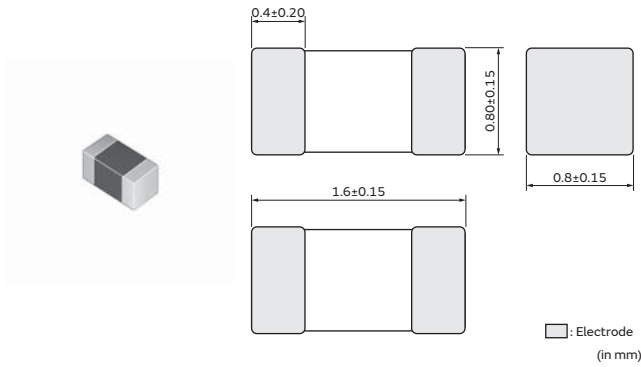

Packaging

Code	Packaging	Minimum Quantity
D	ø180mm Paper Tape	4000
B	Bulk(Bag)	1000

Equivalent Circuit

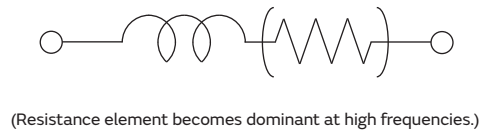

Rated Value (□: packaging code)

Part Number	Impedance at 100MHz	Rated Current	DC Resistance	DC Resistance (Max.)
NFZ18SM121SN10□	120Ω±25%	1.25A	0.11Ω (Typ.)	0.14Ω
NFZ18SM251SN10□	250Ω±25%	1.1A	0.15Ω (Typ.)	0.19Ω
NFZ18SM501SN10□	500Ω±25%	950mA	0.20Ω (Typ.)	0.25Ω
NFZ18SM701SN10□	700Ω±25%	800mA	0.23Ω (Typ.)	0.29Ω

Operating Temp. Range: -55°C to 125°C

Z-f characteristics

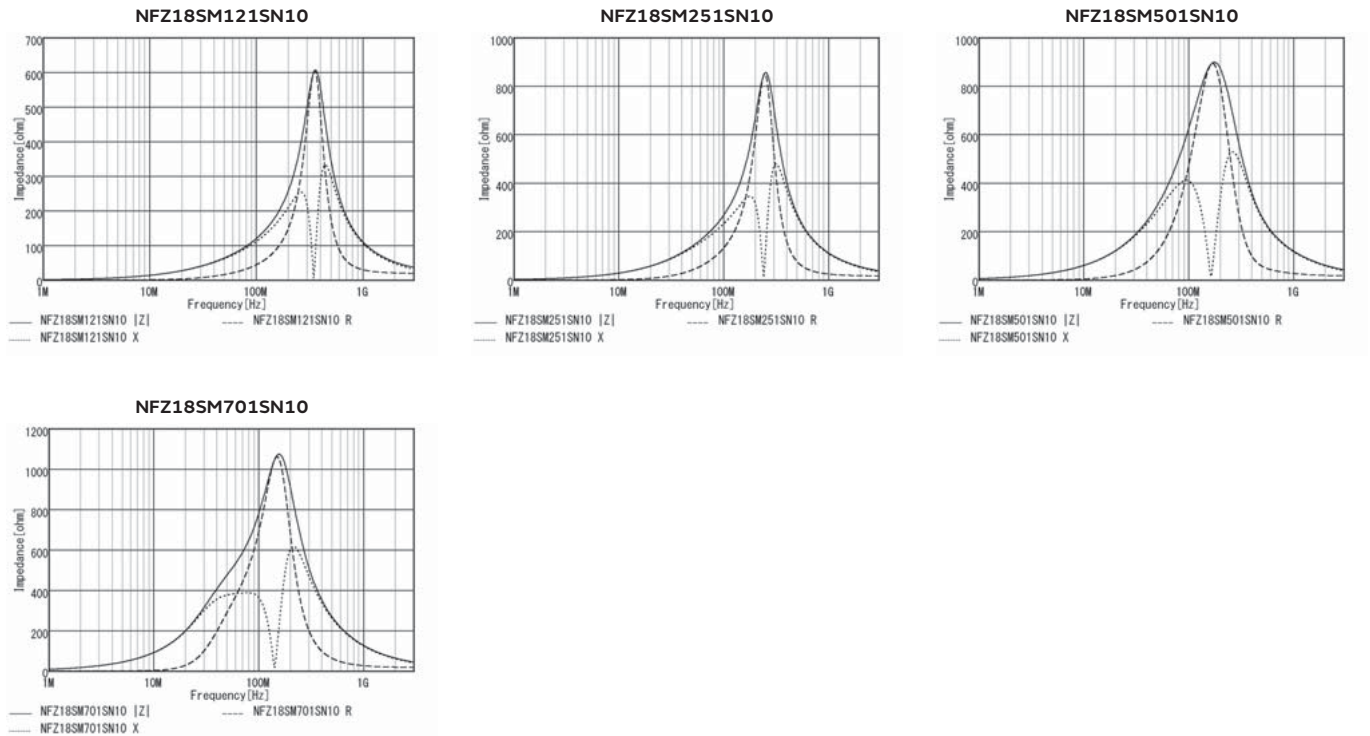

Continued on the following page. ↗

Continued from the preceding page. ↘

Derating of Rated Current

In operating temperature exceeding +85°C, derating of current is necessary for NFZ18SM series.
Please apply the derating curve shown in chart according to the operating temperature.

Derating of Rated Current

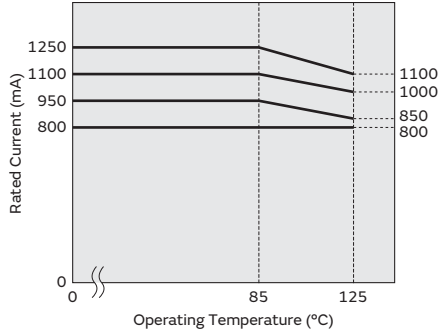

Application specified noise filter

NFZ2MSM Series 0806/2016(inch/mm)

Noise filter for audio lines

Appearance/Dimensions

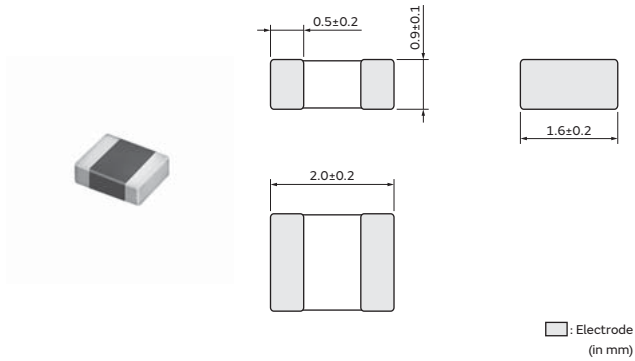

Packaging

Code	Packaging	Minimum Quantity
L	ø180mm Embossed Tape	3000
B	Bulk(Bag)	1000

Equivalent Circuit



(Resistance element becomes dominant at high frequencies.)

Rated Value (□: packaging code)

Part Number	Impedance at 100MHz	Rated Current	DC Resistance	DC Resistance (Max.)
NFZ2MSM101SN10□	100Ω±25%	4A	0.014Ω (Typ.)	0.018Ω
NFZ2MSM181SN10□	180Ω±25%	3.4A	0.020Ω (Typ.)	0.025Ω
NFZ2MSM301SN10□	300Ω±25%	3.1A	0.024Ω (Typ.)	0.03Ω
NFZ2MSM601SN10□	600Ω±25%	2.5A	0.037Ω (Typ.)	0.046Ω

Operating Temp. Range: -40°C to 85°C

Z-f characteristics

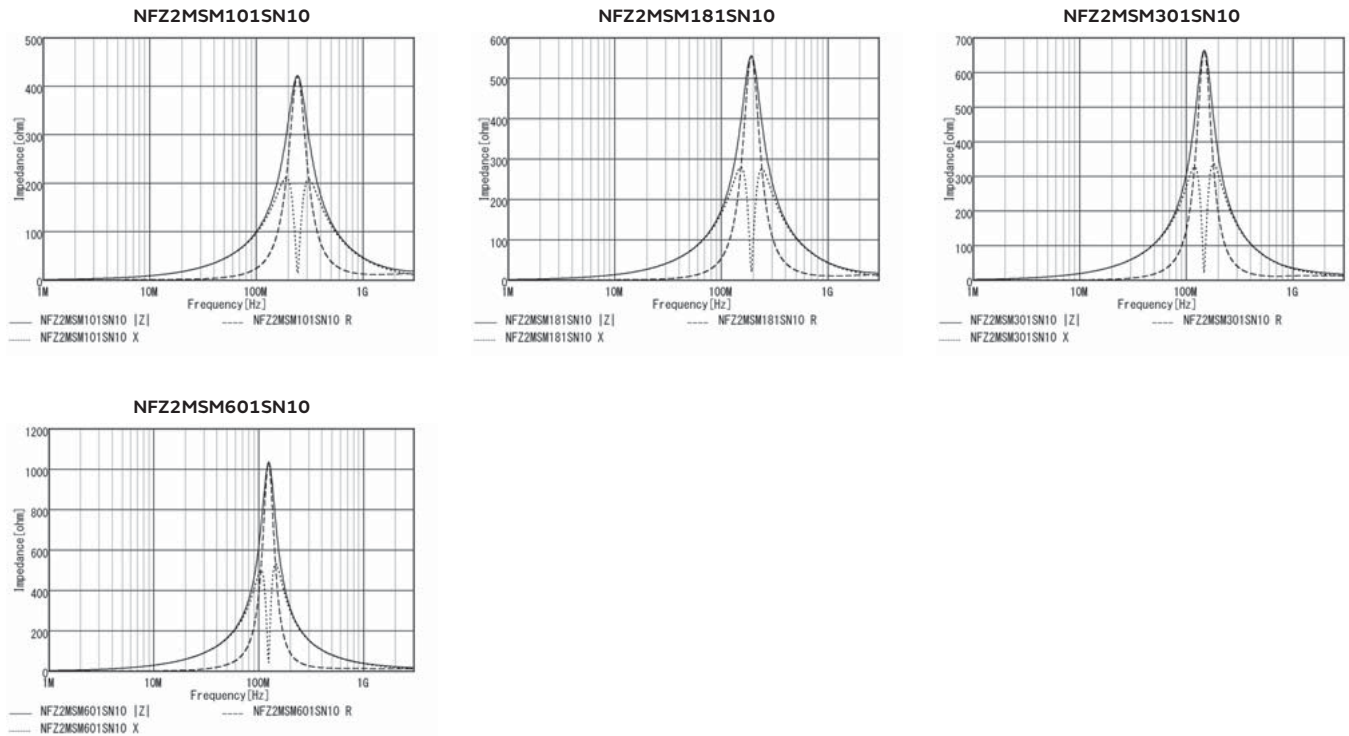

Application specified noise filter

NFZ32SW Series 1210/3225(inch/mm)

Noise filter for audio lines

Appearance/Dimensions

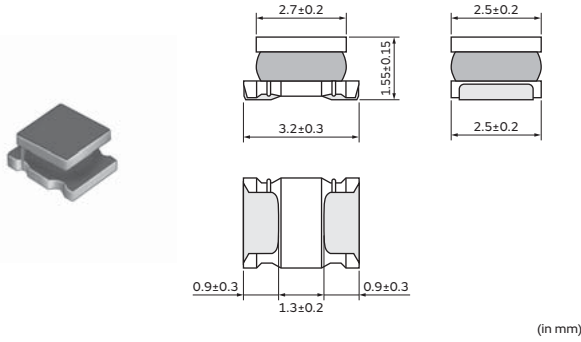

Packaging

Code	Packaging	Minimum Quantity
K	ø330mm Embossed Tape	7500
L	ø180mm Embossed Tape	2000

Equivalent Circuit



(Resistance element becomes dominant at high frequencies.)

Rated Value (□: packaging code)

Part Number	Impedance at 1MHz	Impedance at 100MHz	Rated Current	DC Resistance
NFZ32SW301HN10□	3.2Ω±30%	300Ω(Typ.)	2.55A	0.030Ω±20%
NFZ32SW901HN10□	6.8Ω±30%	900Ω(Typ.)	2.05A	0.045Ω±20%

Operating Temp. Range: -40°C to 85°C

Operating Temp. Range self-temp. rise included: -40°C to 125°C

Z-f characteristics

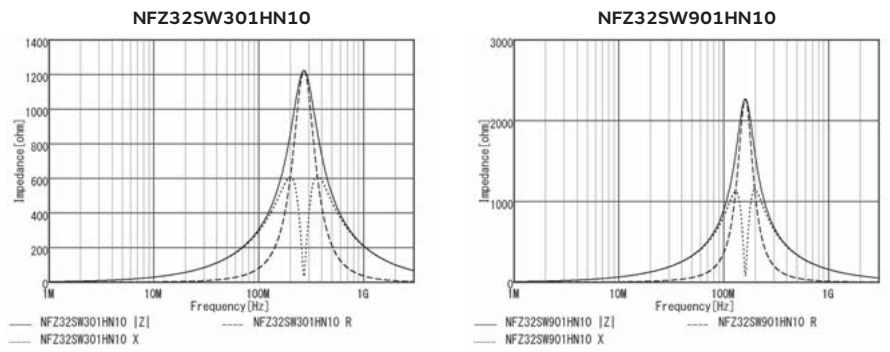

Application specified noise filter

NFZ2HBM Series 1008/2520(inch/mm)

Noise filter for LED lighting equipments

Appearance/Dimensions

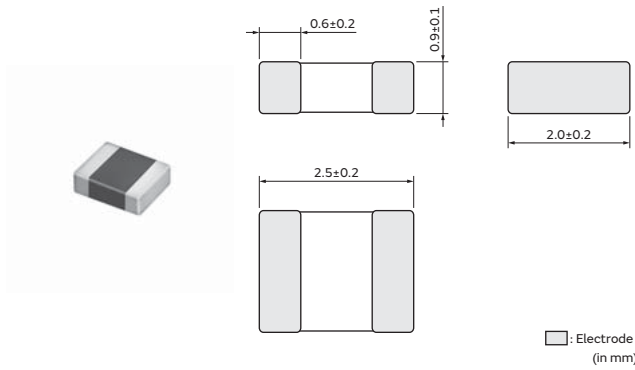

Packaging

Code	Packaging	Minimum Quantity
L	ø180mm Embossed Tape	3000
B	Bulk(Bag)	1000

Equivalent Circuit



(Resistance element becomes dominant at high frequencies.)

Rated Value (□: packaging code)

Part Number	Impedance at 1MHz	Rated Current	DC Resistance
NFZ2HBM1R5SN10□	1.5Ω±30%	1.2A	0.060Ω±25%
NFZ2HBM2R9SN10□	2.9Ω±30%	1.1A	0.085Ω±25%
NFZ2HBM4R4SN10□	4.4Ω±30%	1.05A	0.105Ω±25%
NFZ2HBM6R1SN10□	6.1Ω±30%	1A	0.125Ω±25%
NFZ2HBM8R4SN10□	8.4Ω±30%	900mA	0.145Ω±25%
NFZ2HBM110SN10□	11Ω±30%	800mA	0.160Ω±25%
NFZ2HBM170SN10□	17Ω±30%	700mA	0.210Ω±25%
NFZ2HBM240SN10□	24Ω±30%	650mA	0.250Ω±25%
NFZ2HBM330SN10□	33Ω±30%	500mA	0.300Ω±25%
NFZ2HBM600SN10□	60Ω±30%	400mA	0.300Ω±25%

Operating Temp. Range: -55°C to 125°C

Z-f characteristics

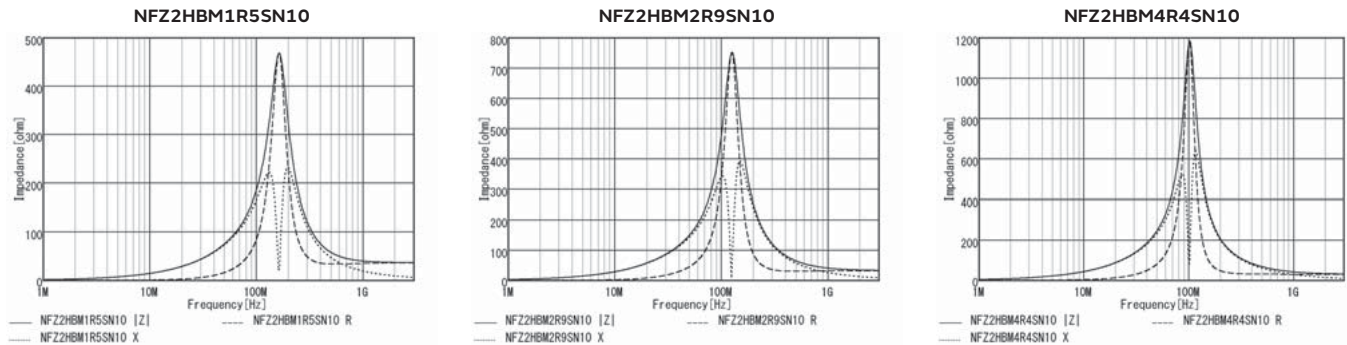

Continued on the following page. ↗

Continued from the preceding page. ↘

Z-f characteristics

NFZ2HBM6R1SN10

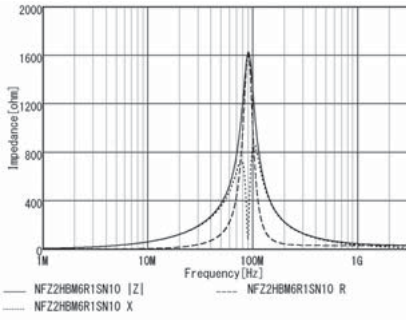

NFZ2HBM8R4SN10

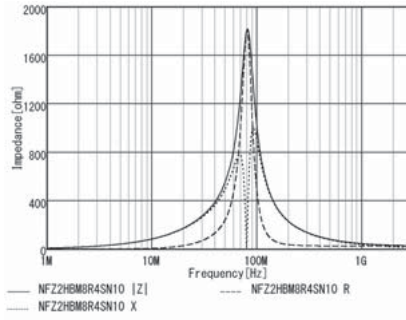

NFZ2HBM110SN10

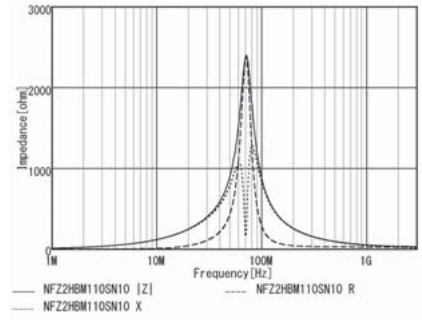

NFZ2HBM170SN10

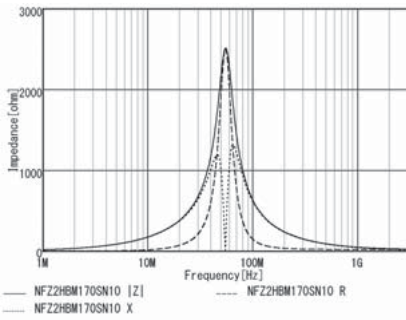

NFZ2HBM240SN10

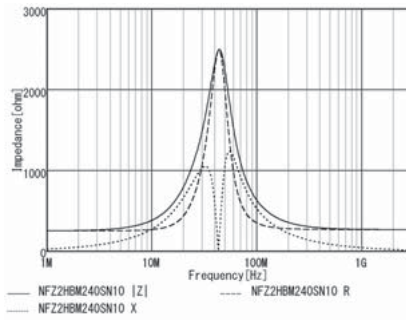

NFZ2HBM330SN10

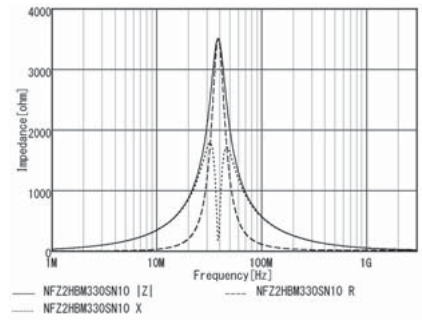

NFZ2HBM600SN10

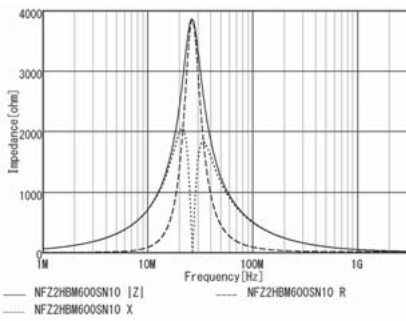

Application specified noise filter

NFZ32BW Series 1210/3225(inch/mm)

Noise filter for LED lighting equipments

Appearance/Dimensions

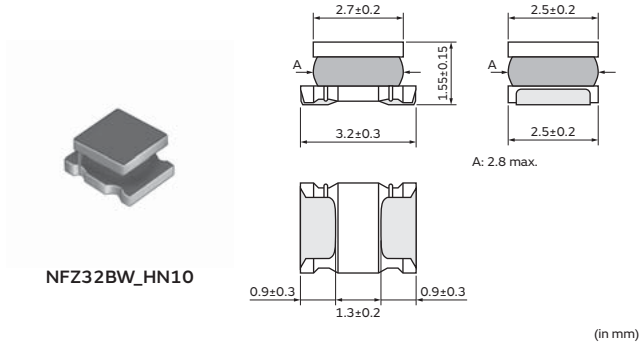

Packaging

Code	Packaging	Minimum Quantity
K	ø330mm Embossed Tape	7500
L	ø180mm Embossed Tape	2000

Equivalent Circuit



(Resistance element becomes dominant at high frequencies.)

Appearance/Dimensions

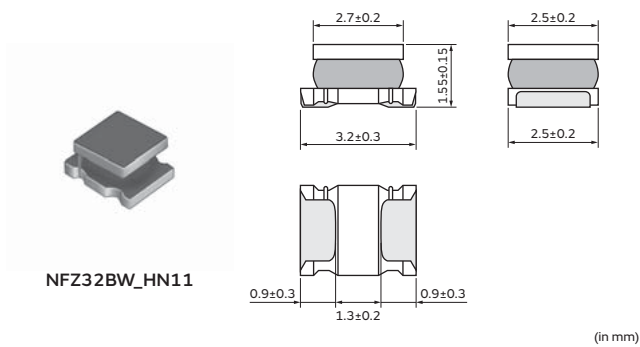

Packaging

Code	Packaging	Minimum Quantity
K	ø330mm Embossed Tape	7500
L	ø180mm Embossed Tape	2000

Equivalent Circuit



(Resistance element becomes dominant at high frequencies.)

Rated Value (□: packaging code)

Part Number	Impedance at 1MHz	Rated Current	DC Resistance
NFZ32BW3R6HN10□	3.6Ω±30%	2.55A	0.03Ω±20%
NFZ32BW7R4HN10□	7.4Ω±30%	2.05A	0.045Ω±20%
NFZ32BW9R0HN10□	9Ω±30%	1.75A	0.057Ω±20%
NFZ32BW150HN10□	15Ω±30%	1.6A	0.076Ω±20%
NFZ32BW210HN10□	21Ω±30%	1.2A	0.12Ω±20%
NFZ32BW320HN10□	32Ω±30%	1A	0.18Ω±20%
NFZ32BW420HN10□	42Ω±30%	850mA	0.24Ω±20%
NFZ32BW700HN10□	70Ω±30%	700mA	0.38Ω±20%
NFZ32BW111HN10□	110Ω±30%	520mA	0.57Ω±20%
NFZ32BW151HN10□	150Ω±30%	450mA	0.81Ω±20%
NFZ32BW221HN10□	220Ω±30%	390mA	1.15Ω±20%
NFZ32BW291HN10□	290Ω±30%	310mA	1.78Ω±20%
NFZ32BW451HN10□	450Ω±30%	275mA	2.28Ω±20%
NFZ32BW621HN10□	620Ω±30%	250mA	2.7Ω±20%
NFZ32BW881HN10□	880Ω±30%	200mA	4.38Ω±20%
NFZ32BW3R3HN11□	3.3Ω±30%	2.9A	0.024Ω±20%
NFZ32BW6R8HN11□	6.8Ω±30%	2.5A	0.036Ω±20%
NFZ32BW8R4HN11□	8.4Ω±30%	2.4A	0.048Ω±20%
NFZ32BW9R8HN11□	9.8Ω±30%	2.1A	0.053Ω±20%

Operating Temp. Range: -40°C to 105°C

Operating Temp. Range self-temp. rise included: -40°C to 125°C

Continued from the preceding page. ↘

Part Number	Impedance at 1MHz	Rated Current	DC Resistance
NFZ32BW120HN11□	12Ω±30%	1.85A	0.064Ω±20%
NFZ32BW190HN11□	19Ω±30%	1.8A	0.089Ω±20%
NFZ32BW210HN11□	21Ω±30%	1.55A	0.100Ω±20%
NFZ32BW310HN11□	31Ω±30%	1.2A	0.155Ω±20%
NFZ32BW520HN11□	52Ω±30%	1.1A	0.220Ω±20%
NFZ32BW650HN11□	65Ω±30%	900mA	0.295Ω±20%
NFZ32BW101HN11□	100Ω±30%	900mA	0.475Ω±20%
NFZ32BW151HN11□	150Ω±30%	700mA	0.685Ω±20%

Operating Temp. Range: -40°C to 105°C

Operating Temp. Range self-temp. rise included: -40°C to 125°C

Z-f characteristics

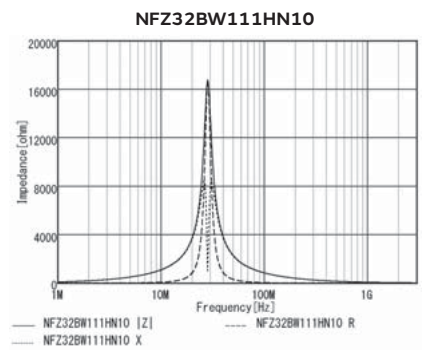
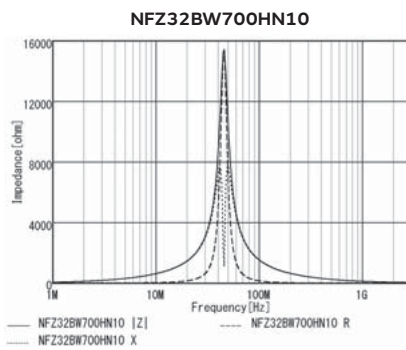
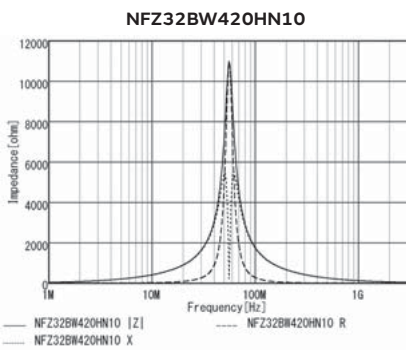
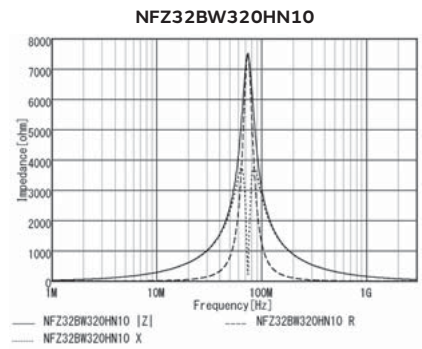
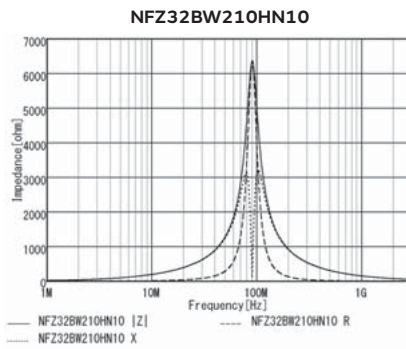
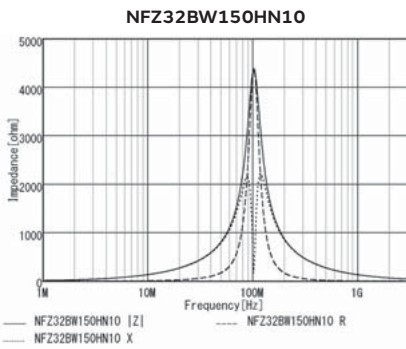
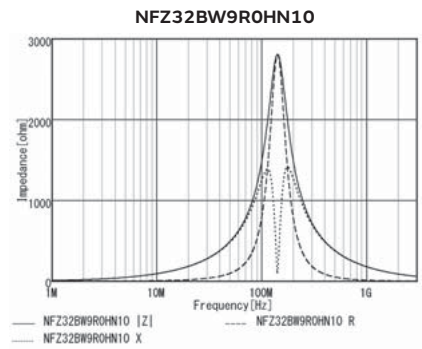
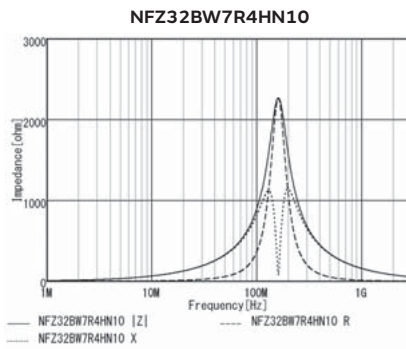
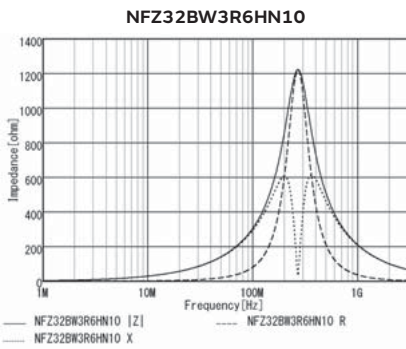

Continued on the following page. ↗

Chip Ferrite Bead

Application Specified Noise Filter

Chip EMIFIL®

Common Mode Choke Coil
Common Mode Noise Filter

Block Type EMIFIL®

EMC Absorber

Continued from the preceding page. ↘

Z-f characteristics

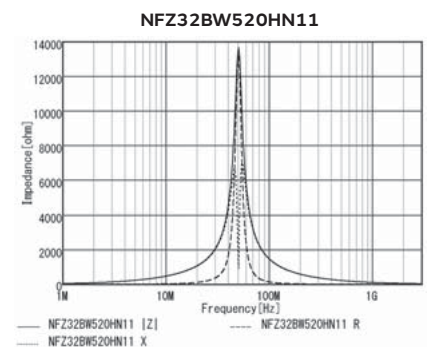
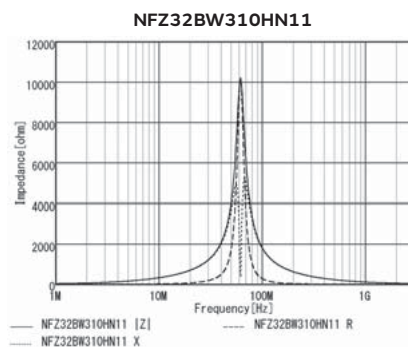
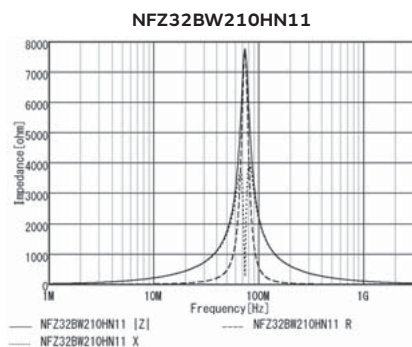
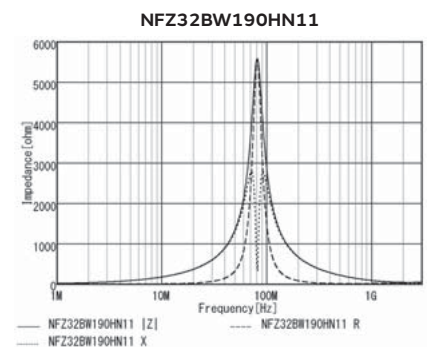
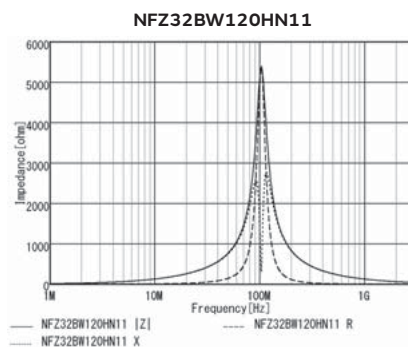
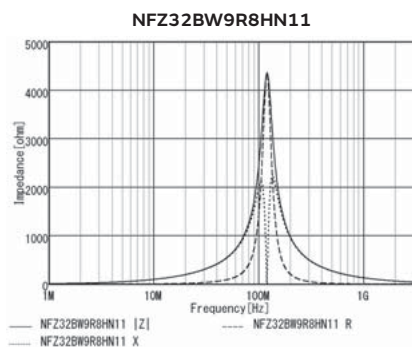
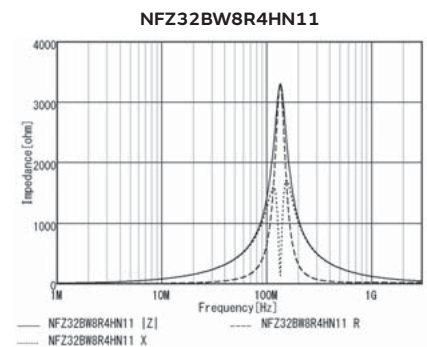
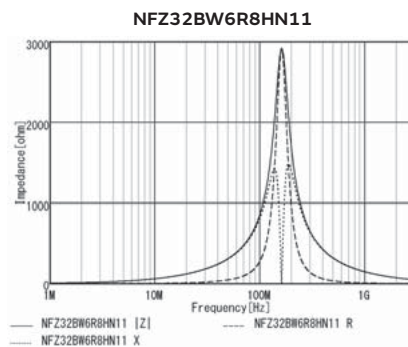
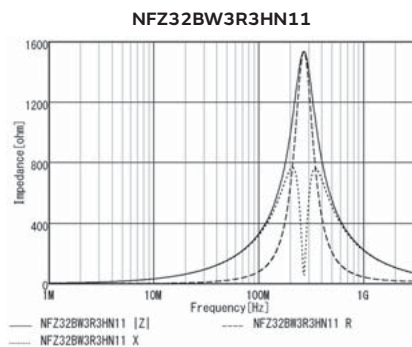
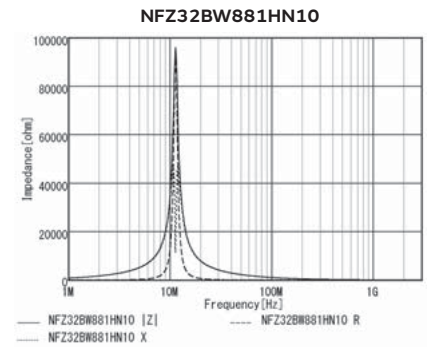
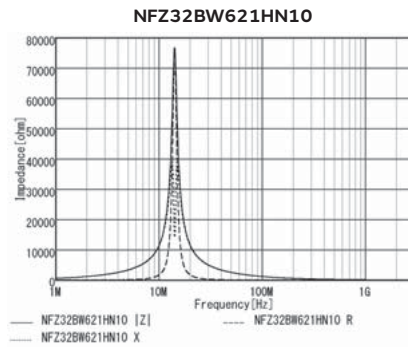
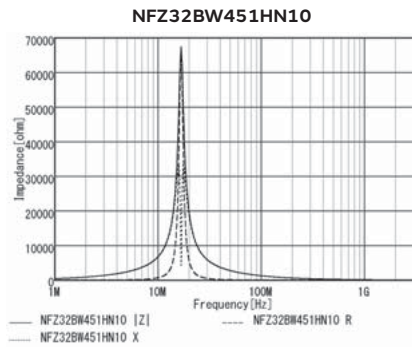
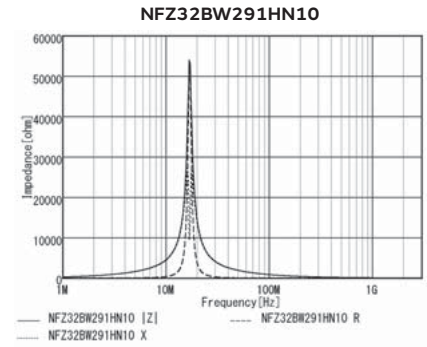
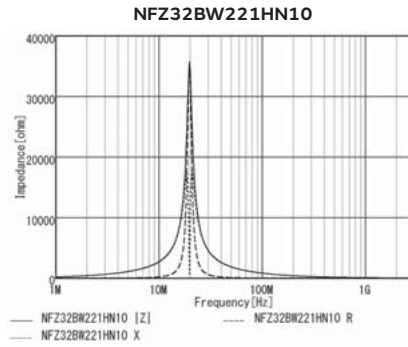
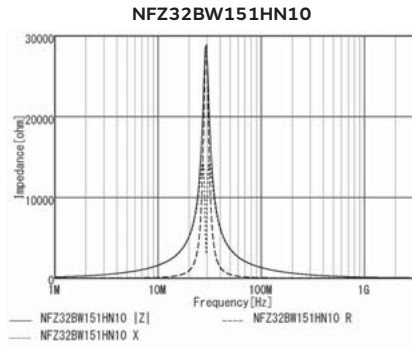

Continued from the preceding page. ↘

Z-f characteristics

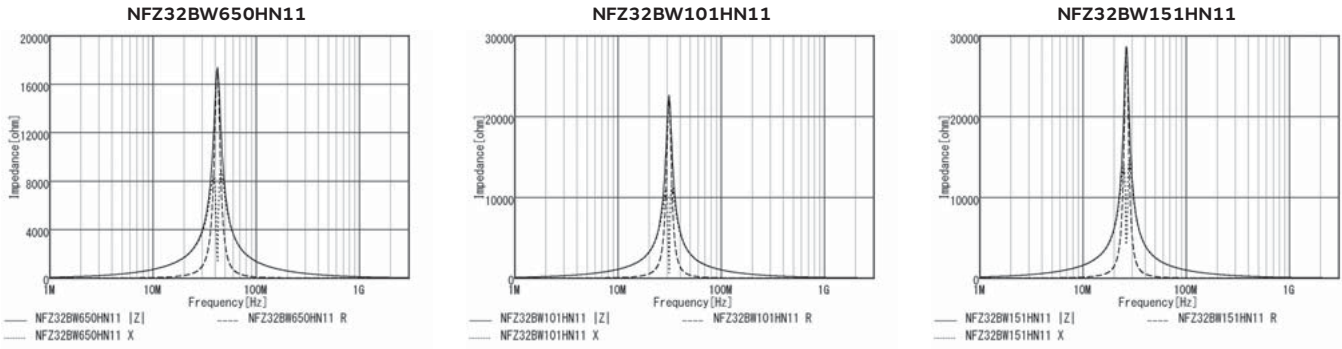

Derating of Rated Current

In operating temperature exceeding +85°C, derating of current is necessary for NFZ32BW_H□10 series. Please apply the derating curve shown in chart according to the operating temperature.

In operating temperature exceeding +85°C, derating of current is necessary for NFZ32BW_H□11 series. Please apply the derating curve shown in chart according to the operating temperature.

Derating of Rated Current

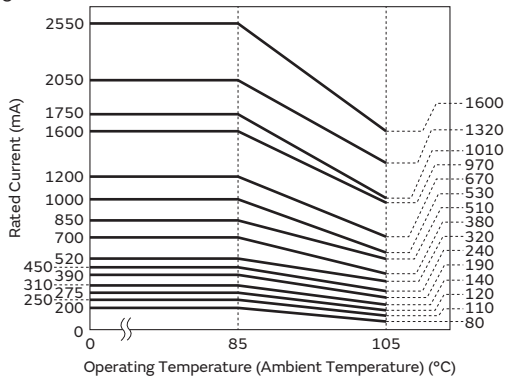

Derating of Rated Current

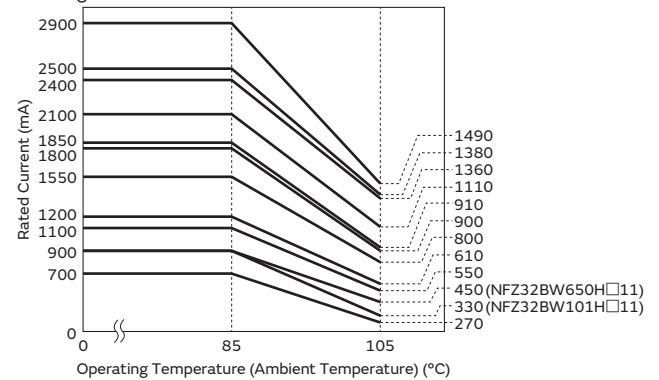

Application specified noise filter

NFZ5BBW Series 2020/5050(inch/mm)

Noise filter for LED lighting equipments

Appearance/Dimensions

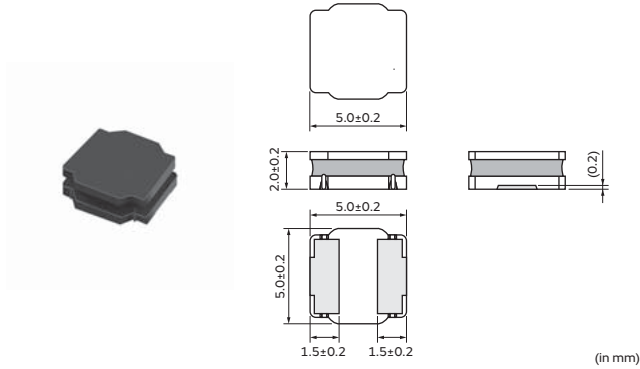

Packaging

Code	Packaging	Minimum Quantity
K	ø330mm Embossed Tape	3000
L	ø180mm Embossed Tape	500

Equivalent Circuit

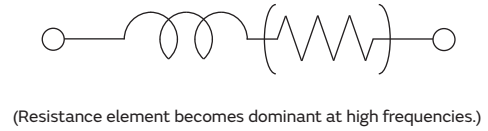

Rated Value (□: packaging code)

Part Number	Impedance at 1MHz	Rated Current	DC Resistance
NFZ5BBW2R9LN10□	2.9Ω±30%	4A	0.012Ω±20%
NFZ5BBW4R5LN10□	4.5Ω±30%	3.4A	0.015Ω±20%
NFZ5BBW6R7LN10□	6.7Ω±30%	3.1A	0.019Ω±20%
NFZ5BBW7R6LN10□	7.6Ω±30%	3.1A	0.019Ω±20%
NFZ5BBW100LN10□	10Ω±30%	3A	0.024Ω±20%
NFZ5BBW140LN10□	14Ω±30%	2.6A	0.030Ω±20%
NFZ5BBW170LN10□	17Ω±30%	2.5A	0.035Ω±20%
NFZ5BBW220LN10□	22Ω±30%	2.3A	0.044Ω±20%
NFZ5BBW310LN10□	31Ω±30%	2A	0.058Ω±20%
NFZ5BBW450LN10□	45Ω±30%	1.65A	0.083Ω±20%
NFZ5BBW520LN10□	52Ω±30%	1.61A	0.100Ω±20%
NFZ5BBW610LN10□	61Ω±30%	1.6A	0.106Ω±20%
NFZ5BBW970LN10□	97Ω±30%	1.2A	0.187Ω±20%
NFZ5BBW141LN10□	140Ω±30%	1.05A	0.259Ω±20%

Operating Temp. Range: -40°C to 105°C

Operating Temp. Range self-temp. rise included: -40°C to 125°C

Z-f characteristics

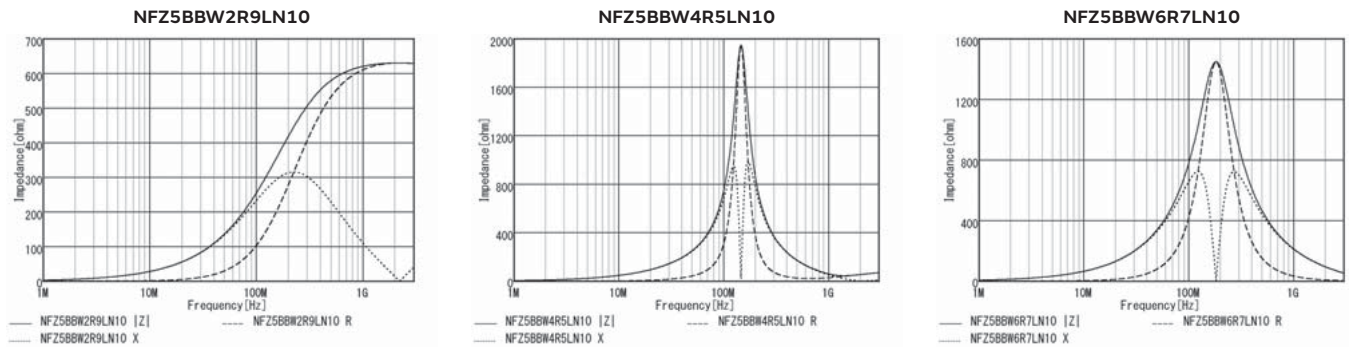

Continued on the following page. ↗

Continued from the preceding page. ↘

Z-f characteristics

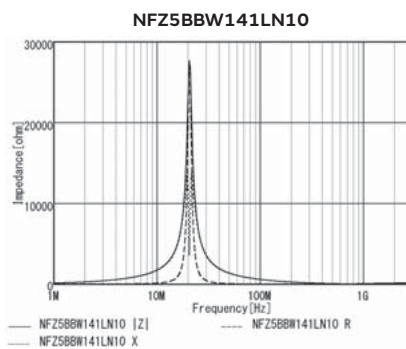
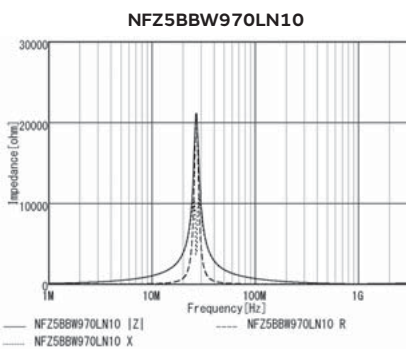
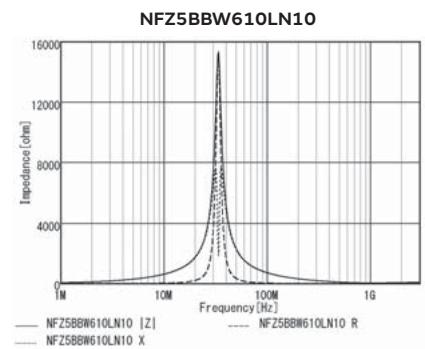
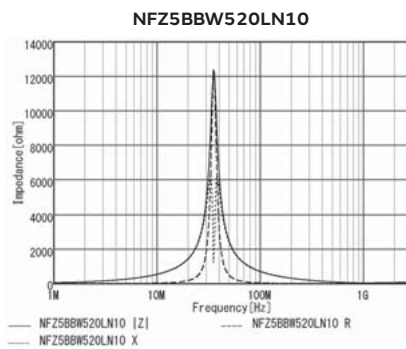
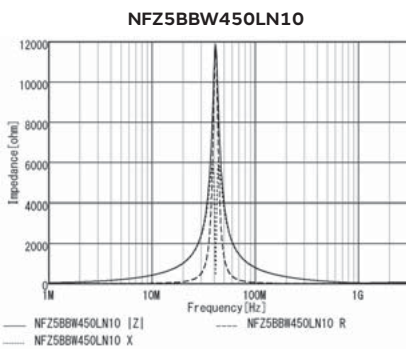
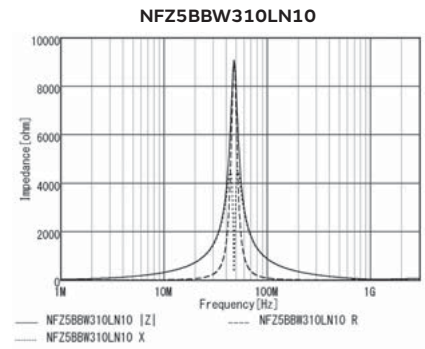
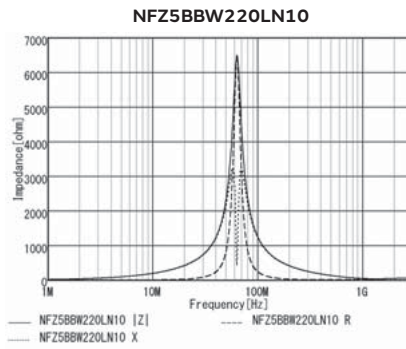
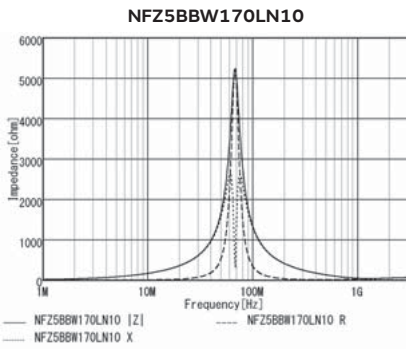
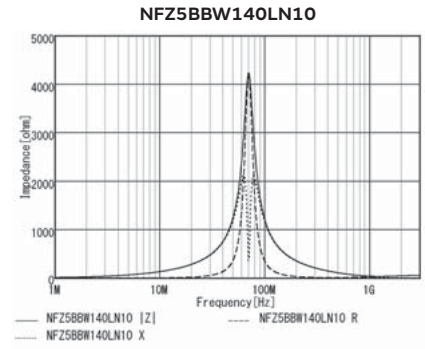
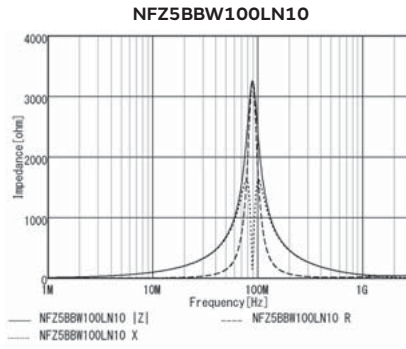
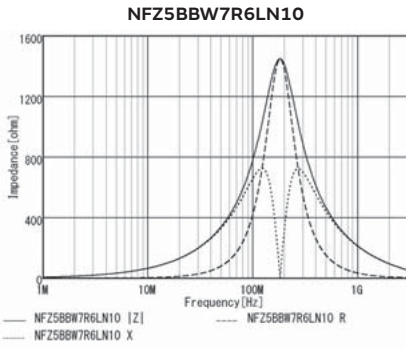

Continued on the following page. ↗

Chip Ferrite Bead

Application Specified Noise Filter

Chip EMIFIL®

Common Mode Choke Coil
 Common Mode Noise Filter

Block Type EMIFIL®

EMC Absorber

Continued from the preceding page. ↘

Derating of Rated Current

In operating temperature exceeding +85°C, derating of current is necessary for NFZ5BBW_L□10 series.
 Please apply the derating curve shown in chart according to the operating temperature.

Derating of Rated Current

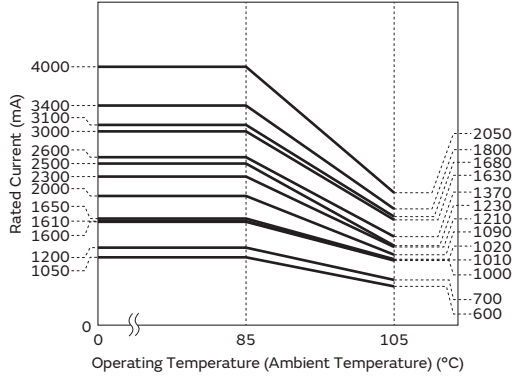

Application specified noise filter

BLF02JD Series 01005/0402(inch/mm)

Frequency specified noise filter

Appearance/Dimensions

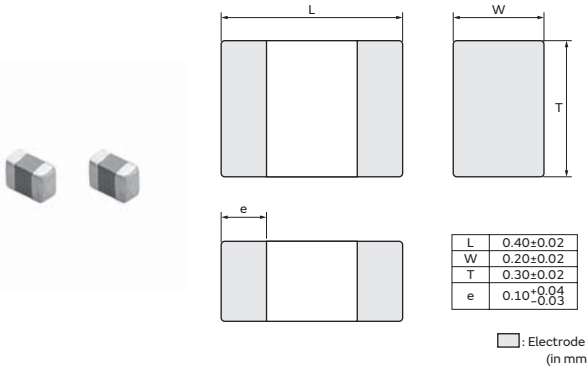

Packaging

Code	Packaging	Minimum Quantity
D	ø180mm Paper Tape	15000
B	Bulk(Bag)	1000

Equivalent Circuit



(Resistance element becomes dominant at high frequencies.)

Rated Value (□: packaging code)

Part Number	Impedance at Target Frequency	Rated Current at 85°C	Rated Current at 125°C	DC Resistance
BLF02JD361GNE□	360Ω±40% (at 700MHz)	380mA	250mA	0.45Ω
BLF02JD471GNE□	470Ω±40% (at 700MHz)	330mA	220mA	0.6Ω

Operating Temp. Range: -55°C to 125°C

Z-f characteristics

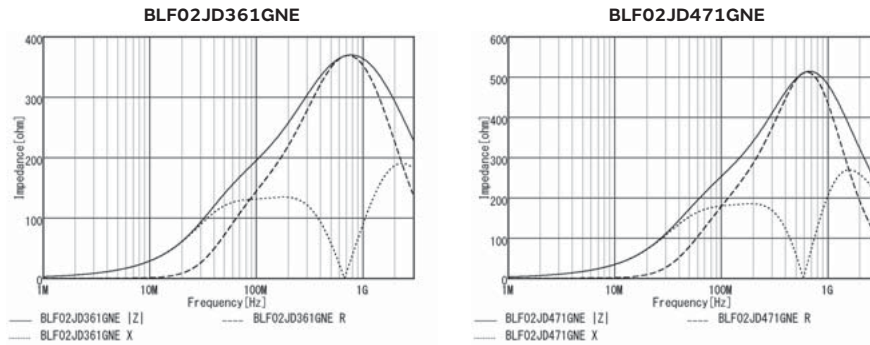

Derating of Rated Current

In operating temperature exceeding +85°C, derating of current is necessary for this series.
 Please apply the derating curve shown in chart according to the operating temperature.

Derating of Rated Current

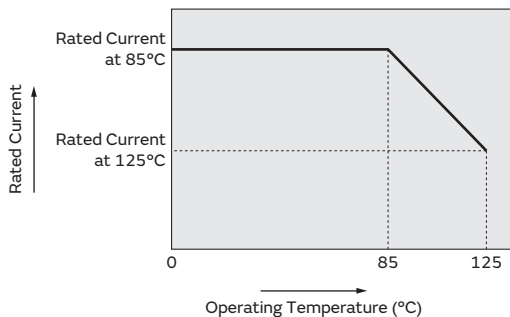

Application specified noise filter

BLF02RD Series 01005/0402(inch/mm)

Frequency specified noise filter

Appearance/Dimensions

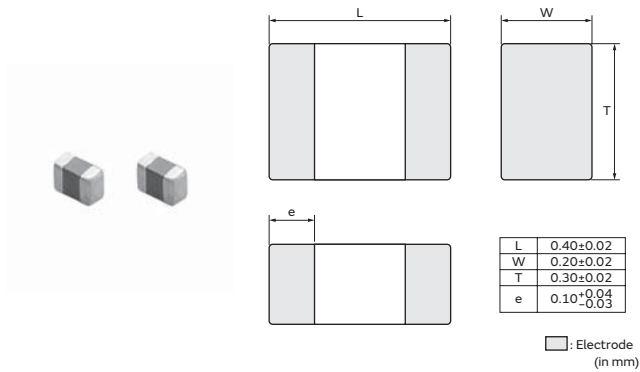

Packaging

Code	Packaging	Minimum Quantity
D	ø180mm Paper Tape	15000
B	Bulk(Bag)	1000

Equivalent Circuit

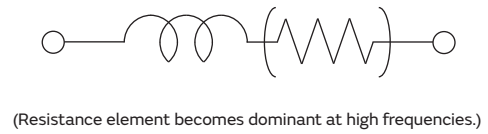

Rated Value (□: packaging code)

Part Number	Impedance at Target Frequency	Rated Current at 85°C	Rated Current at 125°C	DC Resistance
BLF02RD331GNE□	330Ω±40% (at 2.4GHz)	330mA	220mA	0.6Ω
BLF02RD471GNE□	470Ω±40% (at 2.4GHz)	200mA	130mA	0.9Ω

Operating Temp. Range: -55°C to 125°C

Z-f characteristics

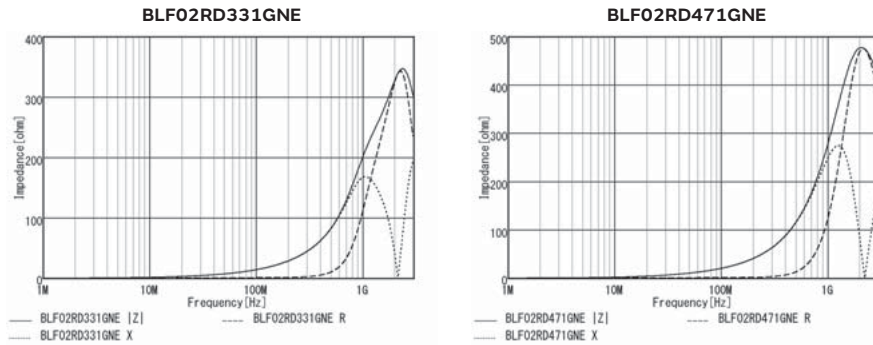

Derating of Rated Current

In operating temperature exceeding +85°C, derating of current is necessary for this series. Please apply the derating curve shown in chart according to the operating temperature.

Derating of Rated Current

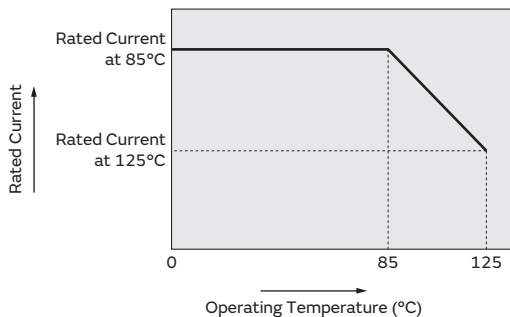

Application specified noise filter

BLF03JD Series 0201/0603(inch/mm)

Frequency specified noise filter

Appearance/Dimensions

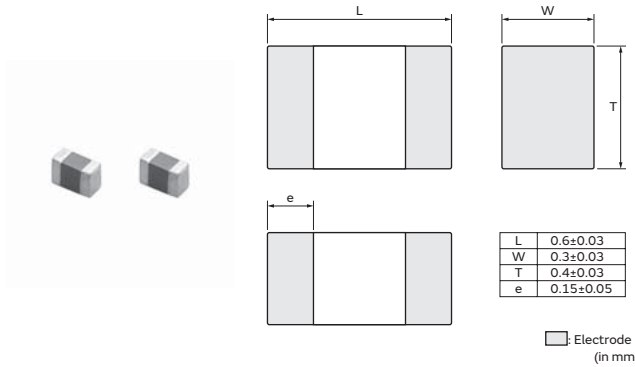

Packaging

Code	Packaging	Minimum Quantity
D	ø180mm Paper Tape	15000
B	Bulk(Bag)	1000

Equivalent Circuit

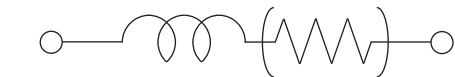

(Resistance element becomes dominant at high frequencies.)

Rated Value (□: packaging code)

Part Number	Impedance at Target Frequency	Rated Current at 85°C	Rated Current at 125°C	DC Resistance	Operating Temp. Range
BLF03JD421GNE□	420Ω±40% (at 700MHz)	480mA	370mA	0.28Ω	-55°C to 125°C

Z-f characteristics

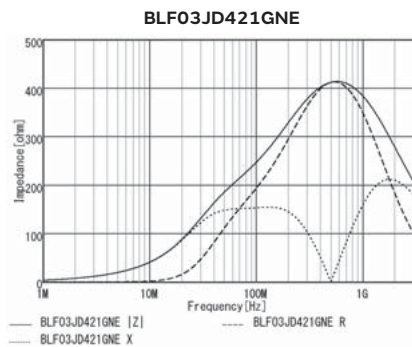

Derating of Rated Current

In operating temperature exceeding +85°C, derating of current is necessary for this series.
 Please apply the derating curve shown in chart according to the operating temperature.

Derating of Rated Current

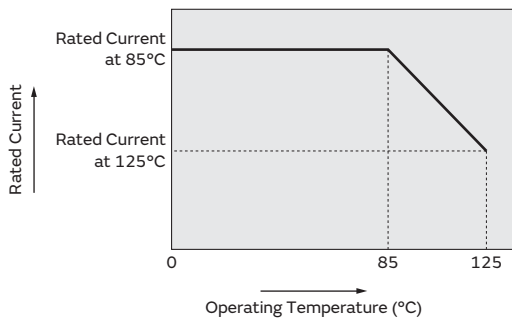

Application specified noise filter

BLE18PS Series 0603/1608(inch/mm)

Noise filter for power charger lines

Appearance/Dimensions

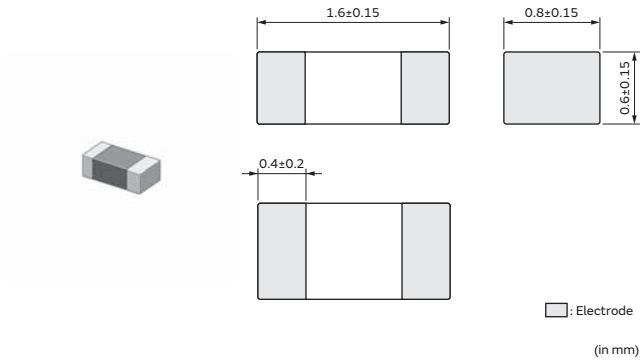

Packaging

Code	Packaging	Minimum Quantity
D	ø180mm Paper Tape	4000
J	ø330mm Paper Tape	10000
B	Bulk(Bag)	1000

Equivalent Circuit

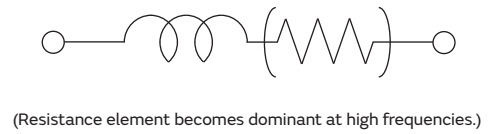

Rated Value (□: packaging code)

Part Number	Impedance at 100MHz	Rated Current at 85°C	Rated Current at 125°C	DC Resistance	Operating Temp. Range
BLE18PS080SN1□	8.5Ω±25%	8A	5A	0.004Ω	-55°C to 125°C

Z-f characteristics

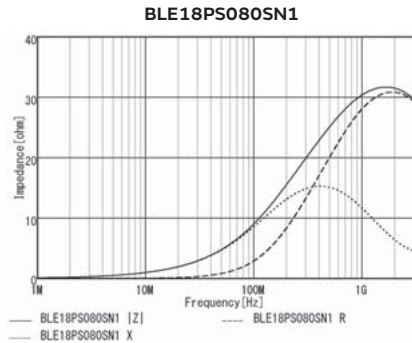

Derating of Rated Current

In operating temperature exceeding +85°C, derating of current is necessary for BLE18PS series. Please apply the derating curve shown in chart according to the operating temperature.

Derating of Rated Current

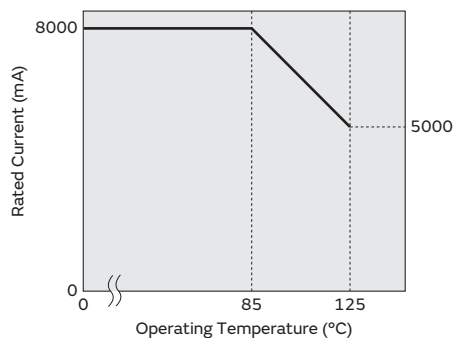

Application specified noise filter

BLE32PN Series 1210/3225(inch/mm)

Noise filter for power charger lines

Appearance/Dimensions

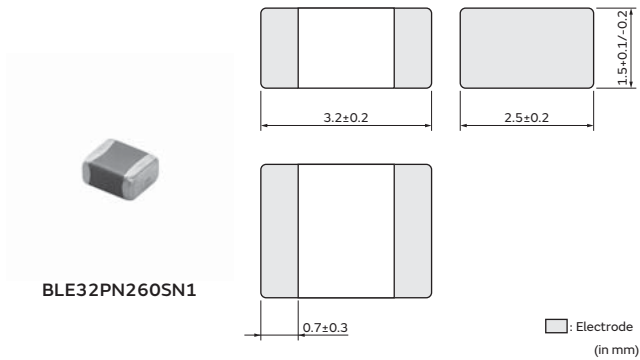

Packaging

Code	Packaging	Minimum Quantity
K	ø330mm Embossed Tape	7000
L	ø180mm Embossed Tape	1500
B	Bulk(Bag)	1000

Equivalent Circuit

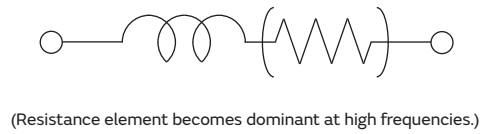

Appearance/Dimensions

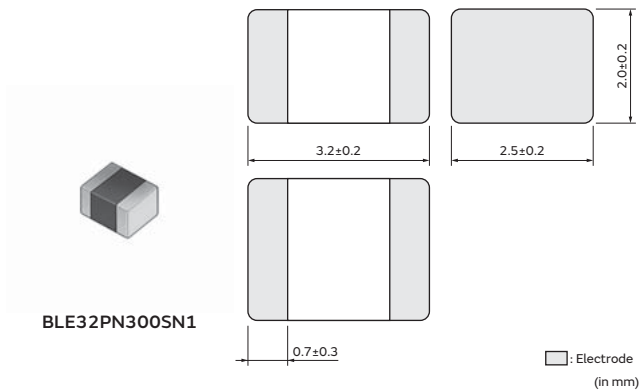

Packaging

Code	Packaging	Minimum Quantity
K	ø330mm Embossed Tape	7000
L	ø180mm Embossed Tape	1500
B	Bulk(Bag)	1000

Equivalent Circuit

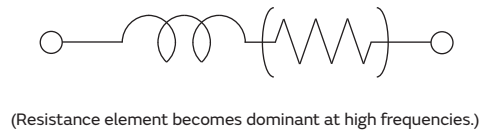

Rated Value (□: packaging code)

Part Number	Impedance at 100MHz	Rated Current at 85°C	Rated Current at 125°C	DC Resistance
BLE32PN260SN1□	26Ω±10Ω	10A	10A	1.6mΩ
BLE32PN300SN1□	30Ω±10Ω	10A	10A	1.6mΩ

Operating Temp. Range: -55°C to 125°C

Z-f characteristics

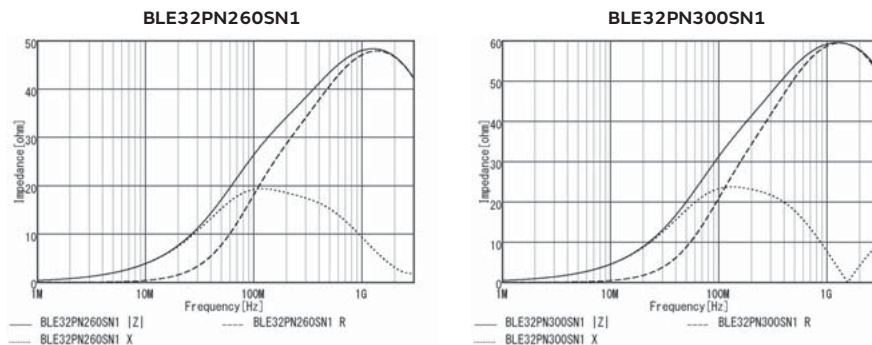

Application Specified Noise Filter

LQW04CA_00 Series 03019/0805(inch/mm)

Inductor for audio line noise suppression

Appearance/Dimensions

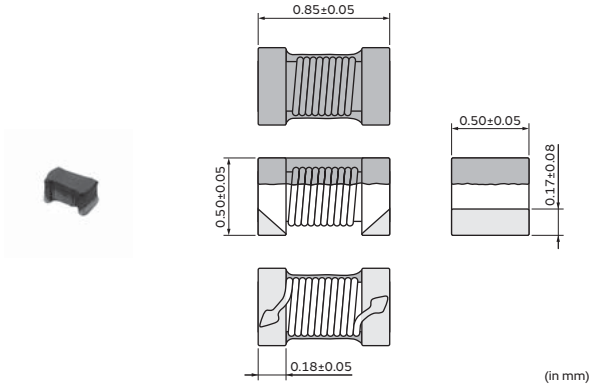

Packaging

Code	Packaging	Minimum Quantity
D	ø180mm Paper Taping	10000
B	Packing in Bulk	500

Rated Value (□: packaging code)

Part Number	Inductance	Inductance Test Frequency	Rated Current	Max. of DC Resistance	S.R.F.* (min.)
LQW04CA60NK00□	60nH ±10%	100MHz	620mA	0.18Ω	3000MHz
LQW04CA90NK00□	90nH ±10%	100MHz	520mA	0.24Ω	2500MHz
LQW04CAR12K00□	120nH ±10%	100MHz	510mA	0.28Ω	2100MHz
LQW04CAR29K00□	290nH ±10%	100MHz	270mA	0.94Ω	1400MHz
LQW04CAR45K00□	450nH ±10%	100MHz	200mA	1.23Ω	850MHz
LQW04CAR51K00□	510nH ±10%	100MHz	200mA	1.31Ω	700MHz

Operating temp. range (Self-temp. rise not included): -40 to 85°C
 Class of Magnetic Shield: No Shield
 For reflow soldering only
 *S.R.F.: Self-Resonant Frequency

Inductance-Frequency Characteristics (Typ.)

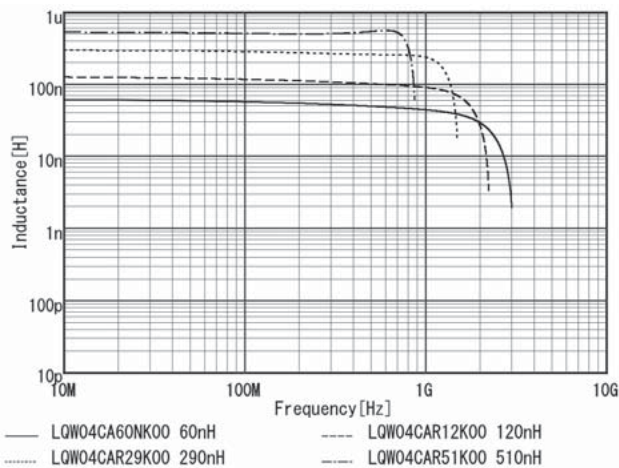

Impedance-Frequency Characteristics (Typ.)

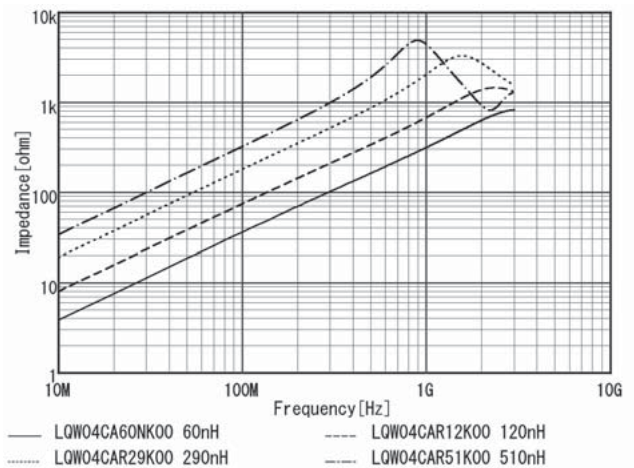

Application Specified Noise Filter

LQW15CA_00 Series 0402/1005(inch/mm)

Inductor for audio line noise suppression

Appearance/Dimensions

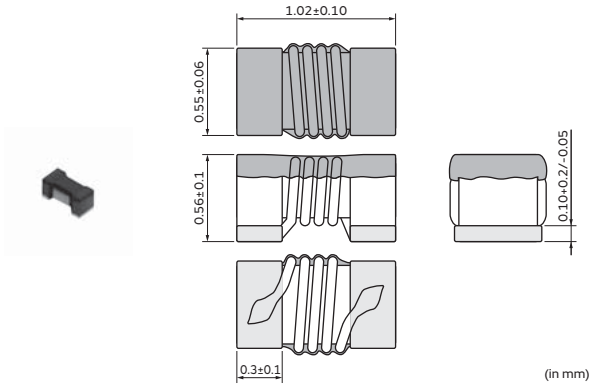

Packaging

Code	Packaging	Minimum Quantity
D	ø180mm Paper Taping	10000
B	Packing in Bulk	500

Rated Value (□: packaging code)

Part Number	Inductance	Inductance Test Frequency	Rated Current	Max. of DC Resistance	S.R.F.* (min.)	Remark
LQW15CA22NJ00□	22nH ±5%	10MHz	1300mA	0.06Ω	3000MHz	*1
LQW15CA22NK00□	22nH ±10%	10MHz	1300mA	0.06Ω	3000MHz	*1
LQW15CA39NJ00□	39nH ±5%	10MHz	1100mA	0.075Ω	2700MHz	*2
LQW15CA39NK00□	39nH ±10%	10MHz	1100mA	0.075Ω	2700MHz	*2
LQW15CA59NJ00□	59nH ±5%	10MHz	1000mA	0.095Ω	2300MHz	*3
LQW15CA59NK00□	59nH ±10%	10MHz	1000mA	0.095Ω	2300MHz	*3
LQW15CA83NJ00□	83nH ±5%	10MHz	970mA	0.12Ω	1700MHz	*4
LQW15CA83NK00□	83nH ±10%	10MHz	970mA	0.12Ω	1700MHz	*4
LQW15CAR11J00□	110nH ±5%	10MHz	900mA	0.13Ω	1600MHz	*5
LQW15CAR11K00□	110nH ±10%	10MHz	900mA	0.13Ω	1600MHz	*5
LQW15CAR14J00□	140nH ±5%	10MHz	680mA	0.18Ω	1400MHz	*6
LQW15CAR14K00□	140nH ±10%	10MHz	680mA	0.18Ω	1400MHz	*6
LQW15CAR18J00□	180nH ±5%	10MHz	640mA	0.21Ω	1300MHz	*7
LQW15CAR18K00□	180nH ±10%	10MHz	640mA	0.21Ω	1300MHz	*7
LQW15CAR22J00□	220nH ±5%	10MHz	540mA	0.29Ω	1300MHz	*8
LQW15CAR22K00□	220nH ±10%	10MHz	540mA	0.29Ω	1300MHz	*8
LQW15CAR27J00□	270nH ±5%	10MHz	480mA	0.38Ω	1200MHz	*9

Operating temp. range (Self-temp. rise included): -40 to 125°C

Class of Magnetic Shield: No Shield

For reflow soldering only

*S.R.F.: Self-Resonant Frequency

*1: Typical impedance: 100Ω (typ) @900MHz/150Ω (typ) @1.7GHz

*2: Typical impedance: 180Ω (typ) @900MHz/280Ω (typ) @1.7GHz

*3: Typical impedance: 290Ω (typ) @900MHz/360Ω (typ) @1.7GHz

*4: Typical impedance: 430Ω (typ) @900MHz/750Ω (typ) @1.7GHz

*5: Typical impedance: 580Ω (typ) @900MHz/1000Ω (typ) @1.7GHz

*6: Typical impedance: 780Ω (typ) @900MHz/1300Ω (typ) @1.7GHz

*7: Typical impedance: 1000Ω (typ) @900MHz/1700Ω (typ) @1.7GHz

*8: Typical impedance: 1400Ω (typ) @900MHz/2000Ω (typ) @1.7GHz

*9: Typical impedance: 1800Ω (typ) @900MHz/2100Ω (typ) @1.7GHz

*10: Typical impedance: 2200Ω (typ) @900MHz/2300Ω (typ) @1.7GHz

*11: Typical impedance: 2800Ω (typ) @900MHz/2350Ω (typ) @1.7GHz

*12: Typical impedance: 3000Ω (typ) @900MHz/2400Ω (typ) @1.7GHz

*13: Typical impedance: 3400Ω (typ) @900MHz/2400Ω (typ) @1.7GHz

*14: Typical impedance: 4250Ω (typ) @900MHz/2400Ω (typ) @1.7GHz

*15: Typical impedance: 4950Ω (typ) @900MHz/2350Ω (typ) @1.7GHz

*16: Typical impedance: 5800Ω (typ) @900MHz/2400Ω (typ) @1.7GHz

*17: Typical impedance: 6500Ω (typ) @900MHz/2450Ω (typ) @1.7GHz

*18: Typical impedance: 7000Ω (typ) @900MHz/2500Ω (typ) @1.7GHz

*19: Typical impedance: 5200Ω (typ) @900MHz/1600Ω (typ) @1.7GHz

*20: Typical impedance: 510Ω (typ) @900MHz/610Ω (typ) @1.7GHz

Continued from the preceding page. ↘

Part Number	Inductance	Inductance Test Frequency	Rated Current	Max. of DC Resistance	S.R.F.* (min.)	Remark
LQW15CAR27K00□	270nH ±10%	10MHz	480mA	0.38Ω	1200MHz	*9
LQW15CAR32J00□	320nH ±5%	10MHz	420mA	0.41Ω	1100MHz	*10
LQW15CAR32K00□	320nH ±10%	10MHz	420mA	0.41Ω	1100MHz	*10
LQW15CAR37J00□	370nH ±5%	10MHz	360mA	0.575Ω	1000MHz	*11
LQW15CAR37K00□	370nH ±10%	10MHz	360mA	0.575Ω	1000MHz	*11
LQW15CAR39J00□	390nH±5%	10MHz	320mA	0.72Ω	950MHz	*12
LQW15CAR39K00□	390nH±10%	10MHz	320mA	0.72Ω	950MHz	*12
LQW15CAR43J00□	430nH ±5%	10MHz	360mA	0.68Ω	920MHz	*13
LQW15CAR43K00□	430nH ±10%	10MHz	360mA	0.68Ω	920MHz	*13
LQW15CAR50J00□	500nH ±5%	10MHz	270mA	0.97Ω	900MHz	*14
LQW15CAR50K00□	500nH ±10%	10MHz	270mA	0.97Ω	900MHz	*14
LQW15CAR56J00□	560nH ±5%	10MHz	270mA	1.00Ω	900MHz	*15
LQW15CAR56K00□	560nH ±10%	10MHz	270mA	1.00Ω	900MHz	*15
LQW15CAR64J00□	640nH ±5%	10MHz	240mA	1.40Ω	870MHz	*16
LQW15CAR64K00□	640nH ±10%	10MHz	240mA	1.40Ω	870MHz	*16
LQW15CAR73J00□	730nH ±5%	10MHz	200mA	1.95Ω	810MHz	*17
LQW15CAR73K00□	730nH ±10%	10MHz	200mA	1.95Ω	810MHz	*17
LQW15CAR80J00□	800nH ±5%	10MHz	190mA	2.10Ω	770MHz	*18
LQW15CAR80K00□	800nH ±10%	10MHz	190mA	2.10Ω	770MHz	*18
LQW15CA1R0K00□	1000nH ±10%	10MHz	180mA	2.20Ω	400MHz	*19
LQW15CA2R0K00□	2000nH ±10%	10MHz	130mA	3.20Ω	120MHz	*20

Operating temp. range (Self-temp. rise included): -40 to 125°C

Class of Magnetic Shield: No Shield

For reflow soldering only

*S.R.F.: Self-Resonant Frequency

*1: Typical impedance: 100Ω (typ) @900MHz/150Ω (typ) @1.7GHz

*2: Typical impedance: 180Ω (typ) @900MHz/280Ω (typ) @1.7GHz

*3: Typical impedance: 290Ω (typ) @900MHz/360Ω (typ) @1.7GHz

*4: Typical impedance: 430Ω (typ) @900MHz/750Ω (typ) @1.7GHz

*5: Typical impedance: 580Ω (typ) @900MHz/1000Ω (typ) @1.7GHz

*6: Typical impedance: 780Ω (typ) @900MHz/1300Ω (typ) @1.7GHz

*7: Typical impedance: 1000Ω (typ) @900MHz/1700Ω (typ) @1.7GHz

*8: Typical impedance: 1400Ω (typ) @900MHz/2000Ω (typ) @1.7GHz

*9: Typical impedance: 1800Ω (typ) @900MHz/2100Ω (typ) @1.7GHz

*10: Typical impedance: 2200Ω (typ) @900MHz/2300Ω (typ) @1.7GHz

*11: Typical impedance: 2800Ω (typ) @900MHz/2350Ω (typ) @1.7GHz

*12: Typical impedance: 3000Ω (typ) @900MHz/2400Ω (typ) @1.7GHz

*13: Typical impedance: 3400Ω (typ) @900MHz/2400Ω (typ) @1.7GHz

*14: Typical impedance: 4250Ω (typ) @900MHz/2400Ω (typ) @1.7GHz

*15: Typical impedance: 4950Ω (typ) @900MHz/2350Ω (typ) @1.7GHz

*16: Typical impedance: 5800Ω (typ) @900MHz/2400Ω (typ) @1.7GHz

*17: Typical impedance: 6500Ω (typ) @900MHz/2450Ω (typ) @1.7GHz

*18: Typical impedance: 7000Ω (typ) @900MHz/2500Ω (typ) @1.7GHz

*19: Typical impedance: 5200Ω (typ) @900MHz/1600Ω (typ) @1.7GHz

*20: Typical impedance: 510Ω (typ) @900MHz/610Ω (typ) @1.7GHz

Inductance-Frequency Characteristics (Typ.)

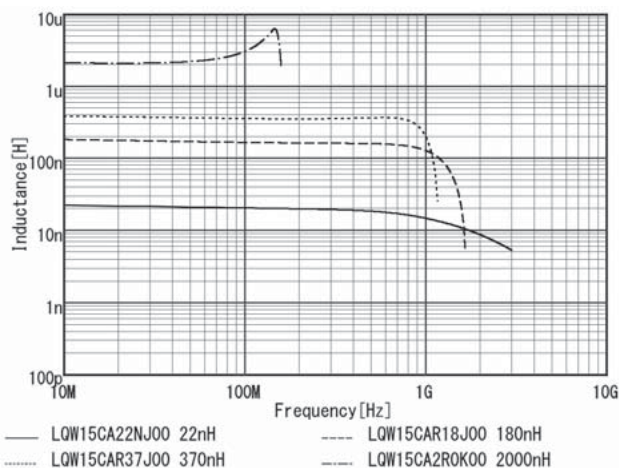

Impedance-Frequency Characteristics (Typ.)

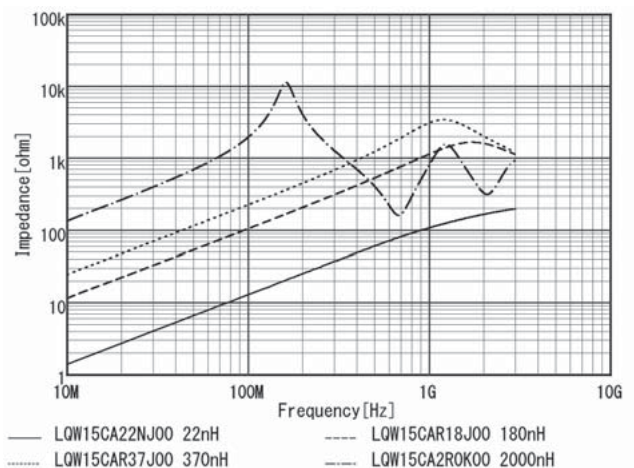

Application Specified Noise Filter

LQW18CA_00 Series 0603/1608(inch/mm)

Inductor for audio line noise suppression

Appearance/Dimensions

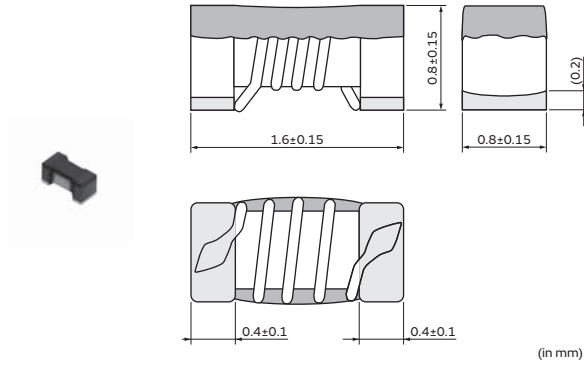

Packaging

Code	Packaging	Minimum Quantity
D	ø180mm Paper Taping	4000
J	ø330mm Paper Taping	10000
B	Packing in Bulk	500

Rated Value (□: packaging code)

Part Number	Inductance	Inductance Test Frequency	Rated Current	Max. of DC Resistance	S.R.F.* (min.)
LQW18CA32NJ00□	32nH±5%	10MHz	2200mA	0.030Ω	3000MHz
LQW18CA56NJ00□	56nH±5%	10MHz	1850mA	0.040Ω	2200MHz
LQW18CA85NJ00□	85nH±5%	10MHz	1650mA	0.048Ω	1800MHz
LQW18CAR12J00□	120nH±5%	10MHz	1500mA	0.058Ω	1500MHz
LQW18CAR16J00□	160nH±5%	10MHz	1300mA	0.075Ω	1350MHz
LQW18CAR21J00□	210nH±5%	10MHz	1050mA	0.115Ω	1150MHz
LQW18CAR27J00□	270nH±5%	10MHz	900mA	0.150Ω	1050MHz
LQW18CAR33J00□	330nH±5%	10MHz	780mA	0.200Ω	970MHz
LQW18CAR40J00□	400nH±5%	10MHz	680mA	0.260Ω	900MHz
LQW18CAR48J00□	480nH±5%	10MHz	580mA	0.350Ω	800MHz
LQW18CAR58J00□	580nH±5%	10MHz	450mA	0.460Ω	760MHz

Operating temp. range (Self-temp. rise not included): -40 to 85°C

Class of Magnetic Shield: No Shield

For reflow soldering only

*S.R.F.: Self-Resonant Frequency

Inductance-Frequency Characteristics (Typ.)

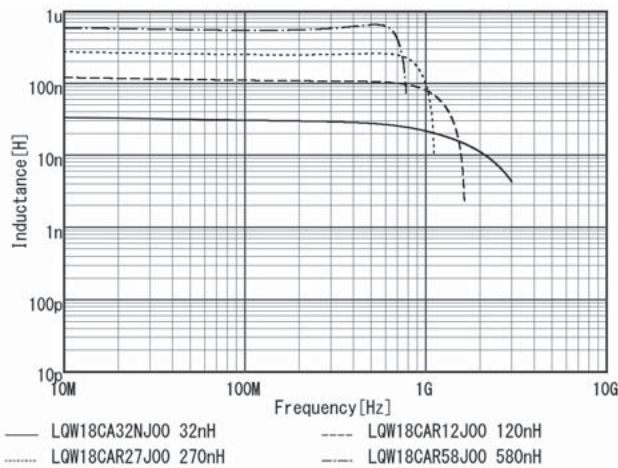

Impedance-Frequency Characteristics (Typ.)

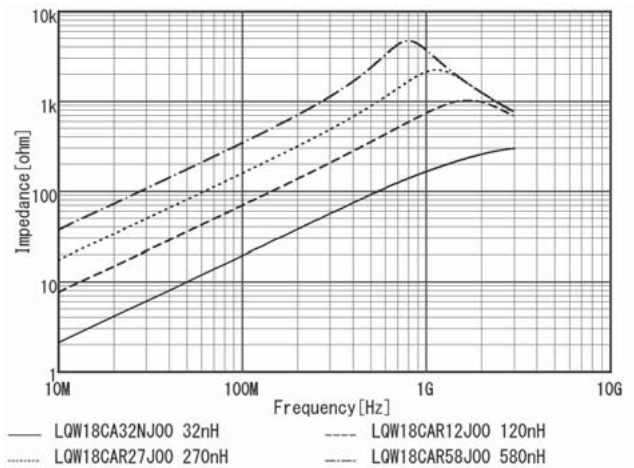

Application Specified Noise Filter (NFZ_S/NFZ_B/BLF/BLE) ⚠Caution/Notice

⚠Caution

Rating

1. About the Rated Current

Do not use products beyond the rated current as this may create excessive heat and deteriorate the insulation resistance.

the specified rated current applied to the product may cause a critical failure, such as an open circuit or burnout caused by excessive temperature rise. Please contact us in advance in case of applying surge current.

2. About Excessive Surge Current

Surge current (pulse current or rush current) higher than

Soldering and Mounting

• Self-heating

Please pay special attention when mounting NFZ03 series in close proximity to other products that radiate heat.

The heat generated by other products may deteriorate the insulation resistance and cause excessive heat in this component.

Notice

Storage and Operating Conditions

<Operating Environment>

Do not use products in a corrodible atmosphere such as acidic gases, alkaline gases, chlorine, sulfur gases, organic gases (a sea breeze, Cl₂, H₂S, NH₃, SO₂, NO₂, etc.).

Do not use products in an environment close to an organic solvent.

<Storage and Handling Requirements>

1. Storage Period

NFZ32B/S · NFZ5B series should be used within 12

months; the other series should be used within 6 months. Solderability should be checked if this period is exceeded.

2. Storage Conditions

(1) Storage temperature: -10 to +40°C

Relative humidity: 15 to 85%

Avoid sudden changes in temperature and humidity.

(2) Do not store products in a chemical atmosphere such as chlorine gas, acid or sulfide gas.

Notice (Soldering and Mounting)

1. Cleaning

Failure and degradation of a product can be caused by the cleaning method. When you clean in conditions that are not in the mounting information, please contact Murata engineering.

2. Soldering

Reliability decreases with improper soldering methods. Please solder by the standard soldering conditions shown in the mounting information.

3. Other

Noise suppression levels resulting from Murata's EMI suppression filters EMIFILr may vary, depending on the circuits and ICs used, type of noise, mounting pattern, mounting location, and other operating conditions. Be sure to check and confirm in advance the noise suppression effect of each filter, in actual circuits, etc. before applying the filter in a commercial-purpose equipment design.

Handling

1. Resin Coating

Using resin for coating/molding products may affect the product's performance. So please pay careful attention in selecting resin. Prior to use, please make a reliability evaluation with the product mounted in your application set.

when cropping the substrate, inserting and removing a connector from the substrate or tightening a screw to the substrate.

Excessive mechanical stress may cause cracking in the product.

2. Handling of Substrates

After mounting products on a substrate, do not apply any stress to the product by bending or twisting the substrate

Bending

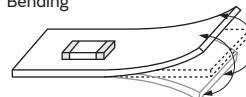

Twisting

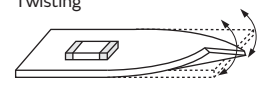

Inductor for Audio Line Noise Suppression (LQW_CA) ⚠Caution/Notice

⚠Caution

Rating

1. About the Rated Current

Do not use products beyond the rated current as this may create excessive heat and deteriorate the insulation resistance.

Notice

Storage and Operating Conditions

<Operating Environment>

Do not use products in a chemical atmosphere such as chlorine gas, acid or sulfide gas.

<Storage Requirements>

1. Storage Period

The LQW_CA series should be used within 12 months. Check solderability if this period is exceeded.

2. Storage Conditions

- (1) Store products in a warehouse in compliance with the following conditions:
Temperature: -10 to +40°C.
Humidity: 15 to 85% (relative humidity)

Do not subject products to rapid changes in temperature and humidity.

Do not store them in a chemical atmosphere such as one containing sulfurous acid gas or alkaline gas. This will prevent electrode oxidation, which causes poor solderability and possible corrosion of inductors.

- (2) Do not store products in bulk packaging to prevent collision among inductors, which causes core chipping and wire breakage.
(3) Store products on pallets to protect from humidity, dust, etc.
(4) Avoid heat shock, vibration, direct sunlight, etc.

Handling

This item is designed to have sufficient strength, but handle with care to avoid chipping or breaking its ceramic structure.

LQW_C series

- To prevent breaking the wire, avoid touching the wire wound portion with sharp materials, such as tweezers or the bristles of a cleaning brush.
- To prevent breaking the core, avoid applying excessive mechanical shock to products mounted on the board.
- In some mounting machines, when picking up components, a support pin pushes the components up from the bottom of the base tape. In this case, please remove the support pin. The support pin may damage the components and break the wire.
- In rare cases, the laser recognition cannot recognize this component. Please contact us when you use laser recognition. (There is no problem with the permeation and reflection type.)
- The product temperature rises about 40°C maximum when the permissible current is applied to LQW15C/LQW18C. Please use caution regarding the temperature of the substrate and air around the part.

<Transportation>

Do not apply excessive vibration or mechanical shock to products.

<Resin Coating>

When coating products with resin, the relatively high resin curing stress may change inductance values. For exterior coating, select resin carefully so that electrical and mechanical performance of the product is not affected. Prior to use, please evaluate reliability with the product mounted in your application set.

(LQW series)

An open circuit issue may occur by mechanical stress caused by the resin, amount/cured shape of resin, or operating conditions, etc. Some resins containing impurities or chloride may possibly generate chlorine by hydrolysis under some operating conditions, causing corrosion of the inductor wire and leading to an open circuit.

<Rated Current>

- Rated Current Based on Temperature Rise
Please refer to individual specifications.

Continued on the following page. ↗

Inductor for Audio Line Noise Suppression (LQW_CA) ⚠Caution/Notice

Continued from the preceding page. ↘

<Handling of Substrates>

After mounting products on a substrate, do not apply any stress to the product caused by bending or twisting the substrate when cropping the substrate, inserting and removing a connector from the substrate, or tightening a screw to the substrate.

Excessive mechanical stress may cause cracking in the product.



Measuring Method

Measuring Method of Inductance/Q

1. Residual elements and stray elements of test fixtures can be described by F-parameter as shown in the following:

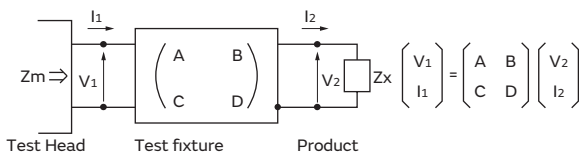

2. The impedance of chip inductors (chip coils) Z_x and measured value Z_m can be described by input/output current/voltage.

$$Z_m = \frac{V_1}{I_1}, \quad Z_x = \frac{V_2}{I_2}$$

3. Thus, the relation between Z_x and Z_m is shown in the following:

$$Z_x = \alpha \frac{Z_m - \beta}{1 - Z_m \Gamma}$$

where, $\alpha = D / A = 1$
 $\beta = B / D = Z_{sm} - (1 - Y_{om} Z_{sm}) Z_{ss}$
 $\Gamma = C / A = Y_{om}$

(Z_{sm} : measured impedance of short chip
 Z_{ss} : residual impedance of short chip*
 Y_{om} : measured admittance when opening the fixture)

*Residual inductance of short chip

Residual Inductance	Series
0.556nH	LQW04CA/15CA
0.771nH	LQW18CA

4. L_x should be calculated with the following equation.

$$L_x = \frac{\text{Im}(Z_x)}{2\pi f}$$

L_x : Inductance of chip Inductors (chip coils)
 f : Measuring frequency

Application Specified Noise Filter (NFZ_S/NFZ_B/BLF/BLE) Soldering and Mounting

1. Standard Land Pattern Dimensions

Land Pattern + Solder Resist
 Land Pattern
 Solder Resist
 (in mm)

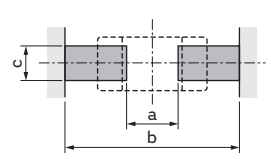
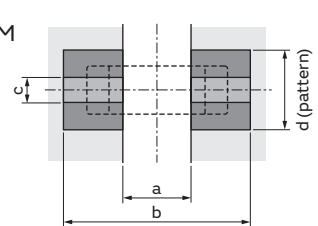
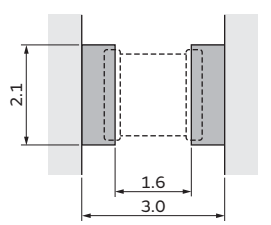
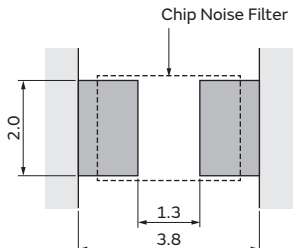
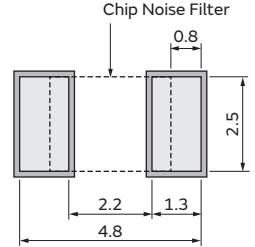
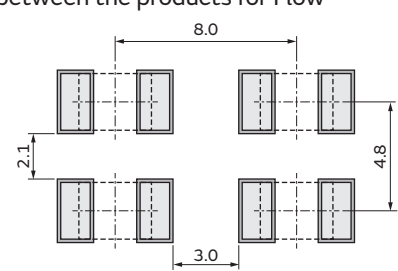
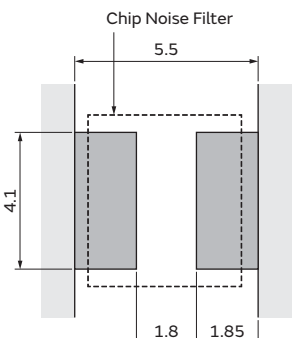
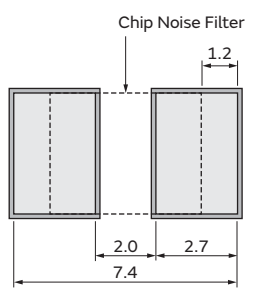
Series	Standard Land Dimensions																																																					
NFZ03 NFZ15 NFZ18 NFZ2M	<p>●Reflow Soldering NFZ03/15</p>  <table border="1" style="margin-top: 10px;"> <thead> <tr> <th>Type</th> <th>Soldering</th> <th>a</th> <th>b</th> <th>c</th> </tr> </thead> <tbody> <tr> <td>NFZ03</td> <td>Reflow</td> <td>0.25</td> <td>0.8</td> <td>0.3</td> </tr> <tr> <td>NFZ15</td> <td>Reflow</td> <td>0.4</td> <td>1.2-1.4</td> <td>0.5</td> </tr> </tbody> </table>	Type	Soldering	a	b	c	NFZ03	Reflow	0.25	0.8	0.3	NFZ15	Reflow	0.4	1.2-1.4	0.5	<p>NFZ18 · NFZ2M</p>  <table border="1" style="margin-top: 10px;"> <thead> <tr> <th rowspan="2">Type</th> <th rowspan="2">Rated Current (A)</th> <th rowspan="2">Soldering</th> <th rowspan="2">a</th> <th rowspan="2">b</th> <th rowspan="2">c</th> <th colspan="3">Land Pad Thickness and Dimension d</th> </tr> <tr> <th>18μm</th> <th>35μm</th> <th>70μm</th> </tr> </thead> <tbody> <tr> <td>NFZ18</td> <td>0-1.25</td> <td>Reflow</td> <td>0.7</td> <td>1.8-2.0</td> <td>0.7</td> <td>0.7</td> <td>0.7</td> </tr> <tr> <td rowspan="3">NFZ2M</td> <td>0-1.5</td> <td rowspan="3">Reflow</td> <td rowspan="3">0.8</td> <td rowspan="3">2.4</td> <td rowspan="3">1.8</td> <td>1.8</td> <td>1.8</td> <td>1.8</td> </tr> <tr> <td>1.5-2.5</td> <td>2.4</td> <td>1.8</td> <td>1.8</td> </tr> <tr> <td>2.5-5.0</td> <td>5.0</td> <td>2.4</td> <td>1.8</td> </tr> </tbody> </table>	Type	Rated Current (A)	Soldering	a	b	c	Land Pad Thickness and Dimension d			18μm	35μm	70μm	NFZ18	0-1.25	Reflow	0.7	1.8-2.0	0.7	0.7	0.7	NFZ2M	0-1.5	Reflow	0.8	2.4	1.8	1.8	1.8	1.8	1.5-2.5	2.4	1.8	1.8	2.5-5.0	5.0	2.4	1.8
Type	Soldering	a	b	c																																																		
NFZ03	Reflow	0.25	0.8	0.3																																																		
NFZ15	Reflow	0.4	1.2-1.4	0.5																																																		
Type	Rated Current (A)	Soldering	a	b	c	Land Pad Thickness and Dimension d																																																
						18μm	35μm	70μm																																														
NFZ18	0-1.25	Reflow	0.7	1.8-2.0	0.7	0.7	0.7																																															
NFZ2M	0-1.5	Reflow	0.8	2.4	1.8	1.8	1.8	1.8																																														
	1.5-2.5					2.4	1.8	1.8																																														
	2.5-5.0					5.0	2.4	1.8																																														
NFZ2H	<p>●Reflow and Flow</p> 																																																					
NFZ32	<p>●Reflow Soldering NFZ32BW/32SW</p> 	<p>●Flow Soldering NFZ32BW</p>  <p>Distance between the products for Flow</p> 																																																				
NFZ5B	<p>●Reflow Soldering</p> 	<p>●Flow Soldering</p> 																																																				

Chip Ferrite Bead

Application Specified Noise Filter

Chip EMIFIL®

Common Mode Choke Coil
Common Mode Noise Filter

Block Type EMIFIL®

EMC Absorber

Application Specified Noise Filter (NFZ_S/NFZ_B/BLF/BLE) Soldering and Mounting

Continued from the preceding page. ↘

Land Pattern + Solder Resist
 Land Pattern
 Solder Resist
 (in mm)

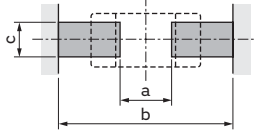
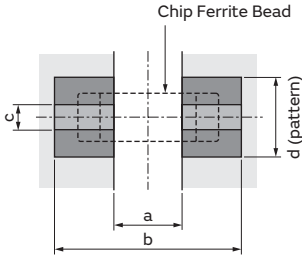
Series	Standard Land Dimensions																																				
BLF02 BLF03	●Reflow Soldering																																				
					<table border="1"> <thead> <tr> <th>Type</th> <th>Soldering</th> <th>a</th> <th>b</th> <th>c</th> </tr> </thead> <tbody> <tr> <td>BLF02</td> <td>Reflow</td> <td>0.18</td> <td>0.48</td> <td>0.215</td> </tr> <tr> <td>BLF03</td> <td>Reflow</td> <td>0.25</td> <td>0.8</td> <td>0.3</td> </tr> </tbody> </table>				Type	Soldering	a	b	c	BLF02	Reflow	0.18	0.48	0.215	BLF03	Reflow	0.25	0.8	0.3														
Type	Soldering	a	b	c																																	
BLF02	Reflow	0.18	0.48	0.215																																	
BLF03	Reflow	0.25	0.8	0.3																																	
BLE18 BLE32	●Reflow and Flow																																				
					<table border="1"> <thead> <tr> <th rowspan="2">Type</th> <th rowspan="2">Rated Current (A)</th> <th rowspan="2">Soldering</th> <th rowspan="2">a</th> <th rowspan="2">b</th> <th rowspan="2">c</th> <th colspan="3">Land Pad Thickness and Dimension d</th> </tr> <tr> <th>18μm</th> <th>35μm</th> <th>70μm</th> </tr> </thead> <tbody> <tr> <td>BLE18</td> <td>8</td> <td>Flow/ Reflow</td> <td>Flow/ 0.8 Reflow 0.7</td> <td>Flow/ 2.5 Reflow 2.0</td> <td>0.7</td> <td>-</td> <td>6.4</td> <td>3.3</td> </tr> <tr> <td>BLE32</td> <td>10</td> <td>Flow/ Reflow</td> <td>2.2</td> <td>4.4</td> <td>2.05</td> <td>-</td> <td>4.0 (85°C max.) 8.0 (125°C max.)</td> <td>-</td> </tr> </tbody> </table>				Type	Rated Current (A)	Soldering	a	b	c	Land Pad Thickness and Dimension d			18μm	35μm	70μm	BLE18	8	Flow/ Reflow	Flow/ 0.8 Reflow 0.7	Flow/ 2.5 Reflow 2.0	0.7	-	6.4	3.3	BLE32	10	Flow/ Reflow	2.2	4.4	2.05	-	4.0 (85°C max.) 8.0 (125°C max.)
Type	Rated Current (A)	Soldering	a	b	c	Land Pad Thickness and Dimension d																															
						18μm	35μm	70μm																													
BLE18	8	Flow/ Reflow	Flow/ 0.8 Reflow 0.7	Flow/ 2.5 Reflow 2.0	0.7	-	6.4	3.3																													
BLE32	10	Flow/ Reflow	2.2	4.4	2.05	-	4.0 (85°C max.) 8.0 (125°C max.)	-																													

●PCB Warping

PCB should be designed so that products are not subjected to mechanical stress caused by warping the board.

Products should be located in a sideways direction (Length: $a < b$) to the mechanical stress.

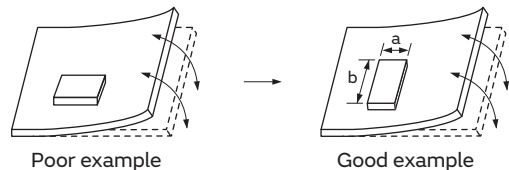

Poor example Good example

2. Solder Paste Printing and Adhesive Application

When reflow soldering the application specified noise filter, the printing must be conducted in accordance with the following cream solder printing conditions.



If too much solder is applied, the chip will be prone to damage by mechanical and thermal stress from the PCB and may crack.

Standard land dimensions should be used for resist and copper foil patterns.

When flow soldering the application specified noise filter, apply the adhesive in accordance with the following conditions.

If too much adhesive is applied, it may overflow into the land or termination areas and yield poor solderability. In contrast, if insufficient adhesive is applied, or if the adhesive is not sufficiently hardened, then the chip may become detached during the flow soldering process.

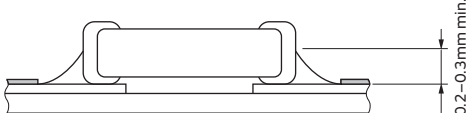
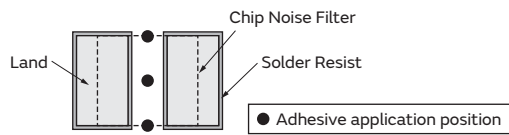
(in mm)

Series	Solder Paste Printing	Adhesive Application
BLE	<p>●Guideline of solder paste thickness: 50-80μm: BLF02/03 100-150μm: NFZ03/2H/2M/32/5B 100-200μm: NFZ15/18 · BLE18/32</p> 	<p>NFZ5B To prevent detachment of the product, 3-point adhesive application is recommended.</p>  <p>● Adhesive application position</p> <p>Amount of adhesive applied is a standard 1/2 to 2/3 of the bottom flange thickness.</p>  <p>The bottom flange</p>

Continued on the following page. ↗

Application Specified Noise Filter (NFZ_S/NFZ_B/BLF/BLE) Soldering and Mounting

Continued from the preceding page. ↘

3. Standard Soldering Conditions

(1) Soldering Methods

Use flow and reflow soldering methods only.
 Use standard soldering conditions when soldering chip ferrite beads and bead inductors.
 In cases where several different parts are soldered, each having different soldering conditions, use those conditions requiring the least heat and minimum time.

Flux:

- Use rosin-based flux.
 In case of using RA type solder, products should be cleaned completely with no residual flux.
- Do not use strong acidic flux (with chlorine content exceeding 0.20wt%)
- Do not use water-soluble flux.

Solder: Use Sn-3.0Ag-0.5Cu solder. Use of Sn-Zn based solder will deteriorate performance of products.
 If using BLA series with Sn-Zn based solder, please contact Murata in advance.

For additional mounting methods, please contact Murata.

(2) Soldering Profile

● Flow Soldering Profile (Sn-3.0Ag-0.5Cu Solder)

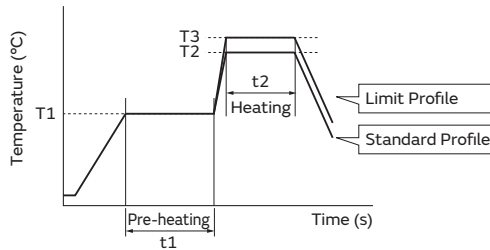

Series	Pre-heating		Standard Profile			Limit Profile		
	Temp. (T1)	Time (t1)	Temp. (T2)	Time (t2)	Cycle of Flow	Temp. (T3)	Time (t2)	Cycle of Flow
NFZ (except for NFZ03/15/18/2M/32SW)	150°C	60s min.	250°C	4 to 6s	2 times max.	265±3°C	5s max.	2 times max.
BLE								1 time *1

*1 NFZ5B/32BW

● Reflow Soldering Profile (Sn-3.0Ag-0.5Cu Solder)

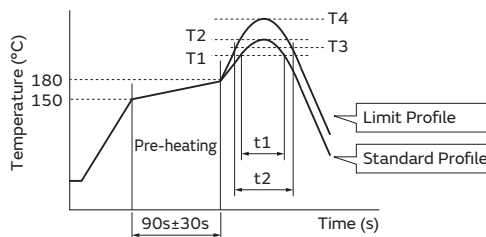

Series	Standard Profile				Limit Profile			
	Heating		Peak Temperature (T2)	Cycle of Reflow	Heating		Peak Temperature (T4)	Cycle of Reflow
Temp. (T1)	Time (t1)	Temp. (T3)			Time (t2)			
NFZ BLF02/03 BLE	220°C min.	30 to 60s	245±3°C	2 times max.	230°C min.	60s max.	260°C/10s	2 times max.

Continued on the following page. ↗

Application Specified Noise Filter (NFZ_S/NFZ_B/BLF/BLE) Soldering and Mounting

Continued from the preceding page. ↘

(3) Reworking with a soldering Iron

The following conditions must be strictly followed when using a soldering iron (except for NFZ03 · BLF02).

Pre-heating: 150°C 60s min.

Soldering iron power output / Tip diameter:

80W max. / ø3mm max.

Temperature of soldering iron tip / Soldering time / Times:

350°C max. / 3-4s / 2 times

Do not allow the tip of the soldering iron to directly contact the chip.

For additional methods of reworking with a soldering iron, please contact Murata engineering.

4. Cleaning

The following conditions should be observed when cleaning chip ferrite beads.

(1) Cleaning temperature: 60°C max. (40°C max. for alcohol type cleaner)

(2) Ultrasonic

Output: 20W/liter max.

Duration: 5 minutes max.

Frequency: 28 to 40kHz

(3) Cleaning Agent

The following cleaning agents have been tested on the individual components. Evaluation of final assembly should be completed prior to production.

(a) Alcohol cleaning agent

Isopropyl alcohol (IPA)

(b) Aqueous cleaning agent

Pine Alpha ST-100S (except for NFZ5B)

(4) Ensure that flux residue is completely removed.

The component should be thoroughly dried after the aqueous agent has been removed with deionized water.

Inductor for Audio Line Noise Suppression (LQW_CA) Soldering and Mounting

1. Standard Land Pattern Dimensions

A high Q value is achieved when the PCB electrode land pattern is designed so that it does not project beyond the chip inductor's (chip coil's) electrode.

Land Pattern + Solder Resist
 Land Pattern
 Solder Resist
 (in mm)

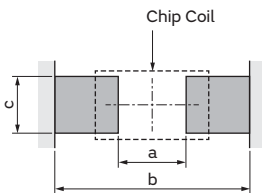
Series	Standard Land Dimensions						
LQW04CA LQW15CA LQW18CA				Part Number	a	b	c
LQW04CA	0.45	1.05	0.48	LQW04CA	0.45	1.45	0.64
LQW15CA	0.45	1.45	0.64	LQW18CA	0.7	2.2	1.0

Attention should be paid to potential magnetic coupling effects when using the Inductor (coil) as a resonator.

2. Standard Soldering Conditions

(1) Soldering method

Please use reflow soldering.

Solder: Use Sn-3.0Ag-0.5Cu solder.

Flux: Use rosin-based flux, but not strongly acidic flux (with chlorine content exceeding 0.2wt%).

Do not use water-soluble flux.

The flux used for the LQW04CA/15CA/18CA series should be a rosin-based flux that includes a middle activator equivalent to 0.06wt% to 0.1wt% chlorine.

For additional mounting methods, please contact Murata.

(2) Soldering profile

● Reflow Soldering profile (Sn-3.0Ag-0.5Cu solder)

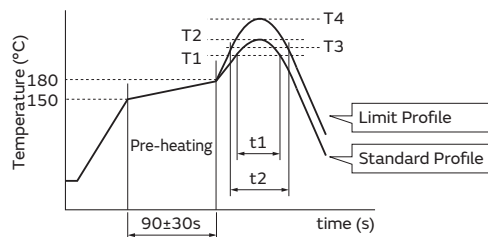

Series	Standard Profile				Limit Profile			
	Heating		Peak temperature (T2)	Cycle of reflow	Heating		Peak temperature (T4)	Cycle of reflow
	Temp. (T1)	Time (t1)			Temp. (T3)	Time (t2)		
LQW04CA/15CA/18CA	220°C	30 to 60s	245±3°C	2 times max.	230°C	60s max.	260°C/10s	2 times max.

(3) Reworking with a Soldering Iron (except for LQW04C)

Preheating at 150°C for 1 minute is required. Do not directly touch the ceramic element with the tip of the soldering iron. The reworking soldering conditions are as follows:

Soldering iron power output: 80W max.

Temperature of soldering iron tip: 350°C

Diameter of soldering iron end: 3.0mm max.

Soldering time: within 3s

Please keep the fix time with the soldering iron within 2 times.

Continued on the following page. ↗

Inductor for Audio Line Noise Suppression (LQW_CA) Soldering and Mounting

Continued from the preceding page. ↘

3. Mounting Instructions

(1) Land Pattern Designing (LQW_C series)

Please follow the recommended patterns.
Otherwise, their performance, which includes electrical performance or solderability, may be affected, or result in “position shift” in the soldering process.

(2) Magnetic Coupling

Since some chip inductors (chip coils) are constructed like an open magnetic circuit, narrow spacing between inductors (coils) may cause magnetic coupling.

(3) PCB Warping

The PCB should be designed so that products are not subjected to mechanical stress caused by warping the board.

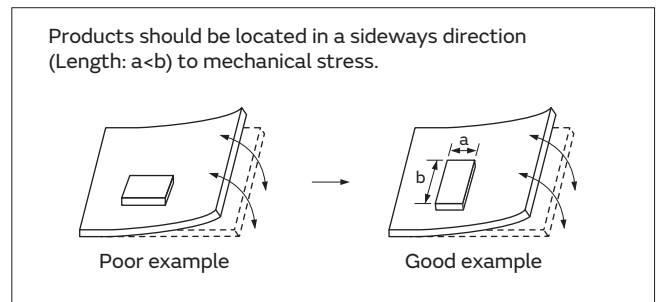

(4) Amount of Solder Paste

Excessive solder causes electrode corrosion, while insufficient solder causes low electrode bonding strength. Adjust the amount of solder paste as shown on the right so that the correct amount is applied.

Guideline of solder paste thickness

- LQW15C: 50 to 100 μ m
- LQW04C: 80 to 100 μ m
- LQW18C: 100 to 150 μ m

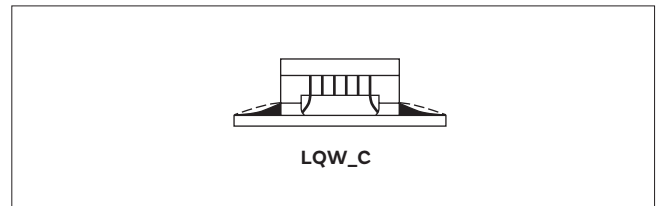

Continued on the following page. ↗

4. Cleaning

The following conditions should be observed when cleaning chip inductors (chip coils):

- (1) Cleaning temperature: 60°C max. (40°C max. for alcohol cleaning agents)
- (2) Ultrasonic
Output: 20W/l max.
Duration: 5 minutes max.
Frequency: 28 to 40kHz
Care should be taken not to cause resonance of the PCB and mounted products.
- (3) Cleaning agent
The following cleaning agents have been tested on individual components. Evaluation in complete assembly should be done prior to production.
 - (a) Alcohol cleaning agents
Isopropyl alcohol (IPA)
 - (b) Aqueous cleaning agents
Pine Alpha ST-100S

- (4) Ensure that flux residue is completely removed.
The component should be thoroughly dried after the aqueous agents have been removed with deionized water.

For additional cleaning methods, please contact Murata.

Application Specified Noise Filter (NFZ_S/NFZ_B/BLF/BLE) Packaging

Minimum Quantity and Dimensions of 8mm Width Paper / Embossed Tape

(Paper Tape)

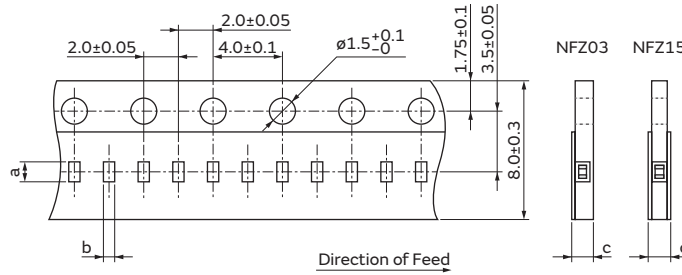

Part Number	Dimensions			Minimum Qty. (pcs.)		
	a	b	c	ø180mm Reel	ø330mm Reel	Bulk
NFZ03	0.66	0.36	0.55 max.	15000	-	1000
NFZ15	1.15	0.65	0.8 max.	10000	-	1000

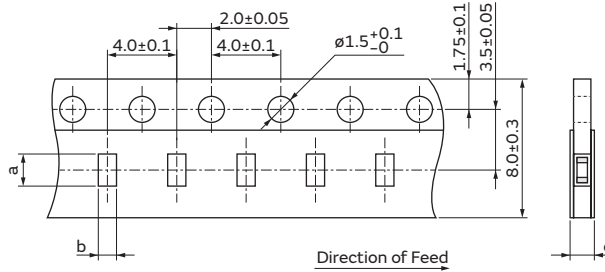

Dimension of the cavity is measured at the bottom side.

Part Number	Dimensions			Minimum Qty. (pcs.)		
	a	b	c	ø180mm Reel	ø330mm Reel	Bulk
NFZ18	1.85	1.05	1.1 max.	4000	-	1000
BLE18	1.85	1.05	0.85 max.	4000	10000	1000

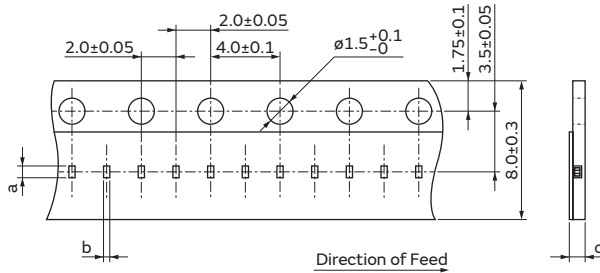

Part Number	Dimensions			Minimum Qty. (pcs.)		
	a	b	c	ø180mm Reel	ø330mm Reel	Bulk
BLF02	0.45	0.25	0.52 max.	15000	-	1000
BLF03	0.68	0.36	0.65 max.	15000	-	1000

(in mm)

Continued on the following page. ↗

"Minimum Quantity" means the number of units of each delivery or order. The quantity should be an integral multiple of the "Minimum Quantity."

Application Specified Noise Filter (NFZ_S/NFZ_B/BLF/BLE) Packaging

Continued from the preceding page. ↘

Minimum Quantity and Dimensions of 8mm Width Paper / Embossed Tape

(Embossed Tape)

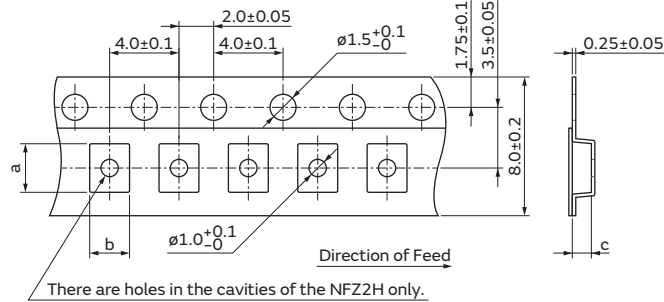

Dimension of the cavity is measured at the bottom side.

Part Number	Dimensions			Minimum Qty. (pcs.)		
	a	b	c	ø180mm Reel	ø330mm Reel	Bulk
NFZ2H	2.8	2.3	1.1	3000	-	1000
NFZ2M	2.4	1.9	1.1	3000	-	1000

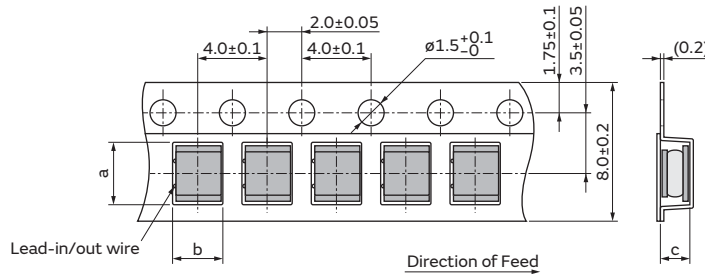

Dimension of the cavity is measured at the bottom side.

Part Number	Dimensions			Minimum Qty. (pcs.)		
	a	b	c	ø180mm Reel	ø330mm Reel	Bulk
NFZ32	3.6	2.9	1.7	2000	7500	-

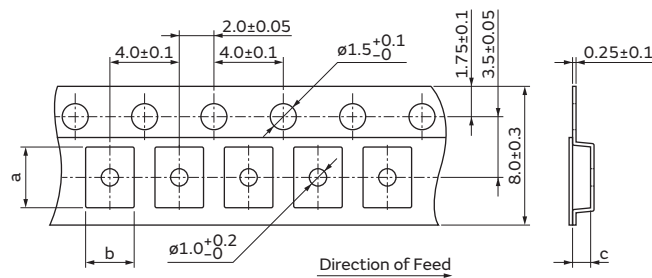

Dimension of the cavity is measured at the bottom side.

Part Number	Dimensions			Minimum Qty. (pcs.)		
	a	b	c	ø180mm Reel	ø330mm Reel	Bulk
BLE32PN260SN1	3.5	2.8	1.75	1500	7000	1000
BLE32PN300SN1			2.3			

(in mm)

Continued on the following page. ↗

"Minimum Quantity" means the number of units of each delivery or order. The quantity should be an integral multiple of the "Minimum Quantity."

Application Specified Noise Filter (NFZ_S/NFZ_B/BLF/BLE) Packaging

Continued from the preceding page. ↘

Minimum Quantity and Dimensions of 12mm Width Embossed Tape

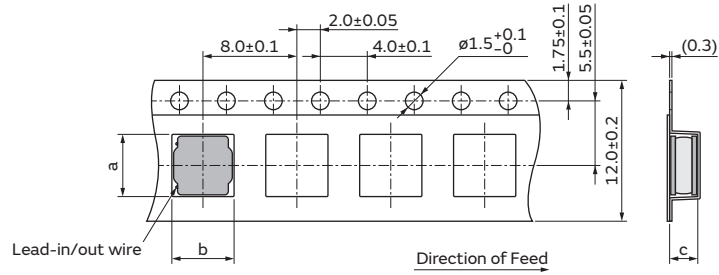

Dimension of the cavity is measured at the bottom side.

Part Number	Dimensions			Minimum Qty. (pcs.)		
	a	b	c	ø180mm Reel	ø330mm Reel	Bulk
NFZ5B	5.3	5.3	2.4	500	3000	-

(in mm)

"Minimum Quantity" means the number of units of each delivery or order. The quantity should be an integral multiple of the "Minimum Quantity."

Inductor for Audio Line Noise Suppression (LQW_CA) Packaging

Minimum Quantity and 8mm Width Taping Dimensions

(Paper Tape)

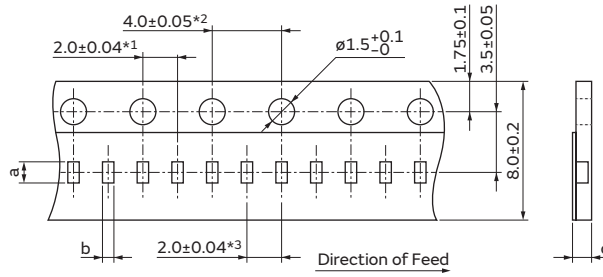

- *1 LQW15C: 2.0 ± 0.05
- *2 LQW15C: 4.0 ± 0.1
- *3 LQW15C: 2.0 ± 0.05

Part Number	Dimensions		Total Thickness of Tape c	Packaging Code (Minimum Qty. (pcs.))		
	a	b		ϕ180mm Reel	ϕ330mm Reel	Bulk
LQW04C	1.01	0.59	0.71 max.	10000	-	500
LQW15C	1.22	0.66	0.9 max.	10000	-	500

(in mm)

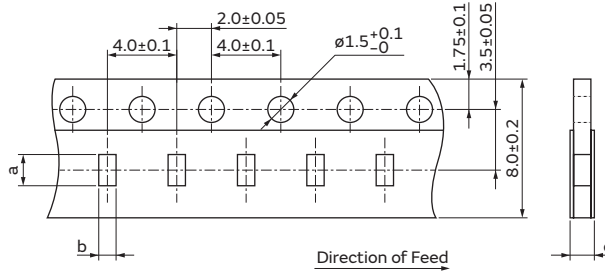

Part Number	Dimensions		Total Thickness of Tape c	Packaging Code (Minimum Qty. (pcs.))		
	a	b		ϕ180mm Reel	ϕ330mm Reel	Bulk
LQW18C	1.8	1.0	1.1 max.	4000	10000	500

(in mm)

Chip EMIFIL® NFL/NFA/NFW/NFE Series

Series Introduction	p166
Part Numbering	p168
Series Lineup	p170
Product Detail	p172
⚠Caution/Notice	p185
Soldering and Mounting	p186
Packaging	p190

Chip EMIFIL® (NF□) Series Introduction

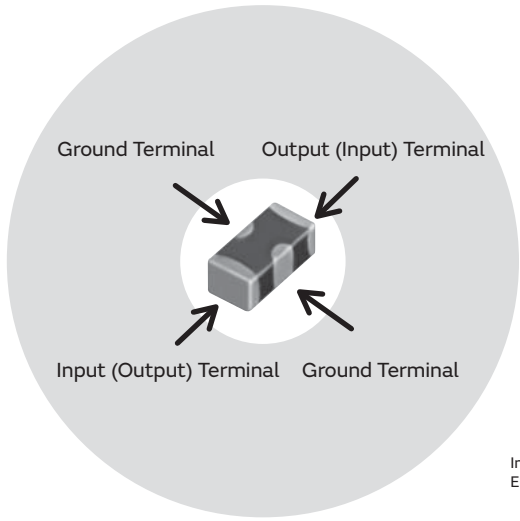

Example of 3-Terminal Capacitor Structure

Chip 3-terminal capacitor is a chip-shaped 3-terminal capacitor designed for noise suppression. Its inner structure, like a feed-through capacitor, makes its ground impedance quite low. Owing to this structure, the 3-terminal capacitor has a good noise suppression effect at a high frequency range up to several hundred MHz.

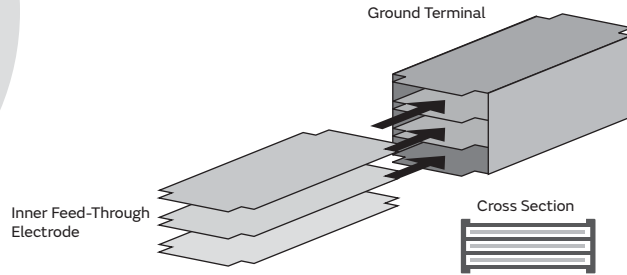

Series	Equivalent Circuit	Part Number	
NFM Series (3-terminal capacitor)		NFM18CC	
		NFM21CC	
		NFM18PC	
		NFM18PS	
		NFM21PC	
NFL / NFW / NFA Series (LC filter)		NFL18ST	
		NFL18SP	
		NFL21SP NFW31SP	
		NFA21SL	
		NFA18SL	
		NFA18SD	
NFE Series (Feed-through capacitor with ferrite cores)		NFE31PT NFE61PT	

Chip EMIFIL® (NF□) Series Introduction

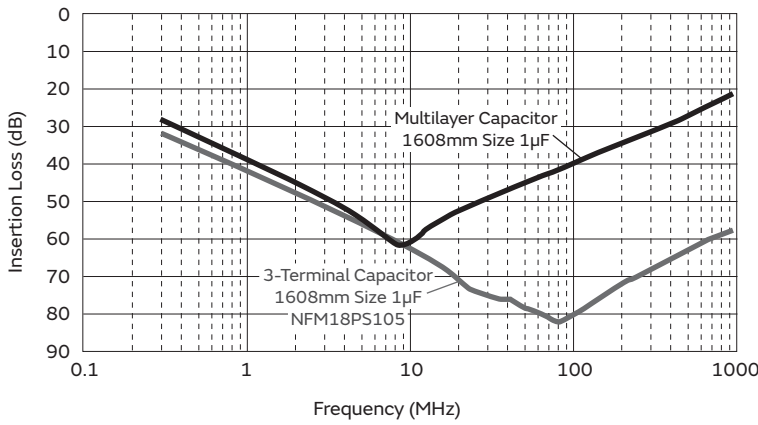

Insertion Loss Sample	Features	Classification		Applications	Example
		Code	Description		
	Standard of 3-terminal capacitor	NFM_CC	Standard type with varied capacitance	Noise suppression in low speed signal lines	· Low speed interface lines · Sensor
		NFM_PC	Meet large current, high capacitance available, for power lines	Noise suppression in power lines	· Individual IC power lines
	Sharp insertion loss curve enables low damage to signal waveform	NFL_ST	T-type filter, effective in low impedance circuits	Noise suppression in high-speed signal lines	· High-speed interface lines · Bus lines · LCD lines · Camera I/Fs · High-speed analog lines · RGB / D terminal
		NFL_SP	π-type filter, effective in high impedance circuits		
		NFW_SP	π-type filter, designed for low impedance circuits		
	Meets large current, good high frequency performance because of its feed-through structure	NFA_SL	4-line array, suitable for bus lines or flat cables	Noise suppression in power lines / low impedance lines	· Various power lines · Sensor

Chip Ferrite Bead

Application Specified Noise Filter

Chip EMIFIL®

Common Mode Choke Coil
 · Common Mode Noise Filter

Block Type EMIFIL®

EMC Absorber

● Part Numbering

Chip EMIFIL® LC Combined (1)

(Part Number)

NF	L	18	ST	107	X	1C	3	L
①	②	③	④	⑤	⑥	⑦	⑧	⑨

① Product ID

Product ID	
NF	Chip EMIFIL®

② Structure

Code	Structure
W	Wire Wound, LC Combined Type
L	Multilayer, LC Combined Type
E	Block, LC Combined Type

③ Dimensions (LxW)

Code	Dimensions (LxW)	Size Code (inch)
15	1.0x0.5mm	0402
18	1.6x0.8mm	0603
21	2.0x1.25mm	0805
31	3.2x1.6mm	1206
61	6.8x1.6mm	2706

④ Features

Code	Features	
SP		For Signal Lines, π Circuit
ST	For General-Purpose	For Signal Lines, T Circuit
PT		For Large Current, T Circuit

⑤ Cut-off Frequency (NFL/NFW Series)

Expressed by three figures. The unit is in hertz (Hz). The first and second figures are significant digits, and the third figure expresses the number of zeros that follow the two figures.

⑥ Capacitance (NFE Series)

Expressed by three figures. The unit is in pico-farad (pF). The first and second figures are significant digits, and the third figure expresses the number of zeros that follow the two figures.

⑥ Characteristics (NFL/NFW Series)

Code	Characteristics
H/X	Cut-off Frequency

⑥ Characteristics (NFE Series)

Code	Capacitance Temperature Characteristics
B	$\pm 10\%$
C	$\pm 20\%$, $\pm 22\%$
D	$+20/-30\%$, $+22/-33\%$
E	$+20/-55\%$, $+22/-56\%$
F	$+30/-80\%$, $+22/-82\%$
R	$\pm 15\%$
U	$-750 \pm 120\text{ppm}/^\circ\text{C}$
Z	Other

⑦ Rated Voltage

Code	Rated Voltage
1A	10V
1C	16V
1E	25V
1H	50V
2A	100V

⑧ Electrode

Code	Electrode	Series
3/7	Sn Plating	NFL
4	Lead-Free Solder Coating	NFW
9	Others	NFE

⑨ Packaging

Code	Packaging
K	Embossed Taping ($\phi 330\text{mm}$ Reel)
L	Embossed Taping ($\phi 180\text{mm}$ Reel)
B	Bulk
D	Paper Taping ($\phi 180\text{mm}$ Reel)

Chip EMIFIL® LC Combined (2)

(Part Number)

NF	A	21	SL	207	X	1A	4	5	L
1	2	3	4	5	6	7	8	9	10

① Product ID

Product ID	Features
NF	Chip EMIFIL®

② Structure

Code	Structure
A	Array Type

③ Dimensions (L x W)

Code	Dimensions (LxW)	Size Code (inch)
18	1.6x0.8mm	0603
21	2.0x1.25mm	0805

④ Features (1)

Code	Features
SL	L Circuit for Signal Lines
SD	L Circuit for Differential Signal

⑤ Cut-off Frequency

Expressed by three figures. The unit is in hertz (Hz). The first and second figures are significant digits, and the third figure expresses the number of zeros that follow the two figures.

⑥ Features (2)

Code	Features
X	Expressed by a letter
V	

⑦ Rated Voltage

Code	Rated Voltage
1A	10V

⑧ Number of Circuits

Code	Number of Circuits
4	4 Circuits

⑨ Dimensions (T)

Code	Dimensions (T)
5	Low Profile
8	Standard

⑩ Packaging

Code	Packaging
B	Bulk
L	Embossed Taping (ø180mm Reel)

Series Lineup

NFL/NFA/NFW/NFE

Chip EMIFIL®

Type	Size Code in inches (mm)	Thickness (mm)	Part Number	Rated Voltage	Capacitance	Nominal Cut-off Frequency	Rated Current
LC Combined Type for Power Lines and Signal Lines	1206 (3216)	1.6	NFE31PT220R1E9 ^{p172}	25Vdc	22pF±30%	-	6A
		1.6	NFE31PT470C1E9 ^{p172}	25Vdc	47pF 50/-20%	-	6A
		1.6	NFE31PT101C1E9 ^{p172}	25Vdc	100pF 80/-20%	-	6A
		1.6	NFE31PT221D1E9 ^{p172}	25Vdc	220pF 50/-20%	-	6A
		1.6	NFE31PT471F1E9 ^{p172}	25Vdc	470pF 50/-20%	-	6A
		1.6	NFE31PT152Z1E9 ^{p172}	25Vdc	1500pF 50/-20%	-	6A
		1.6	NFE31PT222Z1E9 ^{p172}	25Vdc	2200pF±50%	-	6A
	2706 (6816)	1.6	NFE61PT330B1H9 ^{p173}	50Vdc	33pF±30%	-	2A
		1.6	NFE61PT680B1H9 ^{p173}	50Vdc	68pF±30%	-	2A
		1.6	NFE61PT101Z1H9 ^{p173}	50Vdc	100pF±30%	-	2A
		1.6	NFE61PT181B1H9 ^{p173}	50Vdc	180pF±30%	-	2A
		1.6	NFE61PT361B1H9 ^{p173}	50Vdc	360pF±20%	-	2A
		1.6	NFE61PT681B1H9 ^{p173}	50Vdc	680pF±30%	-	2A
		1.6	NFE61PT102E1H9 ^{p173}	50Vdc	1000pF 80/-20%	-	2A
LC Combined Multilayer Type for Signal Lines	0603 (1608)	0.6	NFL18ST506H1A3 ^{p174}	10Vdc	110pF (Typ.)	50MHz	75mA
		0.6	NFL18ST706H1A3 ^{p174}	10Vdc	70pF (Typ.)	70MHz	75mA
		0.6	NFL18ST107H1A3 ^{p174}	10Vdc	50pF (Typ.)	100MHz	75mA
		0.6	NFL18ST207H1A3 ^{p174}	10Vdc	22pF (Typ.)	200MHz	100mA
		0.6	NFL18ST307H1A3 ^{p174}	10Vdc	16pF (Typ.)	300MHz	100mA
		0.6	NFL18ST507H1A3 ^{p174}	10Vdc	10pF (Typ.)	500MHz	100mA
		0.8	NFL18ST207X1C3 ^{p175}	16Vdc	25pF±20%	200MHz	150mA
		0.8	NFL18ST307X1C3 ^{p175}	16Vdc	18pF±20%	300MHz	200mA
		0.8	NFL18ST507X1C3 ^{p175}	16Vdc	10pF±20%	500MHz	200mA
		0.6	NFL18SP157X1A3 ^{p176}	10Vdc	34pF±20%	150MHz	100mA
	0805 (2012)	0.6	NFL18SP207X1A3 ^{p176}	10Vdc	24pF±20%	200MHz	100mA
		0.6	NFL18SP307X1A3 ^{p176}	10Vdc	19pF±20%	300MHz	100mA
		0.6	NFL18SP507X1A3 ^{p176}	10Vdc	11pF±20%	500MHz	100mA
		0.85	NFL21SP106X1C3 ^{p177}	16Vdc	670pF±20%	10MHz	100mA
		0.85	NFL21SP206X1C7 ^{p177}	16Vdc	240pF±20%	20MHz	100mA
		0.85	NFL21SP506X1C3 ^{p177}	16Vdc	84pF±20%	50MHz	150mA
		0.85	NFL21SP706X1C3 ^{p177}	16Vdc	76pF±20%	70MHz	150mA
		0.85	NFL21SP107X1C3 ^{p177}	16Vdc	44pF±20%	100MHz	200mA
		0.85	NFL21SP157X1C3 ^{p177}	16Vdc	28pF±20%	150MHz	200mA
		0.85	NFL21SP207X1C3 ^{p177}	16Vdc	22pF±20%	200MHz	250mA
LC Combined Array Type for Signal Lines	0603 (1608)	0.6	NFA18SL137V1A45 ^{p179}	10Vdc	-	130MHz	50mA
		0.6	NFA18SL187V1A45 ^{p179}	10Vdc	-	180MHz	50mA
		0.6	NFA18SL207V1A45 ^{p179}	10Vdc	-	200MHz	50mA
		0.6	NFA18SL227V1A45 ^{p179}	10Vdc	-	220MHz	25mA
		0.5	NFA18SL307V1A45 ^{p179}	10Vdc	-	300MHz	100mA
		0.5	NFA18SL357V1A45 ^{p179}	10Vdc	-	350MHz	35mA
		0.5	NFA18SL407V1A45 ^{p179}	10Vdc	-	400MHz	100mA
		0.5	NFA18SL487V1A45 ^{p179}	10Vdc	-	480MHz	100mA
		0.6	NFA18SL506X1A45 ^{p180}	10Vdc	-	50MHz	25mA
		0.6	NFA18SD187X1A45 ^{p181}	10Vdc	-	180MHz	25mA
	0805 (2012)	0.6	NFA18SD207X1A45 ^{p181}	10Vdc	-	200MHz	25mA
		0.5	NFA21SL287V1A45 ^{p182}	10Vdc	-	280MHz	100mA
		0.5	NFA21SL317V1A45 ^{p182}	10Vdc	-	310MHz	100mA

Continued on the following page. ↗

Type	Size Code in inches (mm)	Thickness (mm)	Part Number	Rated Voltage	Capacitance	Nominal Cut-off Frequency	Rated Current
LC Combined Array Type for Signal Lines	0805 (2012)	0.5	NFA21SL337V1A45 ^{p182}	10Vdc	-	330MHz	100mA
		0.85	NFA21SL287V1A48 ^{p182}	10Vdc	-	280MHz	100mA
		0.85	NFA21SL317V1A48 ^{p182}	10Vdc	-	310MHz	100mA
		0.85	NFA21SL337V1A48 ^{p182}	10Vdc	-	330MHz	100mA
		0.5	NFA21SL207X1A45 ^{p183}	10Vdc	-	200MHz	100mA
		0.5	NFA21SL307X1A45 ^{p183}	10Vdc	-	300MHz	100mA
		0.85	NFA21SL506X1A48 ^{p183}	10Vdc	-	50MHz	20mA
		0.85	NFA21SL806X1A48 ^{p183}	10Vdc	-	80MHz	20mA
		0.85	NFA21SL207X1A48 ^{p183}	10Vdc	-	200MHz	100mA
		0.85	NFA21SL307X1A48 ^{p183}	10Vdc	-	300MHz	100mA
LC Combined Wire Wound Type for Signal Lines	1206 (3216)	1.8	NFW31SP106X1E4 ^{p184}	25Vdc	-	10MHz	200mA
		1.8	NFW31SP206X1E4 ^{p184}	25Vdc	-	20MHz	200mA
		1.8	NFW31SP506X1E4 ^{p184}	25Vdc	-	50MHz	200mA
		1.8	NFW31SP107X1E4 ^{p184}	25Vdc	-	100MHz	200mA
		1.8	NFW31SP157X1E4 ^{p184}	25Vdc	-	150MHz	200mA
		1.8	NFW31SP207X1E4 ^{p184}	25Vdc	-	200MHz	200mA
		1.8	NFW31SP307X1E4 ^{p184}	25Vdc	-	300MHz	200mA
		1.8	NFW31SP407X1E4 ^{p184}	25Vdc	-	400MHz	200mA
		1.8	NFW31SP507X1E4 ^{p184}	25Vdc	-	500MHz	200mA

Chip Ferrite Bead

Application Specified Noise Filter

Chip EMIFIL®

Common Mode Choke Coil
 Common Mode Noise Filter

Block Type EMIFIL®

EMC Absorber



NFE31PT Series 1206/3216(inch/mm)

Appearance/Dimensions

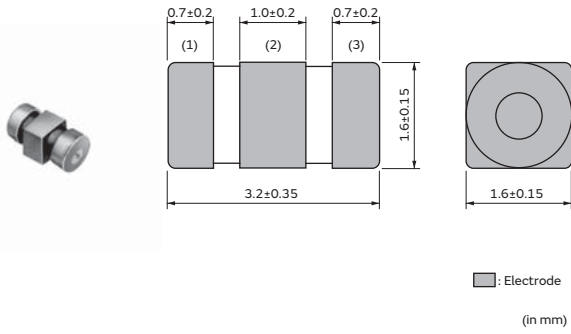

Packaging

Code	Packaging	Minimum Quantity
L	ø180mm Embossed Tape	2000
K	ø330mm Embossed Tape	8000
B	Bulk(Bag)	500

Equivalent Circuit

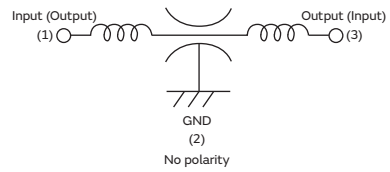

Rated Value (□: packaging code)

Part Number	Capacitance	Rated Current	Rated Voltage	Insulation Resistance (min.)	Operating Temperature Range
NFE31PT220R1E9□	22pF ±30%	6A	25Vdc	1000M ohm	-40°C to 85°C
NFE31PT470C1E9□	47pF 50/-20%	6A	25Vdc	1000M ohm	-40°C to 85°C
NFE31PT101C1E9□	100pF 80/-20%	6A	25Vdc	1000M ohm	-40°C to 85°C
NFE31PT221D1E9□	220pF 50/-20%	6A	25Vdc	1000M ohm	-40°C to 85°C
NFE31PT471F1E9□	470pF 50/-20%	6A	25Vdc	1000M ohm	-40°C to 85°C
NFE31PT152Z1E9□	1500pF 50/-20%	6A	25Vdc	1000M ohm	-40°C to 85°C
NFE31PT222Z1E9□	2200pF ±50%	6A	25Vdc	1000M ohm	-40°C to 85°C

Number of Circuit: 1

Insertion Loss Characteristics

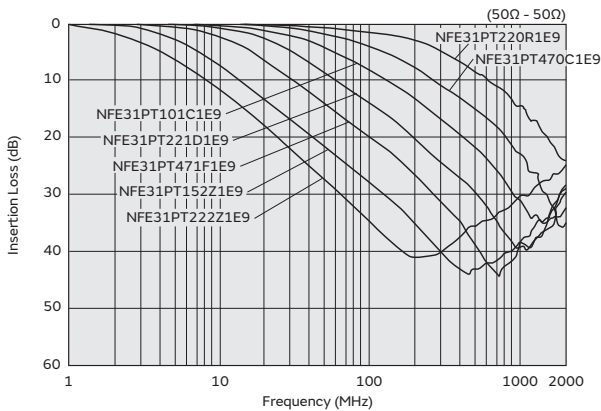

Chip Ferrite Bead

Application Specified Noise Filter

Chip EMIFIL®

Common Mode Choke Coil
Common Mode Noise Filter

Block Type EMIFIL®

EMC Absorber



NFE61PT Series 2706/6816(inch/mm)

Appearance/Dimensions

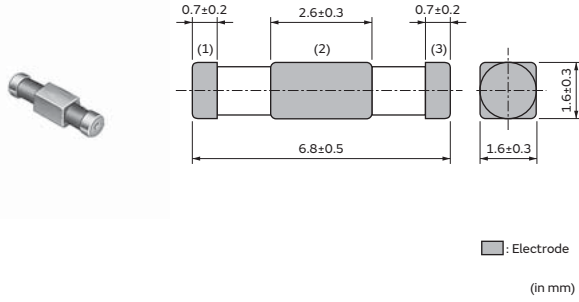

Packaging

Code	Packaging	Minimum Quantity
L	ø180mm Embossed Tape	2500
K	ø330mm Embossed Tape	8000
B	Bulk(Bag)	500

Equivalent Circuit

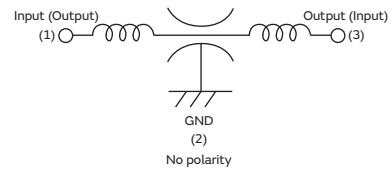

Rated Value (□: packaging code)

Part Number	Capacitance	Rated Current	Rated Voltage	Insulation Resistance (min.)	Operating Temperature Range
NFE61PT330B1H9□	33pF ±30%	2A	50Vdc	1000M ohm	-40°C to 85°C
NFE61PT680B1H9□	68pF ±30%	2A	50Vdc	1000M ohm	-40°C to 85°C
NFE61PT101Z1H9□	100pF ±30%	2A	50Vdc	1000M ohm	-40°C to 85°C
NFE61PT181B1H9□	180pF ±30%	2A	50Vdc	1000M ohm	-40°C to 85°C
NFE61PT361B1H9□	360pF ±20%	2A	50Vdc	1000M ohm	-40°C to 85°C
NFE61PT681B1H9□	680pF ±30%	2A	50Vdc	1000M ohm	-40°C to 85°C
NFE61PT102E1H9□	1000pF 80/-20%	2A	50Vdc	1000M ohm	-40°C to 85°C
NFE61PT472C1H9□	4700pF 80/-20%	2A	50Vdc	1000M ohm	-40°C to 85°C

Number of Circuit: 1

Insertion Loss Characteristics

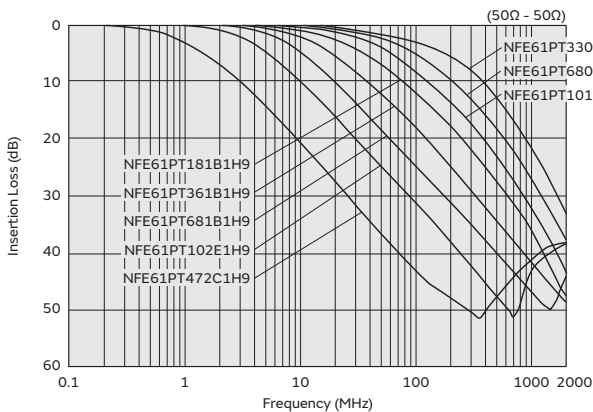

Chip EMIFIL®

NFL18ST Series 0603/1608(inch/mm)

Appearance/Dimensions

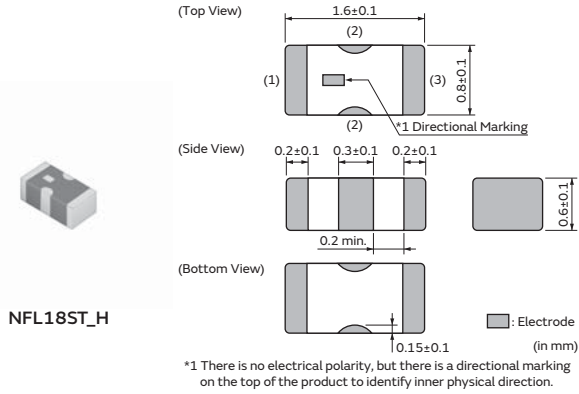

Packaging

Code	Packaging	Minimum Quantity
D	ø180mm Paper Tape	4000
B	Bulk(Bag)	1000

Equivalent Circuit

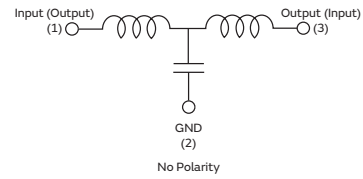

Appearance/Dimensions

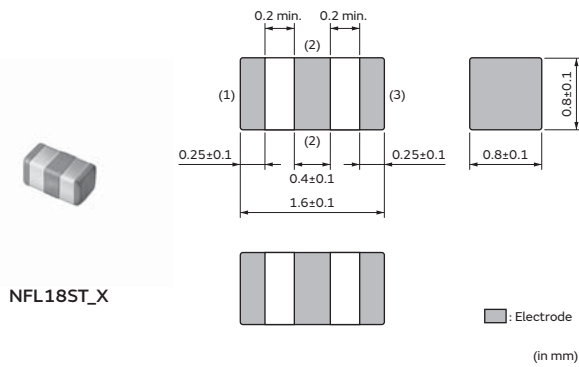

Packaging

Code	Packaging	Minimum Quantity
D	ø180mm Paper Tape	4000
B	Bulk(Bag)	1000

Equivalent Circuit

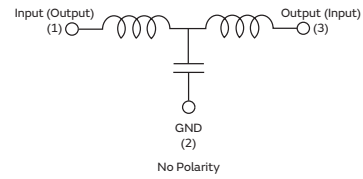

Rated Value (□: packaging code)

Part Number	Nominal Cut-off Frequency	Capacitance	Inductance	Insertion Loss 1	Insertion Loss 2	Rated Current	Rated Voltage
NFL18ST506H1A3□	50MHz	110pF (Typ.)	350nH (Typ.)	6dB max.(0 to 50MHz)	30dB min.(200 to 1000MHz)	75mA	10Vdc
NFL18ST706H1A3□	70MHz	70pF (Typ.)	230nH (Typ.)	6dB max.(0 to 70MHz)	30dB min.(300 to 1000MHz)	75mA	10Vdc
NFL18ST107H1A3□	100MHz	50pF (Typ.)	150nH (Typ.)	6dB max.(0 to 100MHz)	30dB min.(400 to 1000MHz)	75mA	10Vdc
NFL18ST207H1A3□	200MHz	22pF (Typ.)	110nH (Typ.)	6dB max.(0 to 200MHz)	30dB min.(800 to 2000MHz)	100mA	10Vdc
NFL18ST307H1A3□	300MHz	16pF (Typ.)	74nH (Typ.)	6dB max.(0 to 300MHz)	30dB min.(1200 to 2000MHz)	100mA	10Vdc
NFL18ST507H1A3□	500MHz	10pF (Typ.)	42nH (Typ.)	6dB max.(0 to 500MHz)	30dB min.(1700 to 2000MHz)	100mA	10Vdc

Insulation Resistance (min.): 1000M ohm Withstand Voltage: 30Vdc Operating Temperature Range: -55°C to 125°C Number of Circuits: 1

Continued on the following page. ↗

Chip Ferrite Bead

Application Specified Noise Filter

Chip EMIFIL®

Common Mode Choke Coil
 Common Mode Noise Filter

Block Type EMIFIL®

EMC Absorber

Continued from the preceding page. ↘

Insertion Loss Characteristics

NFL18ST_H Series

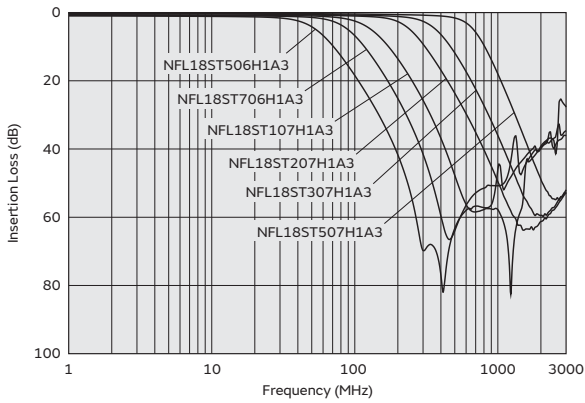

Rated Value (□: packaging code)

Part Number	Nominal Cut-off Frequency	Capacitance	Inductance	Rated Current	Rated Voltage	Insulation Resistance (min.)	Withstand Voltage	Operating Temperature Range
NFL18ST207X1C3□	200MHz	25pF±20%	110nH±20%	150mA	16Vdc	1000M ohm	50Vdc	-55°C to 125°C
NFL18ST307X1C3□	300MHz	18pF±20%	62nH±20%	200mA	16Vdc	1000M ohm	50Vdc	-55°C to 125°C
NFL18ST507X1C3□	500MHz	10pF±20%	43nH±20%	200mA	16Vdc	1000M ohm	50Vdc	-55°C to 125°C

Number of Circuits: 1

Insertion Loss Characteristics

NFL18ST_X Series

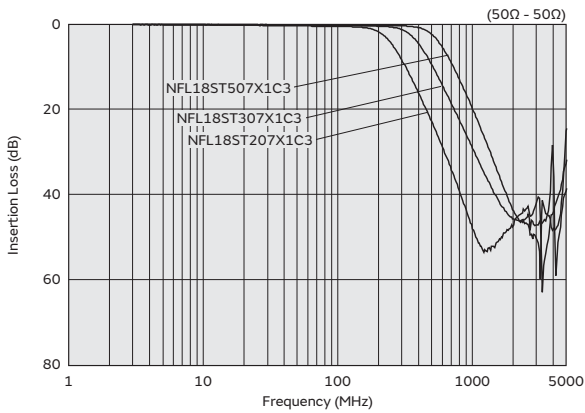

Chip Ferrite Bead

Application Specified Noise Filter

Chip EMIFIL®

Common Mode Choke Coil
 Common Mode Noise Filter

Block Type EMIFIL®

EMC Absorber



NFL18SP Series 0603/1608(inch/mm)

Appearance/Dimensions

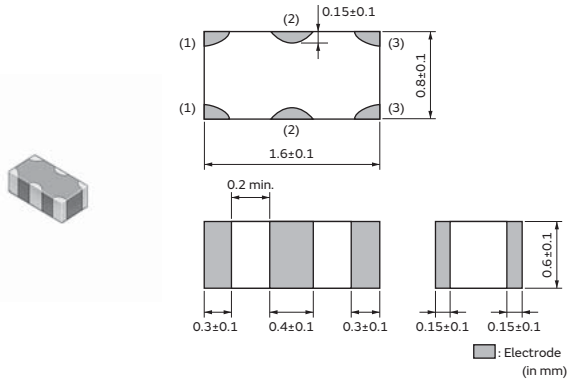

Packaging

Code	Packaging	Minimum Quantity
D	ø180mm Paper Tape	4000
B	Bulk(Bag)	1000

Equivalent Circuit

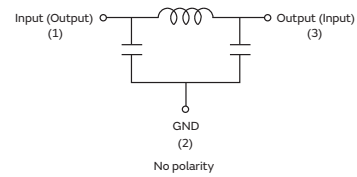

Rated Value (□: packaging code)

Part Number	Nominal Cut-off Frequency	Capacitance	Inductance	Rated Current	Rated Voltage	Insulation Resistance (min.)	Withstand Voltage	Operating Temperature Range
NFL18SP157X1A3□	150MHz	34pF±20%	100nH±20%	100mA	10Vdc	1000M ohm	30Vdc	-55°C to 125°C
NFL18SP207X1A3□	200MHz	24pF±20%	80nH±20%	100mA	10Vdc	1000M ohm	30Vdc	-55°C to 125°C
NFL18SP307X1A3□	300MHz	19pF±20%	60nH±20%	100mA	10Vdc	1000M ohm	30Vdc	-55°C to 125°C
NFL18SP507X1A3□	500MHz	11pF±20%	38nH±20%	100mA	10Vdc	1000M ohm	30Vdc	-55°C to 125°C

Number of Circuits: 1

Insertion Loss Characteristics

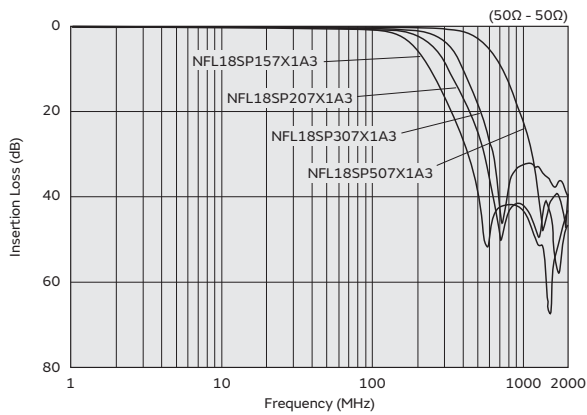



NFL21SP Series 0805/2012(inch/mm)

Appearance/Dimensions

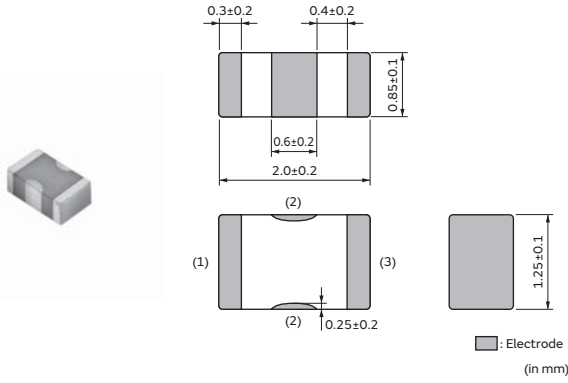

Packaging

Code	Packaging	Minimum Quantity
D	ø180mm Paper Tape	4000
B	Bulk(Bag)	1000

Equivalent Circuit

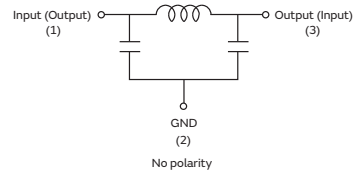

Rated Value (□: packaging code)

Part Number	Nominal Cut-off Frequency	Capacitance	Inductance	Rated Current	Rated Voltage	Insulation Resistance (min.)	Withstand Voltage	Operating Temperature Range
NFL21SP106X1C3□	10MHz	670pF±20%	680nH±20%	100mA	16Vdc	1000M ohm	50Vdc	-55°C to 125°C
NFL21SP206X1C7□	20MHz	240pF±20%	700nH±20%	100mA	16Vdc	1000M ohm	50Vdc	-55°C to 125°C
NFL21SP506X1C3□	50MHz	84pF±20%	305nH±20%	150mA	16Vdc	1000M ohm	50Vdc	-55°C to 125°C
NFL21SP706X1C3□	70MHz	76pF±20%	185nH±20%	150mA	16Vdc	1000M ohm	50Vdc	-55°C to 125°C
NFL21SP107X1C3□	100MHz	44pF±20%	135nH±20%	200mA	16Vdc	1000M ohm	50Vdc	-55°C to 125°C
NFL21SP157X1C3□	150MHz	28pF±20%	128nH±20%	200mA	16Vdc	1000M ohm	50Vdc	-55°C to 125°C
NFL21SP207X1C3□	200MHz	22pF±20%	72nH±20%	250mA	16Vdc	1000M ohm	50Vdc	-55°C to 125°C
NFL21SP307X1C3□	300MHz	19pF±10%	45nH±10%	300mA	16Vdc	1000M ohm	50Vdc	-55°C to 125°C
NFL21SP407X1C3□	400MHz	16pF±10%	34nH±10%	300mA	16Vdc	1000M ohm	50Vdc	-55°C to 125°C
NFL21SP507X1C3□	500MHz	12pF±10%	31nH±10%	300mA	16Vdc	1000M ohm	50Vdc	-55°C to 125°C

Number of Circuits: 1

Insertion Loss Characteristics

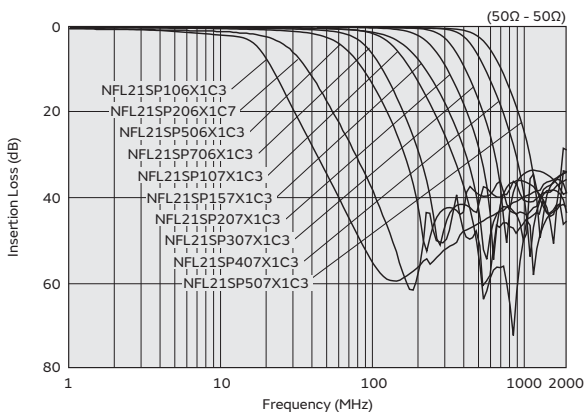

Chip EMIFIL®

NFA18SL Series 0603/1608(inch/mm)

Appearance/Dimensions

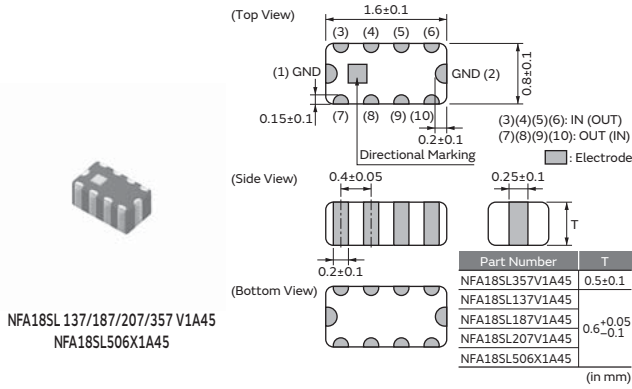

Packaging

Code	Packaging	Minimum Quantity
L	ø180mm Embossed Tape	4000
B	Bulk(Bag)	1000

Equivalent Circuit

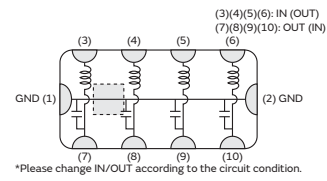

Appearance/Dimensions

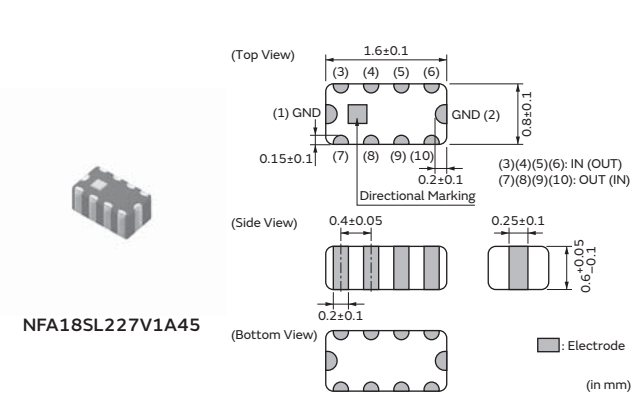

Packaging

Code	Packaging	Minimum Quantity
L	ø180mm Embossed Tape	4000
B	Bulk(Bag)	1000

Equivalent Circuit

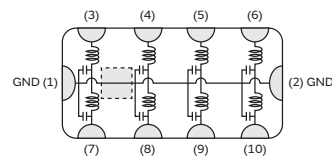

Appearance/Dimensions

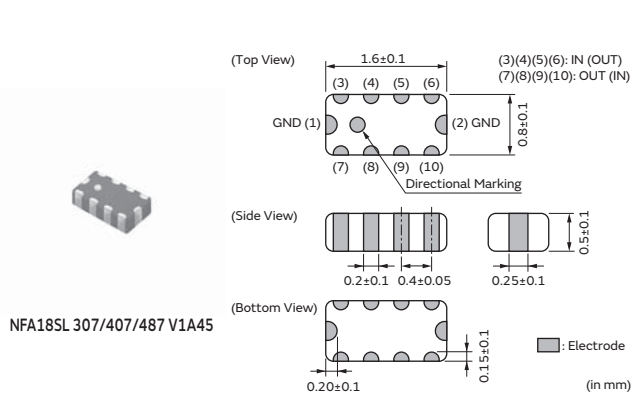

Packaging

Code	Packaging	Minimum Quantity
L	ø180mm Embossed Tape	4000
B	Bulk(Bag)	1000

Equivalent Circuit

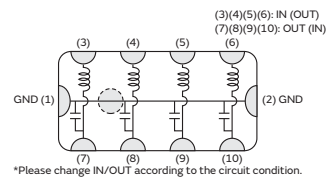

Continued on the following page. ↗

Chip Ferrite Bead

Application Specified Noise Filter

Chip EMIFIL®

Common Mode Choke Coil
 Common Mode Noise Filter

Block Type EMIFIL®

EMC Absorber

Continued from the preceding page. ↘

Rated Value (□: packaging code)

Part Number	Nominal Cut-off Frequency	Insertion Loss (Cut-off Frequency)	Insertion Loss (470MHz) (min.)	Insertion Loss (800MHz) (min.)	Insertion Loss (900MHz) (min.)	Insertion Loss (2000MHz) (min.)	Rated Current	Rated Voltage	Insulation Resistance (min.)	Withstand Voltage
NFA18SL137V1A45□	130MHz	6dB max.	25dB	-	25dB	-	50mA	10Vdc	1000M ohm	30Vdc
NFA18SL187V1A45□	180MHz	6dB max.	20dB	-	20dB	-	50mA	10Vdc	1000M ohm	30Vdc
NFA18SL207V1A45□	200MHz	6dB max.	15dB	-	15dB	-	50mA	10Vdc	1000M ohm	30Vdc
NFA18SL227V1A45□	220MHz	6dB max.	-	-	30dB	30dB	25mA	10Vdc	1000M ohm	30Vdc
NFA18SL307V1A45□	300MHz	6dB max.	-	20dB	20dB	-	100mA	10Vdc	1000M ohm	30Vdc
NFA18SL357V1A45□	350MHz	6dB max.	-	-	15dB	13dB	35mA	10Vdc	1000M ohm	30Vdc
NFA18SL407V1A45□	400MHz	6dB max.	-	18dB	18dB	-	100mA	10Vdc	1000M ohm	30Vdc
NFA18SL487V1A45□	480MHz	6dB max.	-	15dB	15dB	-	100mA	10Vdc	1000M ohm	30Vdc

Operating Temperature Range: -40°C to 85°C (NFA18SL 137/187/207/227/357 V1A45), -55°C to 125°C (NFA18SL 307/407/487 V1A45) Number of Circuits: 4

Insertion Loss Characteristics

NFA18SL 137/187/207 V1A45

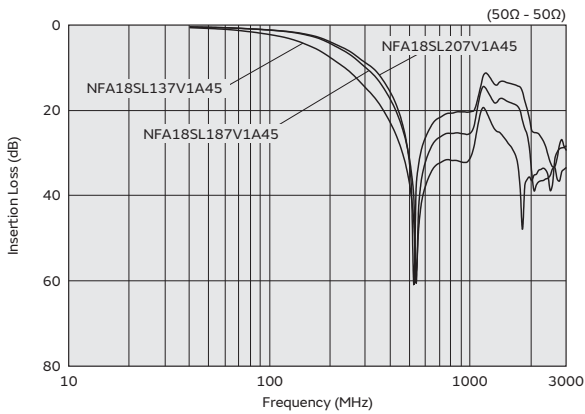

NFA18SL227V1A45

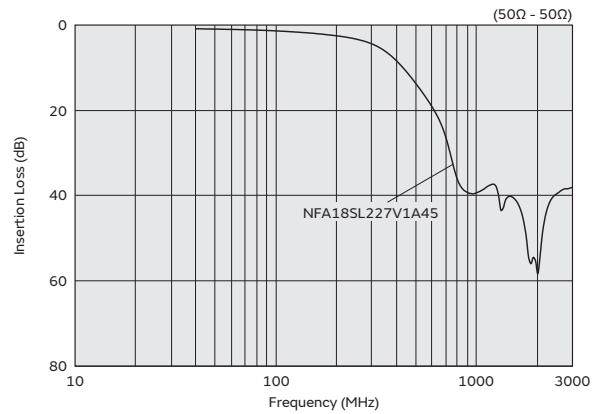

NFA18SL 307/407/487 V1A45

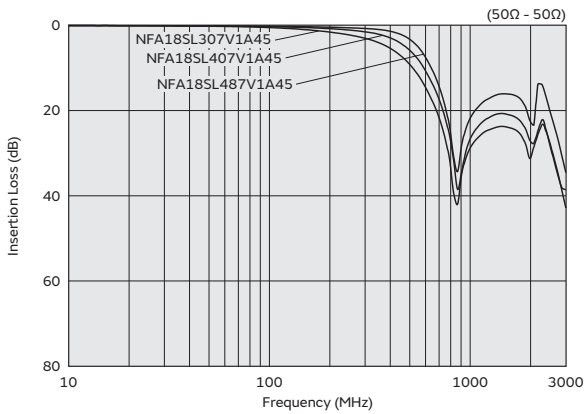

NFA18SL357V1A45

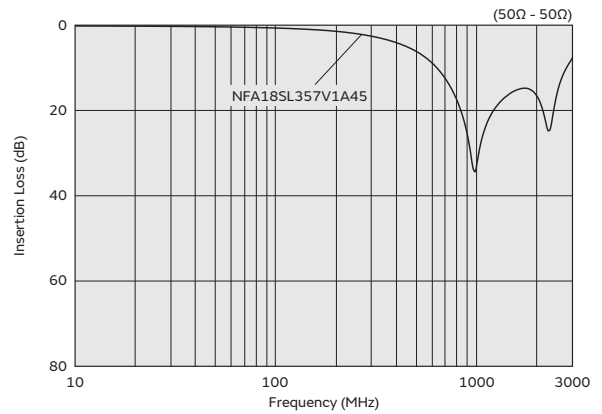

Continued on the following page. ↗

Chip Ferrite Bead

Application Specified Noise Filter

Chip EMIFIL®

Common Mode Choke Coil
 · Common Mode Noise Filter

Block Type EMIFIL®

EMC Absorber

Continued from the preceding page. ↘

Rated Value (□: packaging code)

Part Number	Nominal Cut-off Frequency	Insertion Loss (Cut-off Frequency)	Insertion Loss (500MHz) (min.)	Insertion Loss (1000MHz) (min.)	Rated Current	Rated Voltage	Insulation Resistance (min.)	Withstand Voltage
NFA18SL506X1A45□	50MHz	6dB max.	30dB	25dB	25mA	10Vdc	1000M ohm	30Vdc

Operating Temperature Range: -40°C to 85°C Number of Circuits: 4

Insertion Loss Characteristics

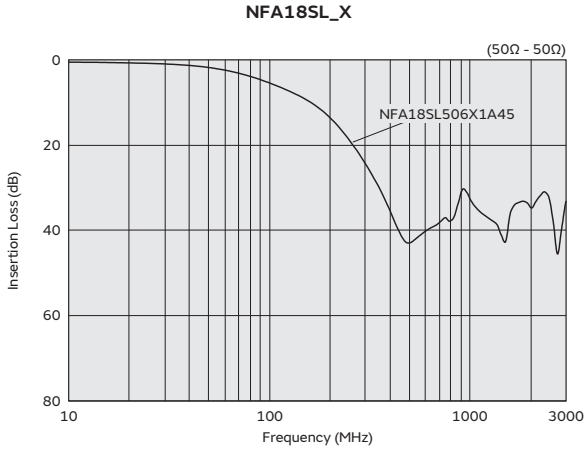



NFA18SD Series 0603/1608(inch/mm)

Appearance/Dimensions

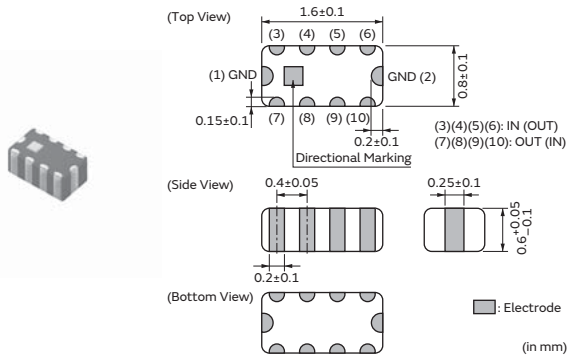

Packaging

Code	Packaging	Minimum Quantity
L	ø180mm Embossed Tape	4000
B	Bulk(Bag)	1000

Equivalent Circuit

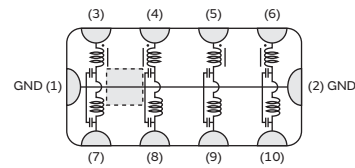

Rated Value (□: packaging code)

Part Number	Nominal Cut-off Frequency	Insertion Loss (Cut-off Frequency)	Insertion Loss (500MHz) (min.)	Insertion Loss (900MHz) (min.)	Insertion Loss (1500MHz) (min.)	Insertion Loss (2000MHz) (min.)	Rated Current	Rated Voltage	Insulation Resistance (min.)	Withstand Voltage
NFA18SD187X1A45□	180MHz	6dB max.	15dB	20dB	20dB	20dB	25mA	10Vdc	1000M ohm	30Vdc
NFA18SD207X1A45□	200MHz	6dB max.	13dB	20dB	20dB	20dB	25mA	10Vdc	1000M ohm	30Vdc

Operating Temperature Range: -40°C to 85°C Number of Circuits: 4

Insertion Loss Characteristics

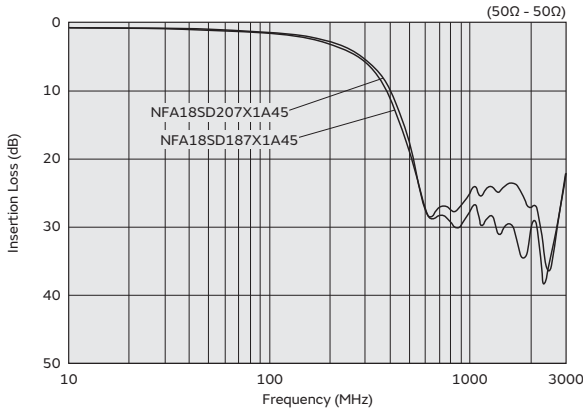



NFA21SL Series 0805/2012(inch/mm)

Appearance/Dimensions

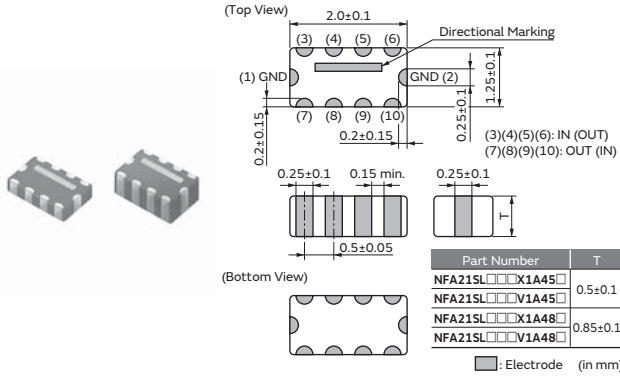

Packaging

Code	Packaging	Minimum Quantity
L	ø180mm Embossed Tape	4000
B	Bulk(Bag)	1000

Equivalent Circuit

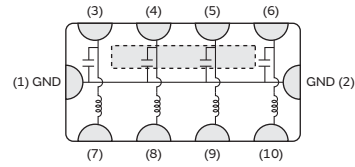

Rated Value (□: packaging code)

Part Number	Nominal Cut-off Frequency	Insertion Loss (Cut-off Frequency)	Insertion Loss (800MHz) (min.)	Insertion Loss (900MHz) (min.)	Rated Current	Rated Voltage	Insulation Resistance (min.)	Withstand Voltage
NFA21SL287V1A45□	280MHz	6dB max.	25dB	25dB	100mA	10Vdc	1000M ohm	30Vdc
NFA21SL317V1A45□	310MHz	6dB max.	20dB	20dB	100mA	10Vdc	1000M ohm	30Vdc
NFA21SL337V1A45□	330MHz	6dB max.	15dB	15dB	100mA	10Vdc	1000M ohm	30Vdc
NFA21SL287V1A48□	280MHz	6dB max.	25dB	25dB	100mA	10Vdc	1000M ohm	30Vdc
NFA21SL317V1A48□	310MHz	6dB max.	20dB	20dB	100mA	10Vdc	1000M ohm	30Vdc
NFA21SL337V1A48□	330MHz	6dB max.	20dB	20dB	100mA	10Vdc	1000M ohm	30Vdc

Operating Temperature Range: -55°C to 125°C Number of Circuits: 4

Insertion Loss Characteristics

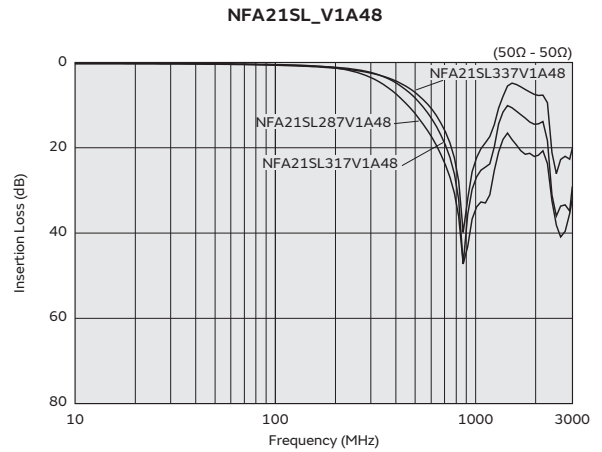
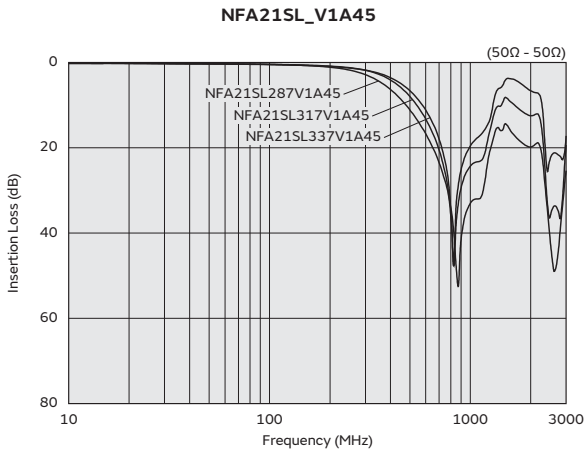

Continued on the following page. ↗

Continued from the preceding page. ↘

Rated Value (□: packaging code)

Part Number	Nominal Cut-off Frequency	Insertion Loss (Cut-off Frequency)	Insertion Loss (500MHz) (min.)	Insertion Loss (800MHz) (min.)	Insertion Loss (1000MHz) (min.)	Rated Current	Rated Voltage	Insulation Resistance (min.)	Withstand Voltage
NFA21SL207X1A45□	200MHz	2dB to 7dB	13dB	25dB	25dB	100mA	10Vdc	1000M ohm	30Vdc
NFA21SL307X1A45□	300MHz	2dB to 7dB	7dB	20dB	25dB	100mA	10Vdc	1000M ohm	30Vdc
NFA21SL506X1A48□	50MHz	0dB to 6dB	30dB	-	20dB	20mA	10Vdc	1000M ohm	30Vdc
NFA21SL806X1A48□	80MHz	2dB to 7dB	25dB	-	25dB	20mA	10Vdc	1000M ohm	30Vdc
NFA21SL207X1A48□	200MHz	2dB to 7dB	13dB	25dB	25dB	100mA	10Vdc	1000M ohm	30Vdc
NFA21SL307X1A48□	300MHz	2dB to 7dB	7dB	20dB	25dB	100mA	10Vdc	1000M ohm	30Vdc

Operating Temperature Range: -55°C to 125°C Number of Circuits: 4

Insertion Loss Characteristics

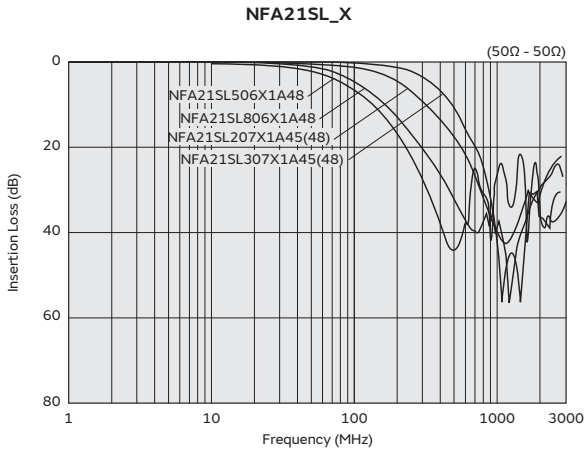

Chip Ferrite Bead

Application Specified Noise Filter

Chip EMIFIL®

Common Mode Choke Coil
 Common Mode Noise Filter

Block Type EMIFIL®

EMC Absorber



NFW31SP Series 1206/3216(inch/mm)

Appearance/Dimensions

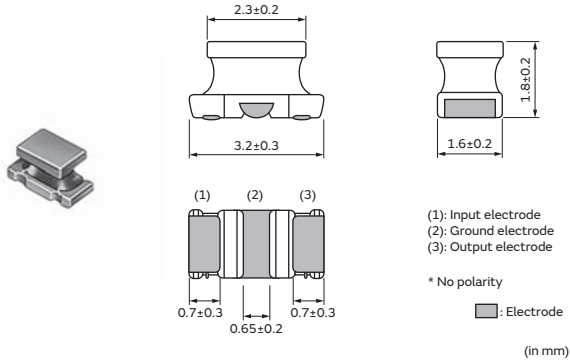

Packaging

Code	Packaging	Minimum Quantity
L	ø180mm Embossed Tape	2000
K	ø330mm Embossed Tape	7500

Equivalent Circuit

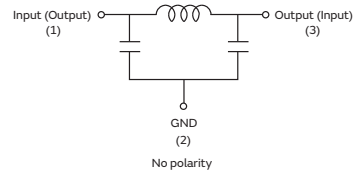

Rated Value (□: packaging code)

Part Number	Nominal Cut-off Frequency	Insertion Loss at 10MHz	Insertion Loss at 20MHz	Insertion Loss at 50MHz	Insertion Loss at 100MHz	Insertion Loss at 150MHz	Insertion Loss at 200MHz	Insertion Loss at 300MHz	Insertion Loss at 400MHz	Insertion Loss at 500MHz	Insertion Loss at 1000MHz
NFW31SP106X1E4□	10MHz	6dB max.	5dB min.	25dB min.	25dB min.	-	25dB min.	-	-	30dB min.	30dB min.
NFW31SP206X1E4□	20MHz	-	6dB max.	5dB min.	25dB min.	-	25dB min.	-	-	30dB min.	30dB min.
NFW31SP506X1E4□	50MHz	-	-	6dB max.	10dB min.	-	30dB min.	-	-	30dB min.	30dB min.
NFW31SP107X1E4□	100MHz	-	-	-	6dB max.	-	5dB min.	-	-	20dB min.	30dB min.
NFW31SP157X1E4□	150MHz	-	-	-	-	6dB max.	-	10dB min.	20dB min.	30dB min.	30dB min.
NFW31SP207X1E4□	200MHz	-	-	-	-	-	6dB max.	-	-	10dB min.	30dB min.
NFW31SP307X1E4□	300MHz	-	-	-	-	-	-	6dB max.	-	5dB min.	15dB min.
NFW31SP407X1E4□	400MHz	-	-	-	-	-	-	-	6dB max.	-	10dB min.
NFW31SP507X1E4□	500MHz	-	-	-	-	-	-	-	-	6dB max.	10dB min.

Rated Current: 200mA Rated Voltage: 25Vdc Operating Temperature Range: -40°C to 85°C Number of Circuit: 1

Insertion Loss Characteristics

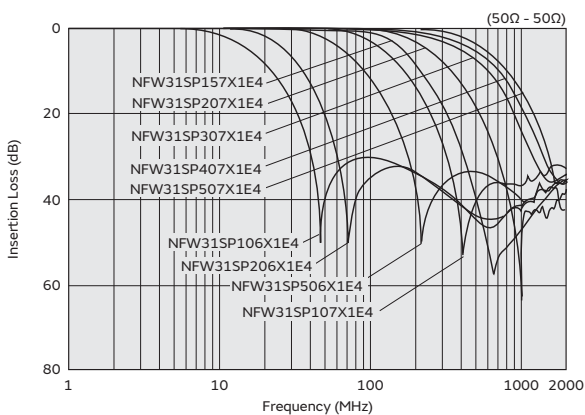

Chip EMIFIL® (NFL/NFA/NFW/NFE) ⚠Caution/Notice

⚠Caution

Rating

Do not use products beyond the rated current and rated voltage as this may create excessive heat and deteriorate the insulation resistance.

Notice

Storage and Operating Conditions

<Operating Environment>

Do not use products in a chemical atmosphere such as chlorine gas, acid or sulfide gas.

Do not use products in an environment close to an organic solvent.

<Storage and Handling Requirements>

1. Storage Period

Should be used within 12 months. Solderability should be

checked if this period is exceeded.

2. Storage Conditions

(1) Storage temperature: -10 to +40°C

Relative humidity: 15 to 85%

Avoid sudden changes in temperature and humidity.

(2) Do not store products in a chemical atmosphere such as chlorine gas, acid or sulfide gas.

Notice (Soldering and Mounting)

1. Cleaning

Failure and degradation of a product can be caused by the cleaning method. When you clean in conditions that are not in the mounting information, please contact Murata engineering.

2. Soldering

Reliability decreases with improper soldering methods. Please solder by the standard soldering conditions shown in the mounting information.

3. Other

Noise suppression levels resulting from Murata's EMI suppression filters EMIFIL® may vary, depending on the circuits and ICs used, type of noise, mounting pattern, mounting location, and other operating conditions. Be sure to check and confirm in advance the noise suppression effect of each filter, in actual circuits, etc. before applying the filter in a commercial-purpose equipment design.

Handling

1. Resin Coating

Using resin for coating/molding products may affect the product's performance.

So please pay careful attention in selecting resin.

Prior to use, please make a reliability evaluation with the product mounted in your application set.

2. Caution for Use (NFW Series)

When you hold products with a tweezer, please hold by the sides. Sharp materials, such as a pair of tweezers or other material such as cleaning brush bristles, should not touch the winding portion of this product to prevent breaking the wire. To prevent breaking the core, mechanical shock should not be applied to the products mounted on the board.

3. Handling of Substrates

After mounting products on a substrate, do not apply any stress to the product by bending or twisting the substrate when cropping the substrate, inserting and removing a connector from the substrate or tightening a screw to the substrate.

Excessive mechanical stress may cause cracking in the product.

Bending

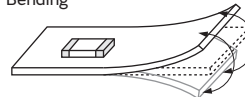

Twisting

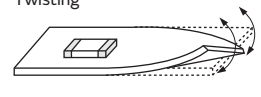

Chip EMIFIL® (NFL/NFA/NFW/NFE) Soldering and Mounting

1. Standard Land Pattern Dimensions

NF□ series suppresses noise by conducting the high-frequency noise element to ground. Therefore, to obtain maximum performance from these filters, the ground pattern should be made as large as possible during the PCB design stage. As shown below, one side of the PCB is used for chip mounting, and the other is used for grounding.

Small diameter feed-through holes are then used to connect the grounds on each side of the PCB. This reduces the high-frequency impedance of the grounding and maximizes the filter's performance.

Land Pattern + Solder Resist
 Land Pattern
 Solder Resist (in mm)

Series	Standard Land Dimensions	
NFL18SP NFL18ST NFL21SP	<p>● Reflow Soldering</p> <div style="display: flex; justify-content: space-around;"> <div data-bbox="336 629 624 920"> <p>NFL18SP Small diameter thru hole $\phi 0.2-\phi 0.3$</p> </div> <div data-bbox="759 629 1046 920"> <p>NFL18ST Small diameter thru hole $\phi 0.2-\phi 0.3$</p> </div> <div data-bbox="1198 629 1461 920"> <p>NFL21SP Small diameter thru hole $\phi 0.4$</p> </div> </div>	
NFA18SL NFA18SD NFA21SL	<p>● Reflow Soldering</p> <div style="display: flex; justify-content: space-around;"> <div data-bbox="488 999 783 1290"> <p>NFA18SL/NFA18SD</p> </div> <div data-bbox="855 999 1350 1290"> <p>NFA21SL Small diameter thru hole $\phi 0.2$</p> </div> </div>	
NFW31SP NFE31PT	<p>● Reflow and Flow NFW31SP ● Reflow Soldering NFE31PT</p> <div style="display: flex; justify-content: center;"> <div data-bbox="360 1402 703 1671"> <p>Small diameter thru hole $\phi 0.4$</p> </div> </div>	
NFE61PT	<p>● Reflow Soldering</p> <div style="display: flex; justify-content: center;"> <div data-bbox="512 1771 767 1995"> <p>Small diameter thru hole $\phi 0.4$</p> </div> </div>	<p>● Flow Soldering</p> <div style="display: flex; justify-content: center;"> <div data-bbox="1094 1771 1366 2018"> <p>Small diameter thru hole $\phi 0.4$</p> </div> </div>

Continued on the following page. ↗

Chip EMIFIL® (NFL/NFA/NFW/NFE) Soldering and Mounting

Continued from the preceding page. ↘

● PCB Warping

PCB should be designed so that products are not subjected to mechanical stress caused by warping the board.

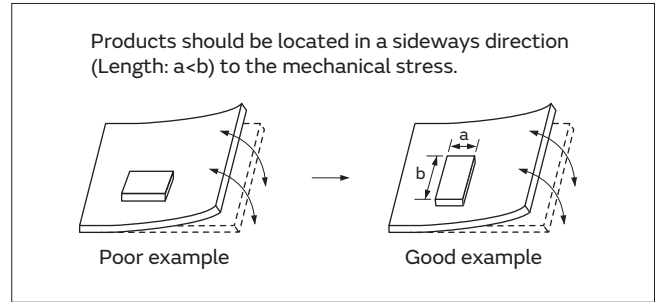

2. Solder Paste Printing and Adhesive Application

When reflow soldering the chip EMI suppression filter, the printing must be conducted in accordance with the following cream solder printing conditions.

If too much solder is applied, the chip will be prone to damage by mechanical and thermal stress from the PCB and may crack.

Standard land dimensions should be used for resist and copper foil patterns.

When flow soldering the EMI suppression filter, apply the adhesive in accordance with the following conditions. If too much adhesive is applied, it may overflow into the land or termination areas and yield poor solderability. In contrast, if insufficient adhesive is applied, or if the adhesive is not sufficiently hardened, then the chip may become detached during the flow soldering process.

Series	Solder Paste Printing	Adhesive Application
NFL18SP NFL18ST NFL21SP NFA18SL NFA18SD NFA21SL	<p>●Guideline of solder paste thickness: 100-150µm: NFL, NFA18SL/18SD/21SL</p> <div style="display: flex; justify-content: space-around;"> <div style="text-align: center;"> <p>NFL18SP</p> </div> <div style="text-align: center;"> <p>NFL18ST</p> </div> </div> <div style="display: flex; justify-content: space-around; margin-top: 10px;"> <div style="text-align: center;"> <p>NFL21SP</p> </div> <div style="text-align: center;"> <p>NFA18SL/18SD</p> </div> </div> <div style="text-align: center; margin-top: 10px;"> <p>NFA21SL</p> </div>	<p style="text-align: right;">(in mm)</p>

Continued on the following page. ↗

Chip EMIFIL® (NFL/NFA/NFW/NFE) Soldering and Mounting

Continued from the preceding page. ↘

(in mm)

Series	Solder Paste Printing	Adhesive Application
NFW31SP NFE31PT	<p>●Guideline of solder paste thickness: 150-200μm</p>	<p>NFW31SP Series Apply 0.2mg of bonding agent at each chip.</p>
NFE61PT	<p>●Guideline of solder paste thickness: 150-200μm</p>	<p>Apply 1.0mg of bonding agent at each chip.</p>

3. Standard Soldering Conditions

(1) Soldering Methods

Use flow and reflow soldering methods only.
 Use standard soldering conditions when soldering chip EMI suppression filters.
 In cases where several different parts are soldered, each having different soldering conditions, use those conditions requiring the least heat and minimum time.

Solder: Use Sn-3.0Ag-0.5Cu solder. Use of Sn-Zn based solder will deteriorate performance of products.

Flux:

- Use rosin-based flux.
 In case of using RA type solder, products should be cleaned completely with no residual flux.
- Do not use strong acidic flux (with chlorine content exceeding 0.20wt%)
- Do not use water-soluble flux.

For additional mounting methods, please contact Murata.

(2) Soldering Profile

- Flow Soldering Profile (Sn-3.0Ag-0.5Cu Solder)

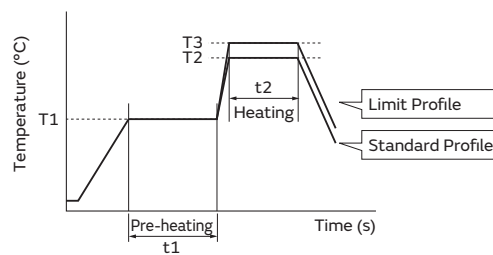

Series	Pre-heating		Standard Profile			Limit Profile		
	Temp. (T1)	Time (t1)	Heating		Cycle of Flow	Heating		Cycle of Flow
			Temp. (T2)	Time (t2)		Temp. (T3)	Time (t2)	
NFE61PT	150°C	60s min.	250°C	4 to 6s	2 times max.	265±3°C	5s max.	2 times max.
NFW31SP	150°C	60s min.	250°C	4 to 6s	2 times max.	265±3°C	5s max.	1 times max.

Continued on the following page. ↗

Chip Ferrite Bead

Application Specified Noise Filter

Chip EMIFIL®

Common Mode Choke Coil
 Common Mode Noise Filter

Block Type EMIFIL®

EMC Absorber

Chip EMIFIL® (NFL/NFA/NFW/NFE) Soldering and Mounting

Continued from the preceding page. ↘

●Reflow Soldering Profile (Sn-3.0Ag-0.5Cu Solder)

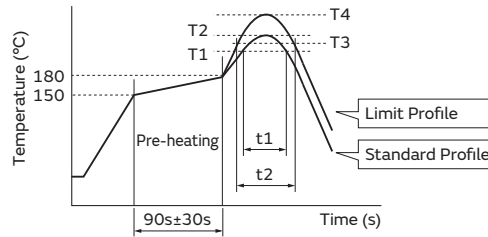

Series	Standard Profile				Limit Profile			
	Heating		Peak Temperature (T2)	Cycle of Reflow	Heating		Peak Temperature (T4)	Cycle of Reflow
	Temp. (T1)	Time (t1)			Temp. (T3)	Time (t2)		
NFA18S/21S NFE, NFL	220°C min.	30 to 60s	245±3°C	2 times max.	230°C min.	60s max.	260°C/10s	2 times max.
NFW31SP	220°C min.	30 to 60s	245±3°C	2 times max.	230°C min.	60s max.	260°C/10s	1 times max.

(3) Reworking with a soldering Iron

The following conditions must be strictly followed when using a soldering iron.

Pre-heating: 150°C 60s min.

Soldering iron power output / Tip diameter:
 30W max. / ø3mm max.

Temperature of soldering iron tip / Soldering time / Times:
 350°C max. / 3-4s / 2 times*1

*1 NFE31PT152Z1E9: 280°C max. / 10s max. / 2 times

Do not allow the tip of the soldering iron to directly contact the chip.

For additional methods of reworking with a soldering iron, please contact Murata engineering.

4. Cleaning

The following conditions should be observed when cleaning chip EMI filters.

(1) Cleaning temperature: 60°C max. (40°C max. for alcohol type cleaner)

(2) Ultrasonic

Output: 20W/liter max.

Duration: 5 minutes max.

Frequency: 28 to 40kHz

(3) Cleaning Agent

The following cleaning agents have been tested on the individual components. Evaluation of final assembly should be completed prior to production.

(a) Alcohol cleaning agent

Isopropyl alcohol (IPA)

(b) Aqueous cleaning agent

Pine Alpha ST-100S

(4) Ensure that flux residue is completely removed.

The component should be thoroughly dried after the aqueous agent has been removed with deionized water.

Chip EMIFIL® (NFL/NFA/NFW/NFE) Packaging

Minimum Quantity and Dimensions of 8mm Width Paper / Embossed Tape

(Common to Paper Tape / Embossed Tape)

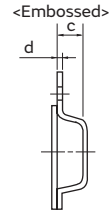
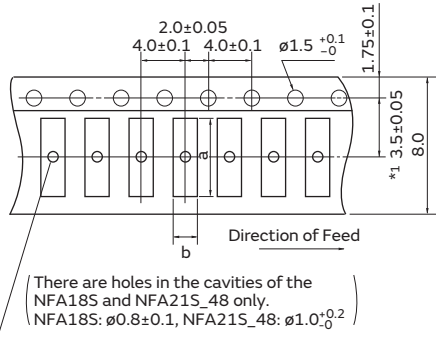

c: Depth of Cavity (Embossed Tape)

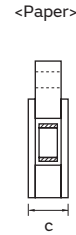

c: Total Thickness of Tape (Paper Tape)

Dimension of the cavity of embossed tape is measured at the bottom side.

Part Number	Dimensions				Minimum Qty. (pcs.)				Bulk
					ø180mm Reel		ø330mm Reel		
	a	b	c	d	Paper Tape	Embossed Tape	Paper Tape	Embossed Tape	
NFL18SP/NFL18ST_H	1.85	1.05	0.9 max.	-	4000	-	-	-	1000
NFL18ST_X			1.1 max.						
NFL21SP	2.3	1.55	1.1 max.	-	-	-	-	-	-
NFA18SL/18SD	1.8	1.0	0.7	0.25	-	4000	-	-	1000
NFA21SL_45	2.30	1.55	0.7	0.25	-	4000	-	-	1000
NFA21SL_48	2.25	1.45	1.05	0.25	-	4000	-	-	1000
NFE31PT	3.6	1.8	1.85	0.2	-	2000	-	8000	500
NFW31SP	3.6	1.9	2.0	0.2	-	2000	-	7500	-

(in mm)

Minimum Quantity and Dimensions of 12mm Width Embossed Tape

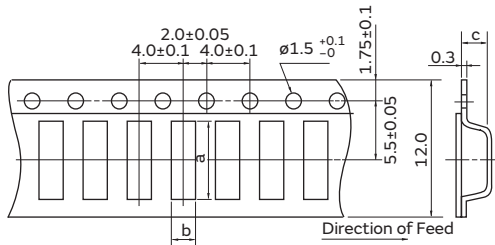

c: Depth of Cavity

Dimension of the cavity is measured at the bottom side.

Part Number	Dimensions			Minimum Qty. (pcs.)		
	a	b	c	ø180mm Reel	ø330mm Reel	Bulk
NFE61PT	7.2	1.9	1.75	2500	8000	500

(in mm)

"Minimum Quantity" means the number of units of each delivery or order. The quantity should be an integral multiple of the "Minimum Quantity."

Common Mode Choke Coil
· Common Mode Noise Filter
DLM/DLP/DLW/NFP/PLT Series

Series Introduction	p192
Part Numbering	p194
Series Lineup	p198
Product Detail	p202
⚠Caution/Notice	p240
Soldering and Mounting	p243
Packaging	p250

Common Mode Choke Coil/Common Mode Noise Filter (DL□/ NFP/PLT) Series Introduction

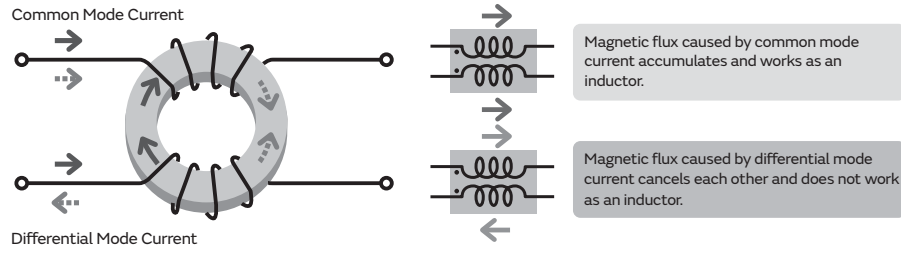

Category	Features, Classification	Structure	Part Number	Comments	
For signal lines	Ultra-high cut-off frequency for high-speed differential signal lines	Multilayer type	<ul style="list-style-type: none"> DLMOQSB_HY2 DLMONSB_HY2 	<ul style="list-style-type: none"> High common impedance for outstanding noise control effectiveness. 	
		Film type	<ul style="list-style-type: none"> NFP0QHB_HS2 NFP0QSB_HL2 DLPOQSA DLP0NSA DLP11SA DLP11RB DLP11TB DLP2ADA 	<ul style="list-style-type: none"> Low profile, small size, suitable for mobile equipment. Tight terminal pitch enables high-density layout. Very high cut-off frequency and its matching to characteristic impedance enable good transmission of high-speed signals. DLP2ADA is an array-type product incorporating two circuits. 	
		Winding type	<ul style="list-style-type: none"> DLW21SN_HQ2 DLW21HN_HQ2 DLW21SN_XK2 DLW21SN_XQ2 	<ul style="list-style-type: none"> Very high self-resonance frequency enables high cut-off frequency. Its matching to characteristic impedance enables good transmission of high-speed signals. DLW21HN_HQ2 is designed to be low profile. 	
	High cut-off frequency for high-speed differential signal lines	Multilayer type	Multilayer type	<ul style="list-style-type: none"> DLM11SN_HY2 DLMOQSN DLMONSN 	<ul style="list-style-type: none"> Enables noise suppression for differential signal lines without distortion in high-speed signal transmission. High cut-off frequency and its matching to characteristic impedance enable good transmission of high-speed signals.
			Film type	<ul style="list-style-type: none"> DLP0NSC DLP0NSN 	<ul style="list-style-type: none"> Low profile, small size, suitable for mobile equipment. Tight terminal pitch enables high-density layout. High cut-off frequency and its matching to characteristic impedance enable good transmission of high-speed signals.
				<ul style="list-style-type: none"> DLP11SN DLP11RN 	<ul style="list-style-type: none"> Low profile, small size, suitable for mobile equipment. High cut-off frequency enables good transmission of high-speed signals. DLP11RN has low DC resistance to reduce attenuation of the signal.
		Winding type	<ul style="list-style-type: none"> DLP1NDN DLP2ADN 	<ul style="list-style-type: none"> Array-type product incorporating two circuits. Very high cut-off frequency and its matching to characteristic impedance enable good transmission of high-speed signals. 	
			<ul style="list-style-type: none"> DLW21SN_SQ2 DLW21HN_SQ2 DLW21SN_SK2 DLW31SN 	<ul style="list-style-type: none"> High impedance in the high frequency band for more effective noise suppression. High self-resonance frequency enables high cut-off frequency. DLW21HN_SQ2 is designed to be low profile. 	
		<ul style="list-style-type: none"> DLW21SR 	<ul style="list-style-type: none"> Matches the characteristic impedance to enable good transmission of high-speed signals. Particularly suitable for the receiving side of the HDMI interface. 		
	For general differential signal lines	Film type	<ul style="list-style-type: none"> DLP31SN DLP31DN 	<ul style="list-style-type: none"> High common impedance for outstanding noise control effectiveness. DLP31D is an array-type product incorporating two circuits. 	
	For power lines		Winding type	<ul style="list-style-type: none"> DLW44SM 	<ul style="list-style-type: none"> Supports large currents (3.1 A max.) and is designed to be low profile.
				<ul style="list-style-type: none"> DLW5AHN DLW5BSM DLW5ATN DLW5BTM 	<ul style="list-style-type: none"> Supports large currents (6 A max.), suitable for input connector from an AC adaptor. DLW5AT/DLW5BT is designed to be low profile.
For audio lines		Multilayer type	<ul style="list-style-type: none"> DLM11GN 	<ul style="list-style-type: none"> Modified differential mode impedance is higher than other common mode choke coils; this feature makes it possible to suppress both common mode and differential mode noise. Ideal to maintain low distortion audio signals. 	
For power lines	Large current automotive available	Winding type	<ul style="list-style-type: none"> PLT5BPH 	<ul style="list-style-type: none"> Highly reliable and supports large currents (up to 5.6 A). Suitable for power lines for ADAS, IVI, and similar systems. 	
		Winding type cased structure	<ul style="list-style-type: none"> PLT10HH 	<ul style="list-style-type: none"> Highly reliable and supports large currents (up to 18 A). Suitable for power lines for DC-DC converters and other electrical components in motors, HEVs, and Evs. 	

Common Mode Choke Coil/Common Mode Noise Filter (DLP/DLW Series) Noise Suppression Example

Skew Improvement Effect of Common Mode Choke Coil

Example of Skew Improvement by Common Mode Choke Coil
 (Tested using pulse generator waveform)

Waveform is equivalent to 1000Mbps signal

Waveform with intentionally made skew (skew: 100ps)

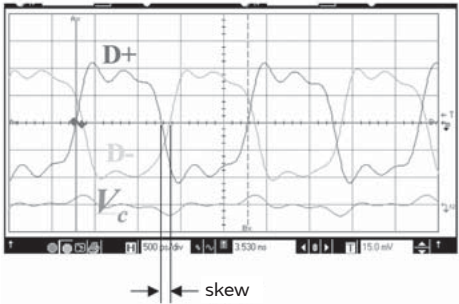

Skew is improved by common mode choke coil

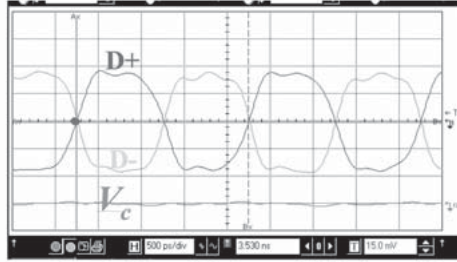

Mechanism of Skew Improvement

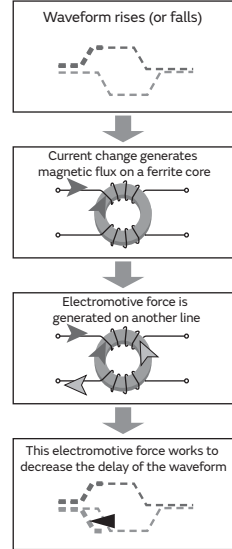

Noise Suppression of Common Mode Choke Coil in HDMI Line

Device under test / Transmitter: game machine

/ Receiver: projector

/ Cable: HDMI category 2 3m cable

Test resolution / 1080p Deep color 12bit (Data 1.11GHz) DVD play mode

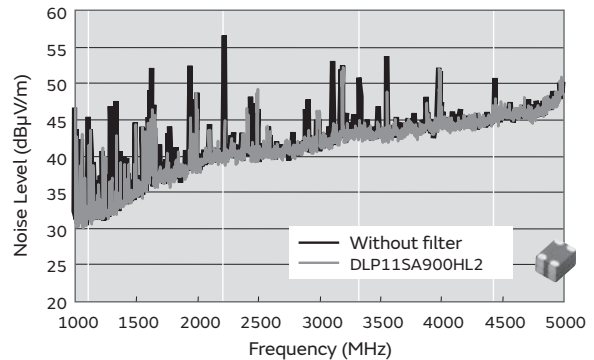
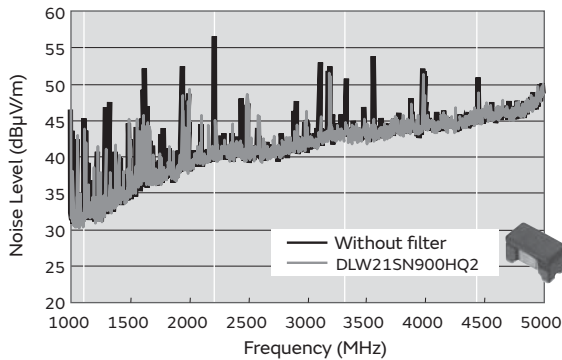

Test Example of HDMI 1.3 Waveform Transmission

~Using ESD protection device
 LXES15AAA1-100 (0.05pF)~

Signal frequency: 1.11GHz (Deep color 12bit)

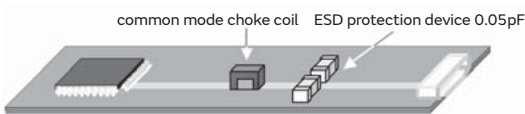
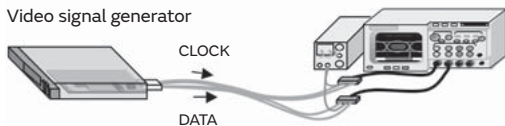

ESD protection device only

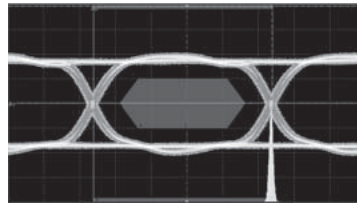

Film Type DLP11SN900HL2
 (Cut-off frequency is lowest in the table below)

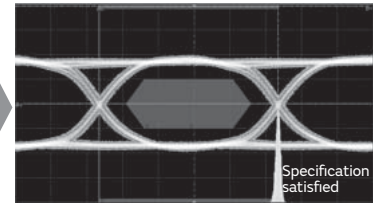

	Wound Type DLW21SN900HQ2	Film Type DLP11SA900HL2	Film Type Array DLP2ADN900HL4
Cut-off Frequency	Over 10GHz	Around 6GHz	Around 4GHz
Judgment	Specification satisfied	Specification satisfied	Specification satisfied
Transition Time	Rise time: 83.4ps Fall time: 77.4ps	Rise time: 90.4ps Fall time: 85.5ps	Rise time: 100ps Fall time: 97.4ps

Each common mode choke coil can keep the waveform and satisfy the specification.

● Part Numbering

Chip Common Mode Choke Coil

(Part Number)

DL	P	ON	S	N	900	H	L	2	L
①	②	③	④	⑤	⑥	⑦	⑧	⑨	⑩

① Product ID

Product ID	
DL	Chip Common Mode Choke Coils

② Structure

Code	Structure
M	Multilayer Type
P	Film Type

③ Dimensions (LxW)

Code	Dimensions (LxW)	Size Code (inch)
OQ	0.65x0.5mm	025020
ON	0.85x0.65mm	03025
11	1.25x1.0mm	0504
1N	1.5x0.65mm	05025
2A	2.0x1.0mm	0804
31	3.2x1.6mm	1206

④ Features (1)

Code	Type
S	Magnetically Shielded One Circuit Type
D	Magnetically Shielded Two Circuit Type
G	Magnetically Shielded Audio Type
R/T	One Circuit Low Profile Type

⑤ Category

Code	Category
A	For General
B	
C	
N	

⑥ Impedance

Typical impedance at 100MHz is expressed by three figures. The unit is in ohm (Ω). The first and second figures are significant digits, and the third figure expresses the number of zeros that follow the two figures.

⑦ Circuit

Code	Circuit
S	Expressed by a letter.
M	
H	
U	

⑧ Features (2)

Code	Features
D	Expressed by a letter.
L	
Y	

⑨ Number of Signal Lines

Code	Number of Signal Lines
2	Two Lines
4	Four Lines

⑩ Packaging

Code	Packaging
L	Embossed Taping (ϕ 180mm Reel)
D	Paper Taping (ϕ 180mm Reel)
B	Bulk

Chip Common Mode Choke Coil

(Part Number)

DL	W	21	S	N	371	S	Q	2	L
①	②	③	④	⑤	⑥	⑦	⑧	⑨	⑩

① Product ID

Product ID	
DL	Chip Common Mode Choke Coils

② Structure

Code	Structure
W	Wire Wound Type

③ Dimensions (LxW)

Code	Dimensions (LxW)	Size Code (inch)
21	2.0x1.2mm	0805
31	3.2x1.6mm	1206
44	4.0x4.0mm	1515
5A	5.0x3.6mm	2014
5B	5.0x5.0mm	2020

④ Features (1)

Code	Type
S	Magnetically Shielded One Circuit Type
H	Open Magnetic One Circuit Type
T	One Circuit Low Profile Type

⑤ Category

Code	Category
M	For General-Purpose
N	
R	

⑥ Impedance

Typical impedance at 100MHz is expressed by three figures. The unit is in ohm (Ω). The first and second figures are significant digits, and the third figure expresses the number of zeros that follow the two figures.

Typical impedance at peak frequency should be applied for the product whose impedance peak frequency is less than 100MHz. (DLW44SM)

⑥ Inductance (DLW43SH)

Expressed by three figures. The unit is micro-henry (μH). The first and second figures are significant digits, and the third figure expresses the number of zeros which follow the two figures.

⑦ Circuit

Code	Circuit
S	Expressed by a letter.
M	
H	
T	
X	

⑧ Features (2)

Code	Features
K	Expressed by a letter.
Q	

⑨ Number of Signal Lines

Code	Number of Signal Lines
2	Two Lines

⑩ Packaging

Code	Packaging
K	Embossed Taping (\varnothing 330mm Reel)
L	Embossed Taping (\varnothing 180mm Reel)
B	Bulk

Common Mode Noise Filter

(Part Number)

NF	P	OR	S	N	112	H	L	2	D
1	2	3	4	5	6	7	8	9	10

① Product ID

Product ID	
NF	Chip EMIFIL®

② Structure

Code	Structure
P	Film Type Common Mode Noise Filter

③ Dimensions (LxW)

Code	Dimensions (LxW)	Size Code (inch)
OQ	0.65x0.5mm	025020

④ Features (1)

Code	Type
S	Standard 1 Circuit
H	High Insertion Loss 1 Circuit

⑤ Category

Code	Category
B	High Cut-Off Frequency

⑥ SRF

Typical SRF of common mode noise suppression effect is expressed by three figures. The unit is in MHz. The first and second figures are significant digits, and the third figure expresses the number of zeros that follow the two figures.

⑦ Circuit

Code	Circuit
H	Expressed by a letter

⑧ Features (2)

Code	Features
L	Expressed by a letter
S	

⑨ Number of Signal Lines

Code	Number of Signal Lines
2	Two Lines

⑩ Packaging

Code	Packaging
D	Paper Taping (ø180mm Reel)
B	Bulk

Common Mode Choke Coil

(Part Number)

PL	T	10H	H	102	6R0	P	N	B
①	②	③	④	⑤	⑥	⑦	⑧	⑨

① Product ID

Product ID	
PL	Common Mode Choke Coils

② Type

Code	Type
T	DC Type

③ Applications

Code	Applications
10H	For DC Line High-frequency Type
5BP	5.0x5.0mm Size, for DC Lines

④ Features (1)

Code	Features	
H	For Automotive	Powertrain, Safety

⑤ Impedance

Expressed by three figures. The unit is ohm (Ω). The first and second figures are significant digits, and the third figure expresses the number of zeros that follow the two figures.

⑥ Rated Current

Expressed by three figures. The unit is ampere (A). The first and second figures are significant digits, and the third figure expresses the number of zeros that follow the two figures. A decimal point is expressed by the capital letter "R." In this case, all figures are significant digits.

⑦ Features (2)

Code	Features
P	Expressed by a letter.
S	

⑧ Lead Dimensions

Code	Lead Dimensions
N	No Lead Terminal (SMD)

⑨ Packaging

Code	Packaging
B	Bulk
L	Embossed Taping (ϕ 178mm/ ϕ 180mm Reel)
K	Embossed Taping (ϕ 330mm Reel)

Series Lineup

DLM/DLP/DLW/NFP

Common Mode Choke Coil/Common Mode Noise Filter

Type	Size Code in inches (mm)	Thickness (mm)	Part Number	Common Mode Impedance (at 100MHz)	Rated Current	
Multilayer Type Limited for differential signal interface line	025020 (0605)	0.3	DLM0QSB120HY2 <small>p202</small>	12Ω±5Ω	150mA	
		0.3	DLM0QSB350HY2 <small>p202</small>	35Ω±30%	120mA	
		0.3	DLM0QSN500HY2 <small>p202</small>	50Ω±35%	100mA	
		0.3	DLM0QSN650HY2 <small>p202</small>	65Ω±35%	100mA	
		0.3	DLM0QSN900HY2 <small>p202</small>	90Ω±25%	50mA	
	03025 (0806)	0.45	DLM0NSB120HY2 <small>p203</small>	12Ω±5Ω	160mA	
		0.45	DLM0NSB280HY2 <small>p203</small>	28Ω±30%	130mA	
		0.45	DLM0NSN500HY2 <small>p203</small>	50Ω±25%	100mA	
		0.45	DLM0NSN900HY2 <small>p203</small>	90Ω±25%	100mA	
	Multilayer Type for Audio Lines	0504 (1210)	0.5	DLM11GN601SD2 <small>p205</small>	600Ω±25%	100mA
Multilayer Type for Differential Signal Lines	0.5		DLM11SN450HY2 <small>p206</small>	45Ω±25%	100mA	
	0.5		DLM11SN900HY2 <small>p206</small>	90Ω±25%	100mA	
Film Type for Differential Signal Lines	025020 (0605)	0.3	DLP0QSA070HL2 <small>p207</small>	7Ω±2Ω	100mA	
		0.3	DLP0QSA150HL2 <small>p207</small>	15Ω±5Ω	100mA	
		0.3	DLP0QSA350HL2 <small>p207</small>	35Ω±10Ω	100mA	
	03025 (0806)	0.45	DLP0NSN350HL2 <small>p208</small>	35Ω±10Ω	100mA	
		0.45	DLP0NSN670HL2 <small>p208</small>	67Ω±20%	110mA	
		0.45	DLP0NSN900HL2 <small>p208</small>	90Ω±20%	100mA	
		0.45	DLP0NSN121HL2 <small>p208</small>	120Ω±20%	90mA	
		0.45	DLP0NSA070HL2 <small>p208</small>	7Ω±2Ω	100mA	
		0.45	DLP0NSA150HL2 <small>p208</small>	15Ω±5Ω	100mA	
		0.45	DLP0NSC280HL2 <small>p208</small>	28Ω±20%	100mA	
		0.45	DLP0NSC900HL2 <small>p208</small>	90Ω±35%	75mA	
	0504 (1210)	0.5	DLP11RB150UL2 <small>p210</small>	15Ω±5Ω	100mA	
		0.5	DLP11RB400UL2 <small>p210</small>	40Ω±10Ω	100mA	
		0.5	DLP11RN450UL2 <small>p210</small>	45Ω±25%	100mA	
		0.82	DLP11SN900HL2 <small>p212</small>	90Ω±20%	150mA	
		0.82	DLP11SN201HL2 <small>p212</small>	200Ω±20%	110mA	
		0.82	DLP11SN241HL2 <small>p212</small>	240Ω±20%	100mA	
		0.82	DLP11SN281HL2 <small>p212</small>	280Ω±20%	90mA	
		0.82	DLP11SN331HL2 <small>p212</small>	330Ω±20%	80mA	
		0.82	DLP11SN670SL2 <small>p212</small>	67Ω±20%	180mA	
		0.82	DLP11SN121SL2 <small>p212</small>	120Ω±20%	140mA	
		0.82	DLP11SN161SL2 <small>p212</small>	160Ω±20%	120mA	
		0.82	DLP11SA350HL2 <small>p212</small>	35Ω±20%	170mA	
		0.82	DLP11SA670HL2 <small>p212</small>	67Ω±20%	150mA	
		0.82	DLP11SA900HL2 <small>p212</small>	90Ω±20%	150mA	
	1206 (3216)	0.3	DLP11TB800UL2 <small>p214</small>	80Ω±25%	100mA	
		1.15	DLP31SN121ML2 <small>p215</small>	120Ω±20%	100mA	
		1.15	DLP31SN221ML2 <small>p215</small>	220Ω±20%	100mA	
	Film Array Type for Differential Signal Lines	05025 (1506)	1.15	DLP31SN551ML2 <small>p215</small>	550Ω±20%	100mA
			0.45	DLP1NDN350HL4 <small>p216</small>	35Ω±20%	100mA
0.45			DLP1NDN670HL4 <small>p216</small>	67Ω±20%	80mA	
0804 (2010)		0.45	DLP1NDN900HL4 <small>p216</small>	90Ω±20%	60mA	
		0.82	DLP2ADN670HL4 <small>p217</small>	67Ω±20%	140mA	
		0.82	DLP2ADN900HL4 <small>p217</small>	90Ω±20%	130mA	
		0.82	DLP2ADN121HL4 <small>p217</small>	120Ω±20%	120mA	
		0.82	DLP2ADN161HL4 <small>p217</small>	160Ω±20%	100mA	
		0.82	DLP2ADN201HL4 <small>p217</small>	200Ω±20%	90mA	
0.82	DLP2ADN241HL4 <small>p217</small>	240Ω±20%	80mA			
0.82	DLP2ADN281HL4 <small>p217</small>	280Ω±20%	80mA			

Continued on the following page. ↗

Type	Size Code in inches (mm)	Thickness (mm)	Part Number	Common Mode Impedance (at 100MHz)	Rated Current
Film Array Type for Differential Signal Lines	0804 (2010)	0.82	DLP2ADA350HL4 p217	35Ω±20%	150mA
		0.82	DLP2ADA670HL4 p217	67Ω±20%	130mA
		0.82	DLP2ADA900HL4 p217	90Ω±20%	120mA
	1206 (3216)	1.15	DLP31DN900ML4 p219	90Ω±20%	160mA
		1.15	DLP31DN131ML4 p219	130Ω±20%	120mA
		1.15	DLP31DN201ML4 p219	200Ω±20%	100mA
		1.15	DLP31DN321ML4 p219	320Ω±20%	80mA
Wire Wound Type for Differential Signal Lines	0805 (2012)	0.9	DLW21HN670SQ2 p220	67Ω±25%	330mA
		0.9	DLW21HN900SQ2 p220	90Ω±25%	330mA
		0.9	DLW21HN121SQ2 p220	120Ω±25%	280mA
		0.9	DLW21HN181SQ2 p220	180Ω±25%	250mA
		0.9	DLW21HN670HQ2 p220	67Ω±25%	240mA
		0.9	DLW21HN900HQ2 p220	90Ω±25%	220mA
		0.9	DLW21HN121HQ2 p220	120Ω±25%	200mA
		1.2	DLW21SN670SQ2 p222	67Ω±25%	400mA
		1.2	DLW21SN900SQ2 p222	90Ω±25%	330mA
		1.2	DLW21SN121SQ2 p222	120Ω±25%	370mA
		1.2	DLW21SN181SQ2 p222	180Ω±25%	330mA
		1.2	DLW21SN261SQ2 p222	260Ω±25%	300mA
		1.2	DLW21SN371SQ2 p222	370Ω±25%	280mA
		1.2	DLW21SN501SK2 p222	500Ω±25%	250mA
	1.2	DLW21SN921SK2 p222	920Ω±25%	160mA	
	1.2	DLW21SN670HQ2 p222	67Ω±25%	320mA	
	1.2	DLW21SN900HQ2 p222	90Ω±25%	280mA	
	1.2	DLW21SN121HQ2 p222	120Ω±25%	280mA	
	1.2	DLW21SN211XK2 p222	210Ω±25%	360mA	
	1.2	DLW21SN181XQ2 p222	180Ω±25%	240mA	
	1.2	DLW21SN261XQ2 p222	260Ω±25%	220mA	
	1.2	DLW21SN491XQ2 p222	490Ω±25%	190mA	
	1.2	DLW21SR670HQ2 p222	67Ω±25%	400mA	
	1206 (3216)	1.9	DLW31SN900SQ2 p225	90Ω±25%	370mA
		1.9	DLW31SN161SQ2 p225	160Ω±25%	340mA
		1.9	DLW31SN261SQ2 p225	260Ω±25%	310mA
		1.9	DLW31SN601SQ2 p225	600Ω±25%	260mA
1.9		DLW31SN102SQ2 p225	1000Ω±25%	230mA	
1.9		DLW31SN222SQ2 p225	2200Ω±25%	200mA	
Film Type for Differential Signal Lines	025020 (0605)	0.3	NFP0QHB242HS2 p226	-	100mA
		0.3	NFP0QHB372HS2 p226	-	100mA
		0.3	NFP0QHB542HS2 p226	-	100mA
		0.3	NFP0QSB132HL2 p226	90Ω (Typ.)	100mA
Wire Wound Type for Power Lines	1515 (4040)	1.4	DLW44SM101SK2 p228	100Ω (Typ.)	3.1A
		1.4	DLW44SM251SK2 p228	250Ω (Typ.)	2.6A
		1.4	DLW44SM401SK2 p228	400Ω (Typ.)	2.1A
		1.4	DLW44SM851SK2 p228	850Ω (Typ.)	1.9A
		1.4	DLW44SM172SK2 p228	1700Ω (Typ.)	1.5A
		1.4	DLW44SM302SK2 p228	2200Ω (Typ.)	1.1A
		1.4	DLW44SM242SK2 p228	2400Ω (Typ.)	1.4A
Wire Wound Type for Power Lines and Signal Lines	2014 (5036)	4.3	DLW5AHN402SQ2 p229	4000Ω (Typ.)	200mA
	2020 (5050)	4.5	DLW5BSM191SQ2 p229	190Ω (Typ.)	5A
		4.5	DLW5BSM351SQ2 p229	350Ω (Typ.)	2A

Continued on the following page. ↗

Type	Size Code in inches (mm)	Thickness (mm)	Part Number	Common Mode Impedance (at 100MHz)	Rated Current
Wire Wound Type for Power Lines and Signal Lines	2020 (5050)	4.5	DLW5BSM102SQ2 <small>p229</small>	1000Ω (Typ.)	1.5A
		4.5	DLW5BSM152SQ2 <small>p229</small>	1500Ω (Typ.)	1A
		4.5	DLW5BSM302SQ2 <small>p229</small>	3000Ω (Typ.)	500mA
	2014 (5036)	2.2	DLW5ATN111SQ2 <small>p231</small>	110Ω (Typ.)	5A
		2.2	DLW5ATN401SQ2 <small>p231</small>	400Ω (Typ.)	2A
		2.2	DLW5ATN501SQ2 <small>p231</small>	500Ω (Typ.)	1.5A
		2.2	DLW5ATN851SQ2 <small>p231</small>	850Ω (Typ.)	1.5A
		2.2	DLW5ATN272SQ2 <small>p231</small>	2700Ω (Typ.)	1A
		2.2	DLW5ATN500MQ2 <small>p233</small>	50Ω (Typ.)	6A
		2.2	DLW5ATN151MQ2 <small>p233</small>	150Ω (Typ.)	5A
		2.2	DLW5ATN331MQ2 <small>p233</small>	330Ω (Typ.)	4A
		2.2	DLW5ATN501MQ2 <small>p233</small>	500Ω (Typ.)	2.5A
		2.2	DLW5ATN112MQ2 <small>p233</small>	1100Ω (Typ.)	2A
		2.2	DLW5ATN111TQ2 <small>p234</small>	110Ω (Typ.)	5A
		2.2	DLW5ATN231TQ2 <small>p234</small>	230Ω (Typ.)	4A
		2.2	DLW5ATN401TQ2 <small>p234</small>	400Ω (Typ.)	2.5A
		2.2	DLW5ATN501TQ2 <small>p234</small>	500Ω (Typ.)	2A
		2020 (5050)	4.5	DLW5BSM501TQ2 <small>p235</small>	500Ω (Typ.)
	4.5		DLW5BSM601TQ2 <small>p235</small>	600Ω (Typ.)	1.4A
	4.5		DLW5BSM801TQ2 <small>p235</small>	800Ω (Typ.)	2A
	2.35		DLW5BTM101SQ2 <small>p236</small>	100Ω (Typ.)	6A
	2.35		DLW5BTM251SQ2 <small>p236</small>	250Ω (Typ.)	5A
	2.35		DLW5BTM501SQ2 <small>p236</small>	500Ω (Typ.)	4A
	2.35		DLW5BTM102SQ2 <small>p236</small>	1000Ω (Typ.)	2A
	2.35		DLW5BTM142SQ2 <small>p236</small>	1400Ω (Typ.)	1.5A
	2.35		DLW5BTM101TQ2 <small>p237</small>	100Ω (Typ.)	6A
	2.35		DLW5BTM251TQ2 <small>p237</small>	250Ω (Typ.)	5A
	2.35		DLW5BTM501TQ2 <small>p237</small>	500Ω (Typ.)	4A
	2.35		DLW5BTM102TQ2 <small>p237</small>	1000Ω (Typ.)	2.5A
	2.35	DLW5BTM142TQ2 <small>p237</small>	1400Ω (Typ.)	2A	

Chip Ferrite Bead

Application Specified Noise Filter

Chip EMIFIL®

Common Mode Choke Coil
Common Mode Noise Filter

Block Type EMIFIL®

EMC Absorber

PLT

Large Current Common Mode Choke Coil for Automotive Available

Size Code in inches (mm)	Thickness (mm)	Part Number	Common Mode Impedance (at 10MHz)	Rated Current
2020 (5050)	5.0	PLT5BPH1015R6SN <small>p238</small>	100Ω (Typ.)	5.6A
	5.0	PLT5BPH2014R4SN <small>p238</small>	200Ω (Typ.)	4.4A
	5.0	PLT5BPH3013R7SN <small>p238</small>	300Ω (Typ.)	3.7A
	5.0	PLT5BPH5013R1SN <small>p238</small>	500Ω (Typ.)	3.1A
(12.9X6.6)	9.4	PLT10HH450180PN <small>p239</small>	45Ω (Typ.)	18A
	9.4	PLT10HH101150PN <small>p239</small>	100Ω (Typ.)	15A
	9.4	PLT10HH401100PN <small>p239</small>	400Ω (Typ.)	10A
	9.4	PLT10HH501100PN <small>p239</small>	500Ω (Typ.)	10A
	9.4	PLT10HH9016R0PN <small>p239</small>	900Ω (Typ.)	6A
	9.4	PLT10HH1026R0PN <small>p239</small>	1000Ω (Typ.)	6A

Chip Ferrite Bead

Application Specified Noise Filter

Chip EMIFIL®

Common Mode Choke Coil
 Common Mode Noise Filter

Block Type EMIFIL®

EMC Absorber

Common mode choke coil/Common mode noise filter

DLM0QS Series 025020/0605(inch/mm)

Use for differential signal interface line.

Appearance/Dimensions

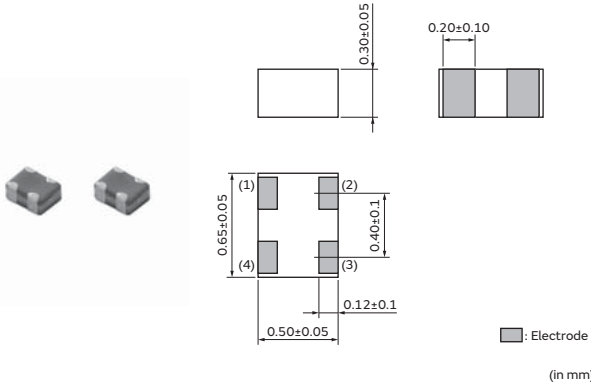

Packaging

Code	Packaging	Minimum Quantity
D	ø180mm Paper Tape	15000
B	Bulk(Bag)	500

Equivalent Circuit

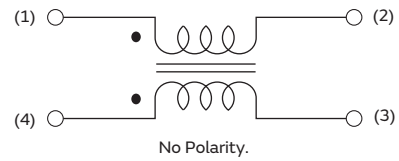

Rated Value (□: packaging code)

Part Number	Common Mode Impedance at 100MHz	Cutoff Frequency	Rated Current	Rated Voltage	Insulation Resistance (Min.)	Withstanding Voltage	DC Resistance
DLM0QSB120HY2□	12Ω±5%	8.0GHz (Typ.)	150mA	5Vdc	10MΩ	12.5Vdc	1.6Ω±25%
DLM0QSB350HY2□	35Ω±30%	8.0GHz (Typ.)	120mA	5Vdc	10MΩ	12.5Vdc	2.3Ω±25%
DLM0QSN500HY2□	50Ω±35%	4.0GHz (Typ.)	100mA	5Vdc	10MΩ	12.5Vdc	3.6Ω±25%
DLM0QSN650HY2□	65Ω±35%	4.0GHz (Typ.)	100mA	5Vdc	10MΩ	12.5Vdc	3.6Ω±25%
DLM0QSN900HY2□	90Ω±25%	2.0GHz (Typ.)	50mA	5Vdc	10MΩ	12.5Vdc	4.0Ω±25%

Operating Temp. Range: -40°C to 85°C

Z-f Characteristics: DLM0QS_HY2 Series

Differential mode transmission characteristics: DLM0QS_HY2series

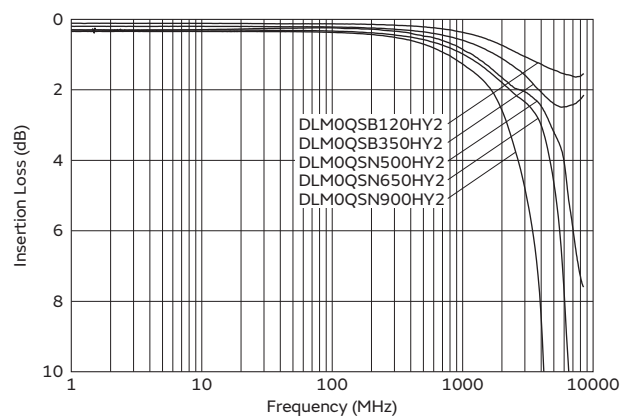
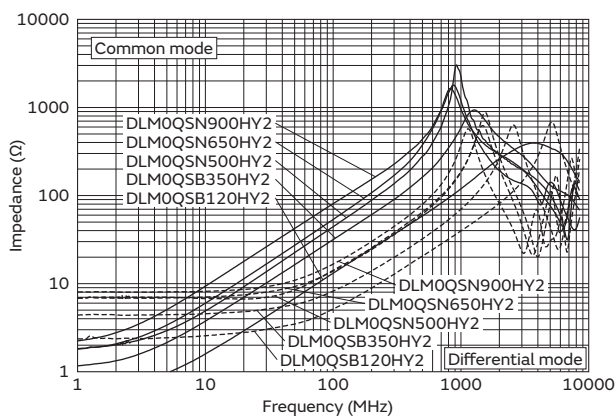

Common mode choke coil/Common mode noise filter

DLMONS Series 03025/0806(inch/mm)

Use for differential signal interface line.

Appearance/Dimensions

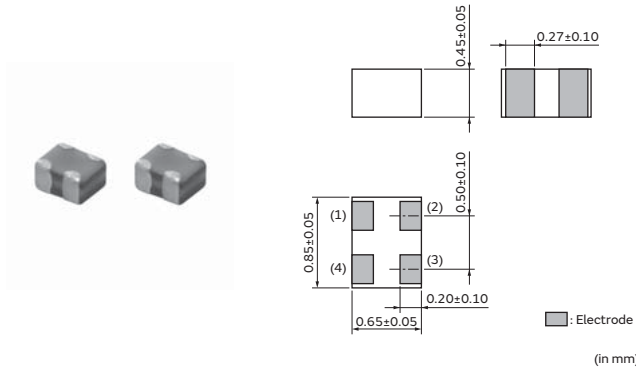

Packaging

Code	Packaging	Minimum Quantity
D	ø180mm Paper Tape	10000
B	Bulk(Bag)	500

Equivalent Circuit

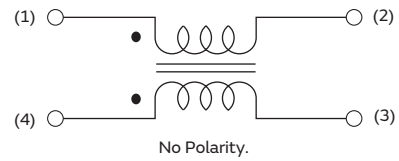

Rated Value (□: packaging code)

Part Number	Common Mode Impedance at 100MHz	Cutoff Frequency	Rated Current	Rated Voltage	Insulation Resistance (Min.)	Withstanding Voltage	DC Resistance
DLMONSB120HY2□	12Ω±5Ω	8.0GHz (Typ.)	160mA	5Vdc	10MΩ	12.5Vdc	1.2Ω±25%
DLMONSB280HY2□	28Ω±30%	8.0GHz (Typ.)	130mA	5Vdc	10MΩ	12.5Vdc	1.9Ω±25%
DLMONSN500HY2□	50Ω±25%	5.0GHz (Typ.)	100mA	5Vdc	10MΩ	12.5Vdc	2.7Ω±25%
DLMONSN900HY2□	90Ω±25%	2.0GHz (Typ.)	100mA	5Vdc	10MΩ	12.5Vdc	4.0Ω±25%

Operating Temp. Range: -40°C to 85°C

Z-f Characteristics: DLMONSB_HY2 Series

Differential mode transmission characteristics: DLMONSB_HY2series

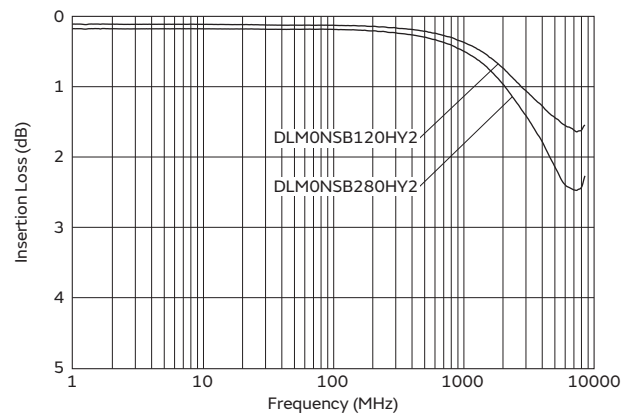
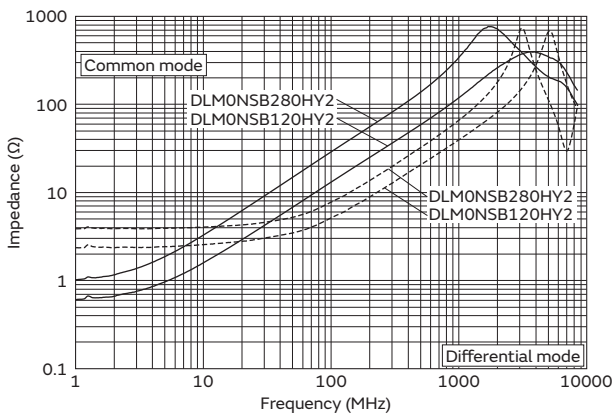

Continued on the following page. ↗

Continued from the preceding page. ↘

Z-f Characteristics: DLM0NSN_HY2 Series

Differential mode transmission characteristics: DLM0NSN_HY2series

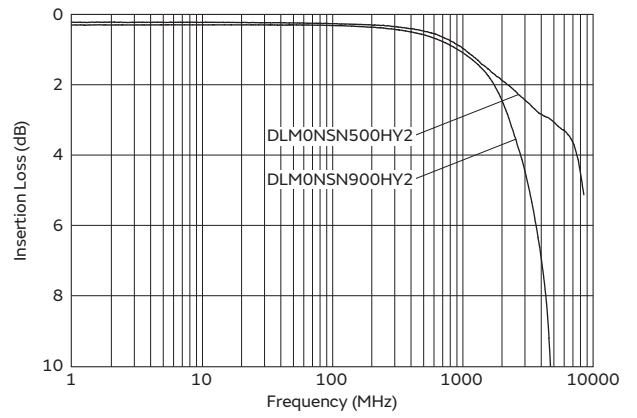
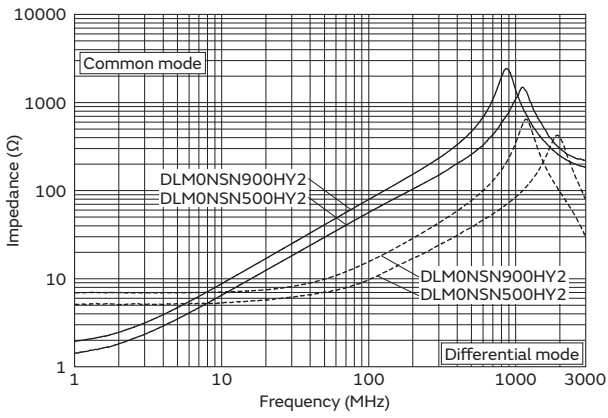

Chip Ferrite Bead

Application Specified Noise Filter

Chip EMIFIL®

Common Mode Choke Coil
 Common Mode Noise Filter

Block Type EMIFIL®

EMC Absorber

Common mode choke coil/Common mode noise filter

DLM11G Series 0504/1210(inch/mm)

Appearance/Dimensions

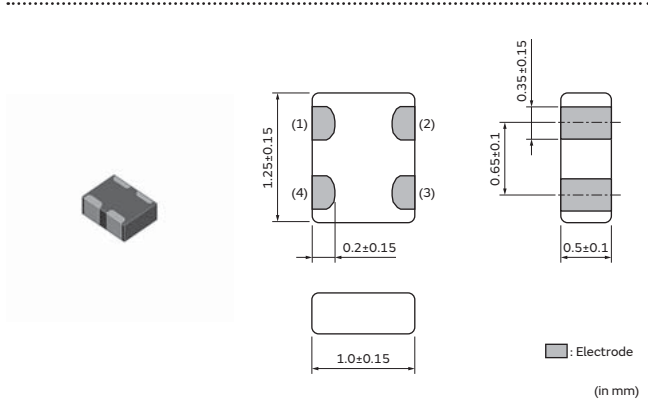

Packaging

Code	Packaging	Minimum Quantity
D	ø180mm Paper Tape	10000
B	Bulk(Bag)	1000

Equivalent Circuit

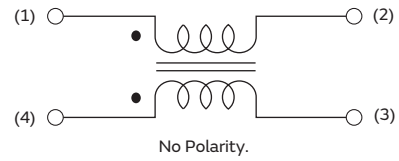

Rated Value (□: packaging code)

Part Number	Common Mode Impedance at 100MHz	Rated Current	Rated Voltage	Insulation Resistance (Min.)	Withstanding Voltage	DC Resistance	Operating Temp. Range
DLM11GN601SD2□	600Ω±25%	100mA	5Vdc	100MΩ	25Vdc	0.8Ω max.	-40°C to 85°C

Z-f Characteristics: DLM11GN_SD2 Series

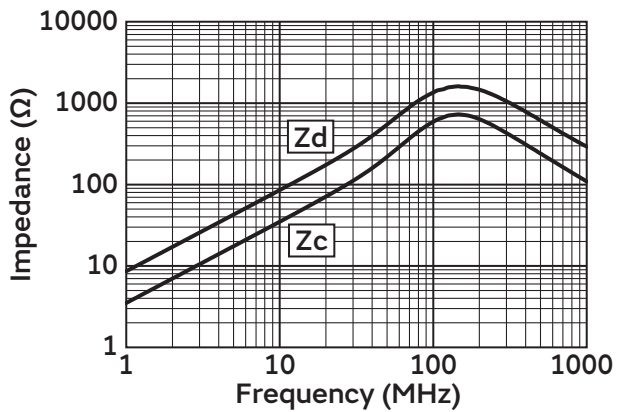

Common mode choke coil/Common mode noise filter

DLM11S Series 0504/1210(inch/mm)

Appearance/Dimensions

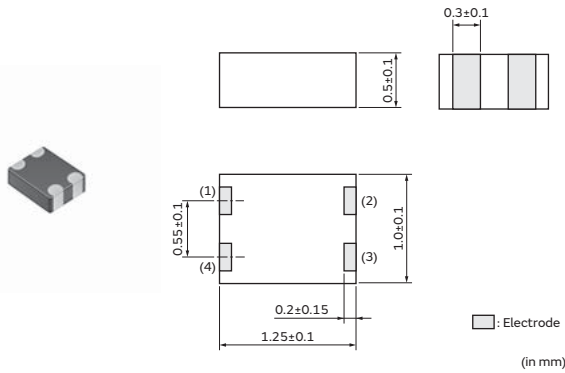

Packaging

Code	Packaging	Minimum Quantity
L	ø180mm Embossed Tape	4000
B	Bulk(Bag)	500

Equivalent Circuit

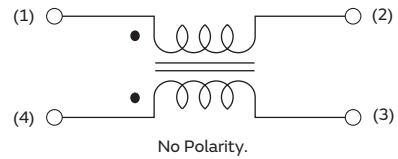

Rated Value (□: packaging code)

Part Number	Common Mode Impedance at 100MHz	Rated Current	Rated Voltage	Insulation Resistance (Min.)	Withstanding Voltage	DC Resistance
DLM11SN450HY2□	45Ω±25%	100mA	5Vdc	100MΩ	12.5Vdc	0.7Ω±25%
DLM11SN900HY2□	90Ω±25%	100mA	5Vdc	100MΩ	12.5Vdc	1.1Ω±25%

Operating Temp. Range: -40°C to 85°C

Z-f Characteristics: DLM11SN_HY2 Series

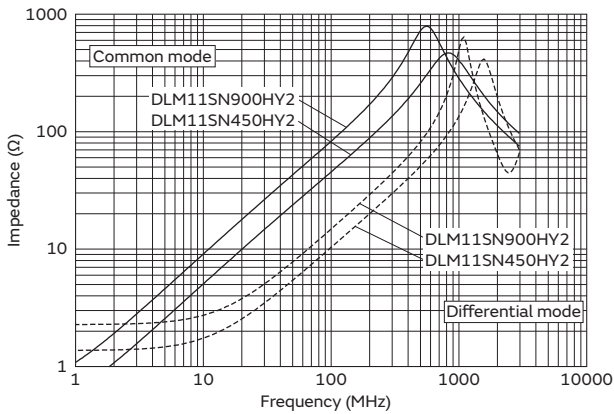

Differential mode transmission characteristics: DLM11SN_HY2series

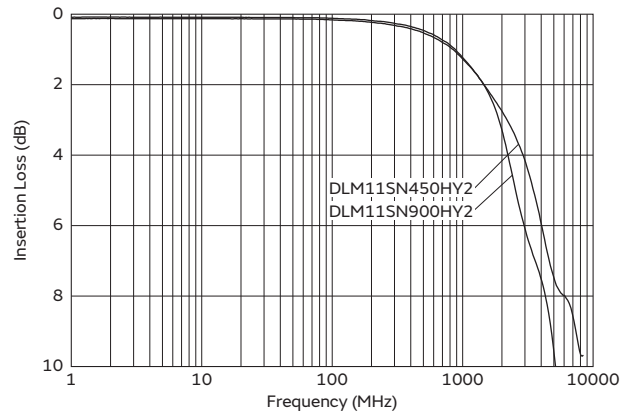

Chip Ferrite Bead

Application Specified Noise Filter

Chip EMIFIL®

Common Mode Choke Coil
 Common Mode Noise Filter

Block Type EMIFIL®

EMC Absorber

Common mode choke coil/Common mode noise filter

DLPOQS Series 025020/0605(inch/mm)

Appearance/Dimensions

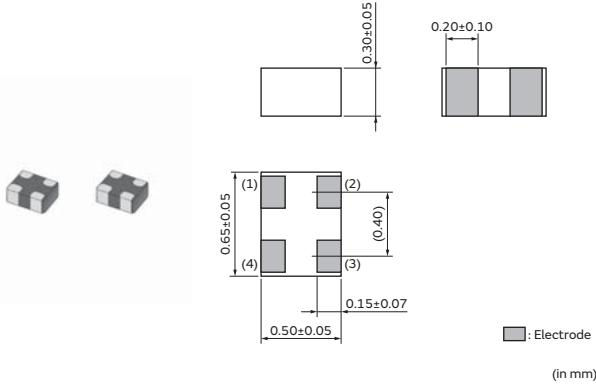

Packaging

Code	Packaging	Minimum Quantity
D	ø180mm Paper Tape	15000
B	Bulk(Bag)	500

Equivalent Circuit

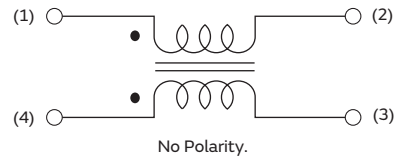

Rated Value (□: packaging code)

Part Number	Common Mode Impedance at 100MHz	Rated Current	Rated Voltage	Insulation Resistance (Min.)	Withstanding Voltage	DC Resistance
DLPOQSA070HL2□	7Ω±2Ω	100mA	5Vdc	100MΩ	12.5Vdc	0.7Ω±25%
DLPOQSA150HL2□	15Ω±5Ω	100mA	5Vdc	100MΩ	12.5Vdc	0.8Ω±25%
DLPOQSA350HL2□	35Ω±10Ω	100mA	5Vdc	100MΩ	12.5Vdc	2.2Ω±25%

Operating Temp. Range: -40°C to 85°C

Z-f Characteristics: DLPOQSA_HL2 Series

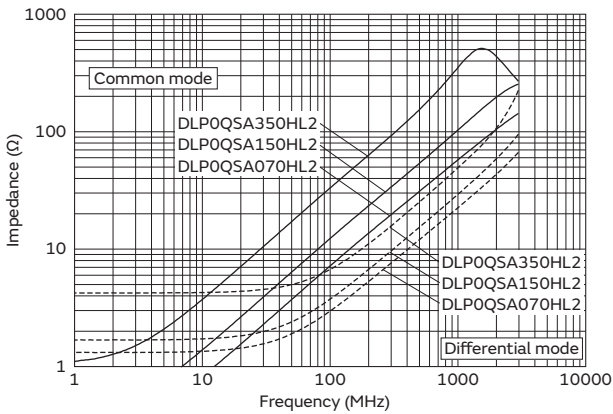

Differential mode transmission characteristics: DLPOQSA_HL2series

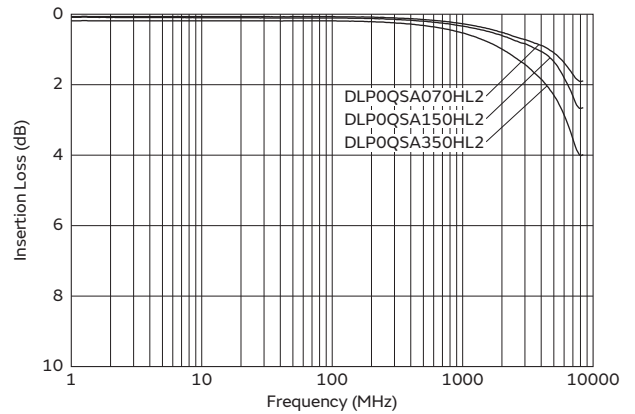

Common mode choke coil/Common mode noise filter

DLPONS Series 03025/0806(inch/mm)

Appearance/Dimensions

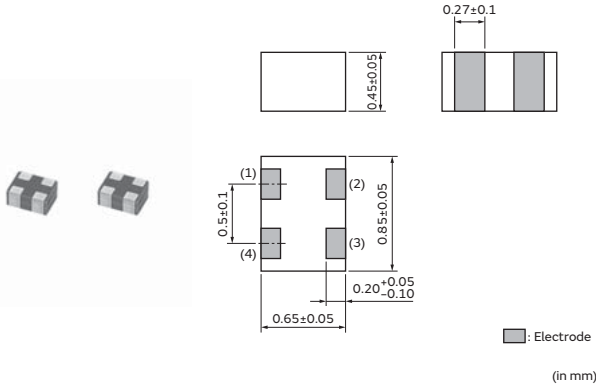

Packaging

Code	Packaging	Minimum Quantity
L	ø180mm Embossed Tape	10000
B	Bulk(Bag)	500

Equivalent Circuit

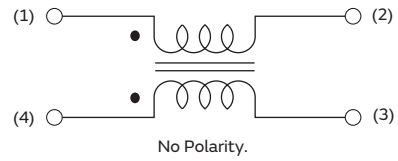

Rated Value (□: packaging code)

Part Number	Common Mode Impedance at 100MHz	Rated Current	Rated Voltage	Insulation Resistance (Min.)	Withstanding Voltage	DC Resistance
DLPONSN350HL2□	35Ω±10Ω	100mA	5Vdc	100MΩ	12.5Vdc	1.2Ω±25%
DLPONSN670HL2□	67Ω±20%	110mA	5Vdc	100MΩ	12.5Vdc	2.4Ω±25%
DLPONSN900HL2□	90Ω±20%	100mA	5Vdc	100MΩ	12.5Vdc	3.0Ω±25%
DLPONSN121HL2□	120Ω±20%	90mA	5Vdc	100MΩ	12.5Vdc	3.8Ω±25%
DLPONSA070HL2□	7Ω±2Ω	100mA	5Vdc	100MΩ	12.5Vdc	0.6Ω±25%
DLPONSA150HL2□	15Ω±5Ω	100mA	5Vdc	100MΩ	12.5Vdc	0.95Ω±25%
DLPONSC280HL2□	28Ω±20%	100mA	5Vdc	100MΩ	12.5Vdc	1.3Ω±25%
DLPONSC900HL2□	90Ω±35%	75mA	5Vdc	100MΩ	12.5Vdc	4.0Ω±30%

Operating Temp. Range: -40°C to 85°C

Z-f Characteristics: DLPONSN_HL2 Series

Differential mode transmission characteristics: DLPONSN_HL2series

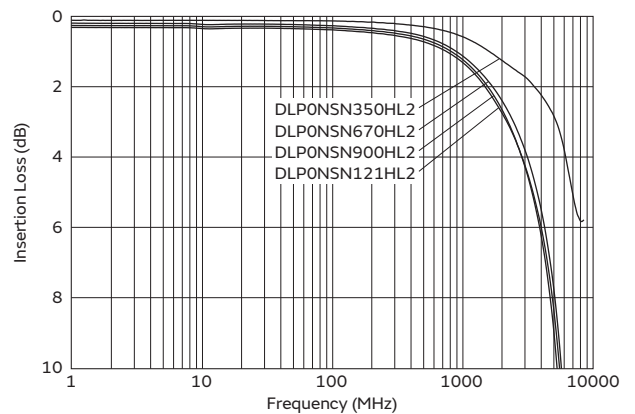
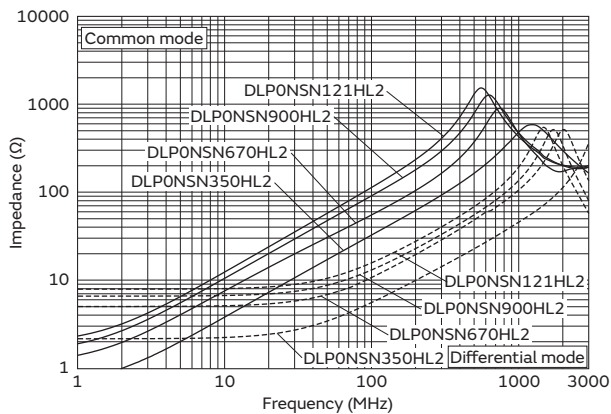

Continued on the following page. ↗

Continued from the preceding page. ↘

Z-f Characteristics: DLPONSA_HL2 Series

Differential mode transmission characteristics: DLPONSA_HL2series

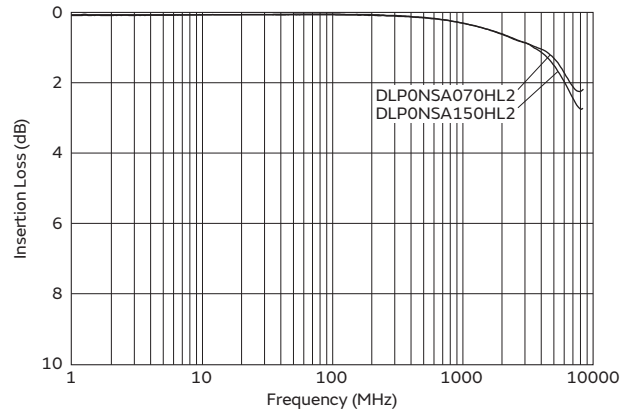
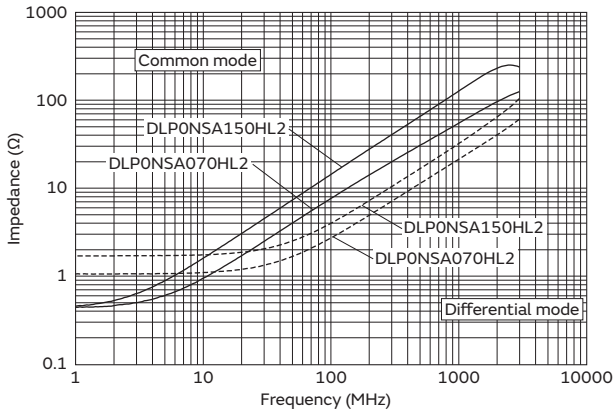

Z-f Characteristics: DLPONSC_HL2 Series

Differential mode transmission characteristics: DLPONSC_HL2series

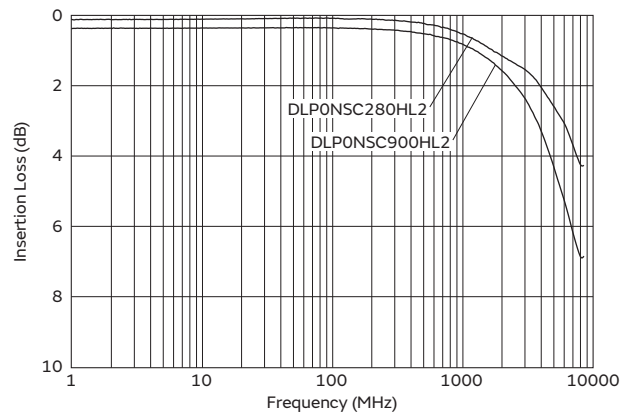
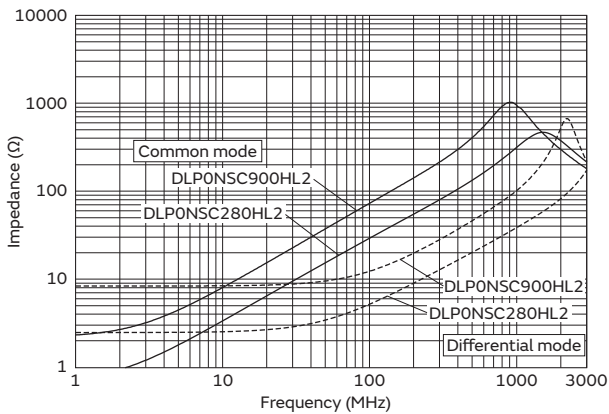

Chip Ferrite Bead

Application Specified Noise Filter

Chip EMIFIL®

Common Mode Choke Coil
 Common Mode Noise Filter

Block Type EMIFIL®

EMC Absorber

Common mode choke coil/Common mode noise filter

DLP11R Series 0504/1210(inch/mm)

Appearance/Dimensions

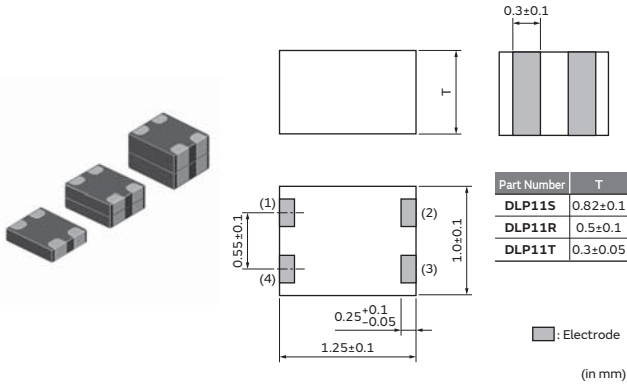

Packaging

Code	Packaging	Minimum Quantity
L	ø180mm Embossed Tape	4000
B	Bulk(Bag)	500

Equivalent Circuit

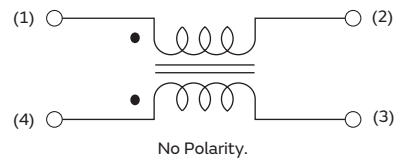

Rated Value (□: packaging code)

Part Number	Common Mode Impedance at 100MHz	Rated Current	Rated Voltage	Insulation Resistance (Min.)	Withstanding Voltage	DC Resistance
DLP11RB150UL2□	15Ω±5Ω	100mA	5Vdc	100MΩ	12.5Vdc	0.8Ω±25%
DLP11RB400UL2□	40Ω±10Ω	100mA	5Vdc	100MΩ	12.5Vdc	1.3Ω±25%
DLP11RN450UL2□	45Ω±25%	100mA	5Vdc	100MΩ	12.5Vdc	0.8Ω±25%

Operating Temp. Range: -40°C to 85°C

Z-f Characteristics: DLP11RB_UL2 Series

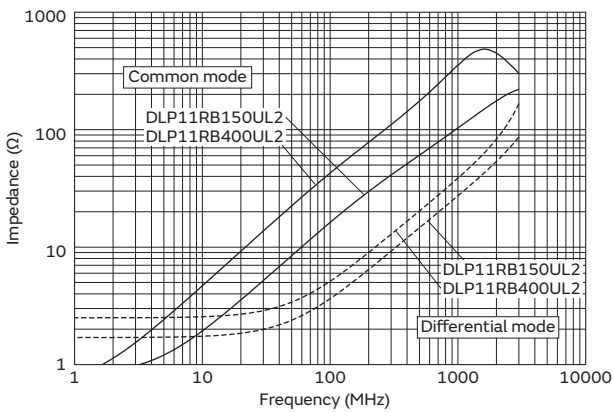

Differential mode transmission characteristics: DLP11RB_UL2series

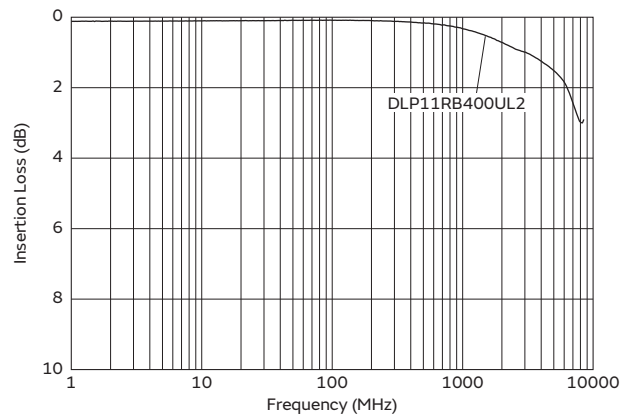

Continued on the following page. ↗

Continued from the preceding page. ↘

Z-f Characteristics: DLP11RN_UL2 Series

Differential mode transmission characteristics: DLP11RN_UL2series

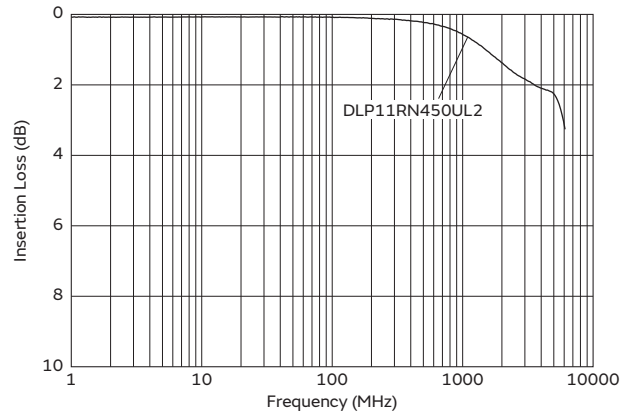
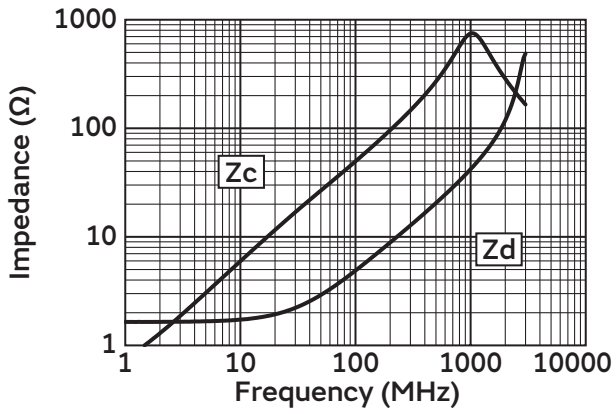

Chip Ferrite Bead

Application Specified Noise Filter

Chip EMIFIL®

Common Mode Choke Coil
 Common Mode Noise Filter

Block Type EMIFIL®

EMC Absorber

Common mode choke coil/Common mode noise filter

DLP11S Series 0504/1210(inch/mm)

Appearance/Dimensions

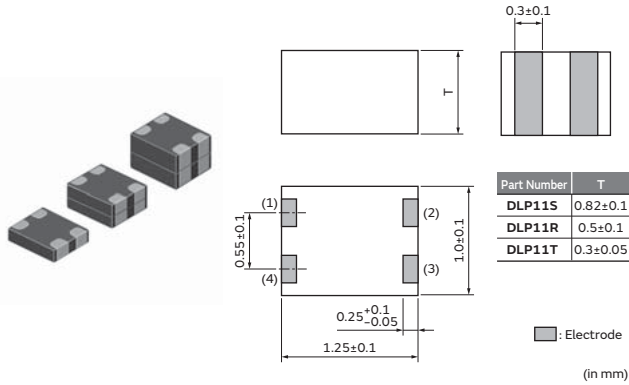

Packaging

Code	Packaging	Minimum Quantity
L	ø180mm Embossed Tape	3000
B	Bulk(Bag)	500

Equivalent Circuit

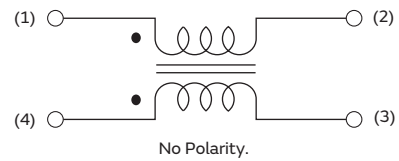

Rated Value (□: packaging code)

Part Number	Common Mode Impedance at 100MHz	Rated Current	Rated Voltage	Insulation Resistance (Min.)	Withstanding Voltage	DC Resistance
DLP11SN900HL2□	90Ω±20%	150mA	5Vdc	100MΩ	12.5Vdc	1.5Ω±25%
DLP11SN201HL2□	200Ω±20%	110mA	5Vdc	100MΩ	12.5Vdc	3.1Ω±25%
DLP11SN241HL2□	240Ω±20%	100mA	5Vdc	100MΩ	12.5Vdc	3.5Ω±25%
DLP11SN281HL2□	280Ω±20%	90mA	5Vdc	100MΩ	12.5Vdc	4.2Ω±25%
DLP11SN331HL2□	330Ω±20%	80mA	5Vdc	100MΩ	12.5Vdc	4.9Ω±25%
DLP11SN670SL2□	67Ω±20%	180mA	5Vdc	100MΩ	12.5Vdc	1.3Ω±25%
DLP11SN121SL2□	120Ω±20%	140mA	5Vdc	100MΩ	12.5Vdc	2.0Ω±25%
DLP11SN161SL2□	160Ω±20%	120mA	5Vdc	100MΩ	12.5Vdc	2.7Ω±25%
DLP11SA350HL2□	35Ω±20%	170mA	5Vdc	100MΩ	12.5Vdc	0.9Ω±25%
DLP11SA670HL2□	67Ω±20%	150mA	5Vdc	100MΩ	12.5Vdc	1.2Ω±25%
DLP11SA900HL2□	90Ω±20%	150mA	5Vdc	100MΩ	12.5Vdc	1.4Ω±25%

Operating Temp. Range: -40°C to 85°C

Z-f Characteristics: DLP11SN_HL2/SL2 Series

Differential mode transmission characteristics: DLP11SN_HL2series

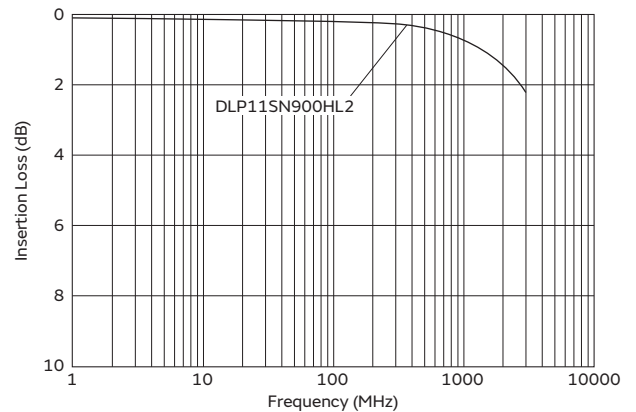
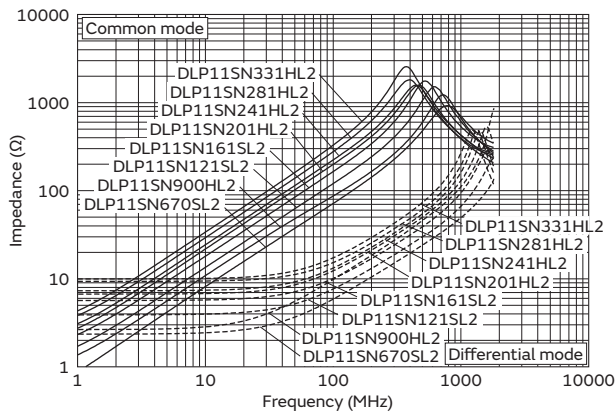

Continued on the following page. ↗

Continued from the preceding page. ↘

Z-f Characteristics: DLP11SA_HL2 Series

Differential mode transmission characteristics: DLP11SA_HL2series

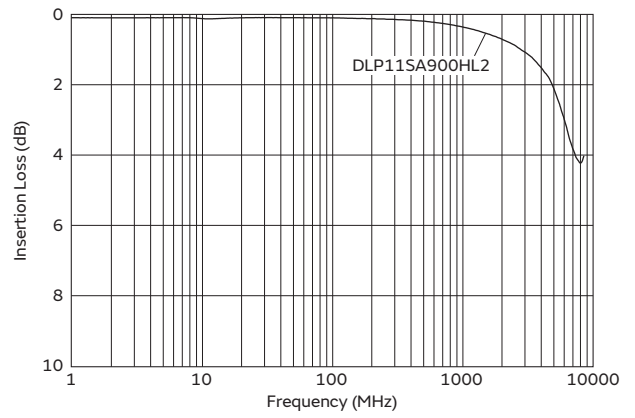
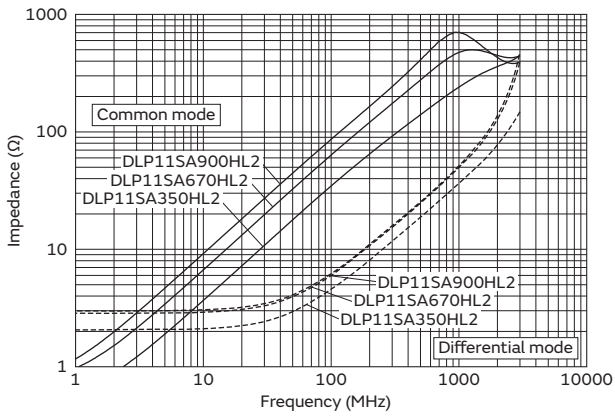

Chip Ferrite Bead

Application Specified Noise Filter

Chip EMIFIL®

Common Mode Choke Coil
 Common Mode Noise Filter

Block Type EMIFIL®

EMC Absorber

Common mode choke coil/Common mode noise filter

DLP11T Series 0504/1210(inch/mm)

Appearance/Dimensions

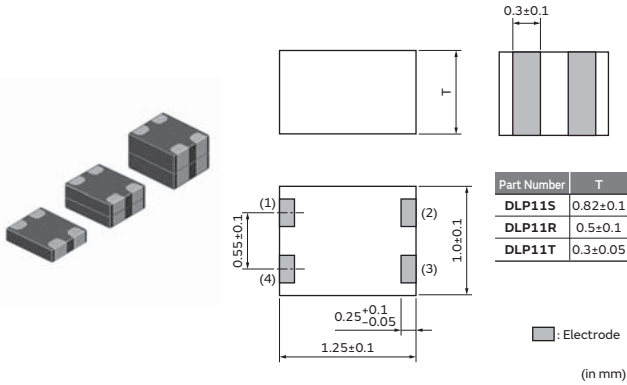

Packaging

Code	Packaging	Minimum Quantity
L	ø180mm Embossed Tape	5000
B	Bulk(Bag)	500

Equivalent Circuit

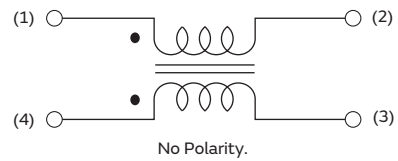

Rated Value (□: packaging code)

Part Number	Common Mode Impedance at 100MHz	Rated Current	Rated Voltage	Insulation Resistance (Min.)	Withstanding Voltage	DC Resistance	Operating Temp. Range
DLP11TB800UL2□	80Ω±25%	100mA	5Vdc	100MΩ	12.5Vdc	1.5Ω±25%	-40°C to 85°C

Z-f Characteristics: DLP11TB_UL2 Series

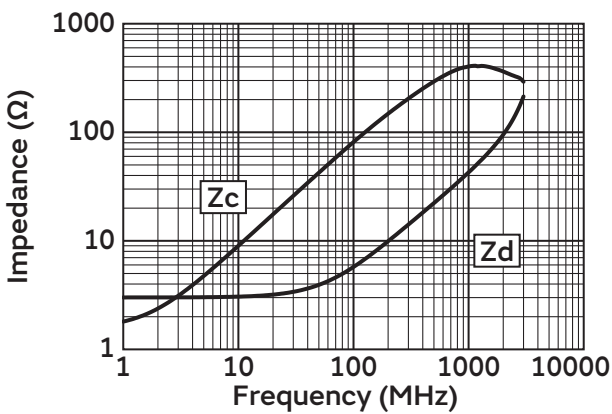

Differential mode transmission characteristics: DLP11TB_UL2series

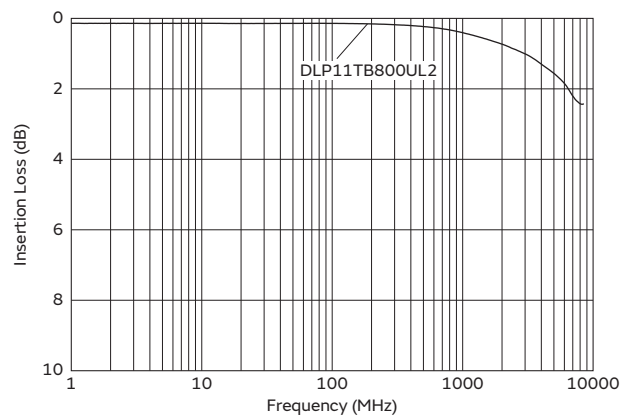

Common mode choke coil/Common mode noise filter

DLP31S Series 1206/3216(inch/mm)

Appearance/Dimensions

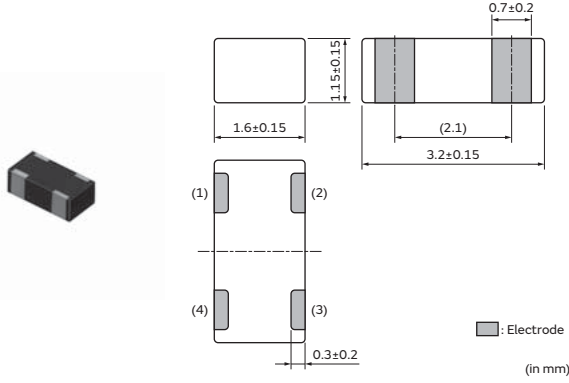

Packaging

Code	Packaging	Minimum Quantity
L	ø180mm Embossed Tape	3000
B	Bulk(Bag)	500

Equivalent Circuit

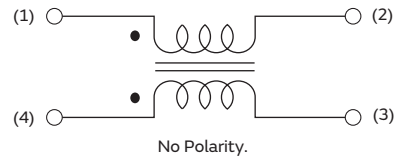

Rated Value (□: packaging code)

Part Number	Common Mode Impedance at 100MHz	Rated Current	Rated Voltage	Insulation Resistance (Min.)	Withstanding Voltage	DC Resistance
DLP31SN121ML2□	120Ω±20%	100mA	16Vdc	100MΩ	40Vdc	2.0Ω max.
DLP31SN221ML2□	220Ω±20%	100mA	16Vdc	100MΩ	40Vdc	2.5Ω max.
DLP31SN551ML2□	550Ω±20%	100mA	16Vdc	100MΩ	40Vdc	3.6Ω max.

Operating Temp. Range: -40°C to 85°C

Z-f Characteristics: DLP31SN_ML2 Series

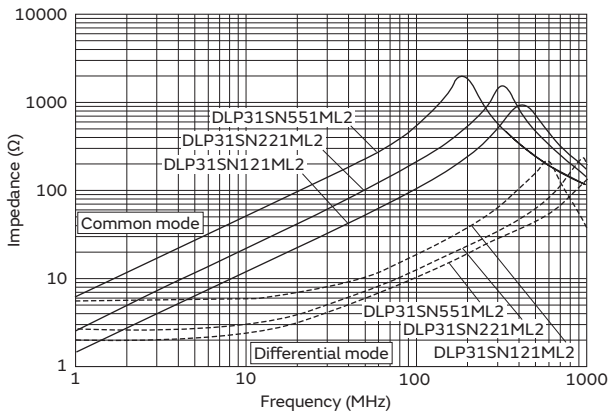

Common mode choke coil/Common mode noise filter

DLP1ND Series 05025/1506(inch/mm)

Appearance/Dimensions

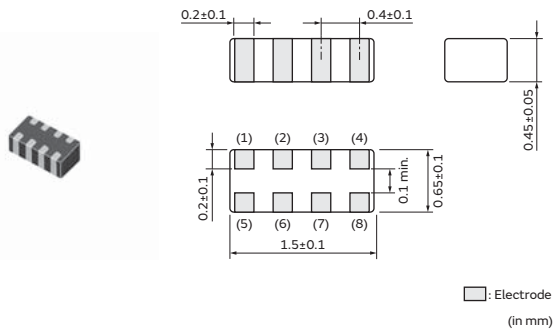

Packaging

Code	Packaging	Minimum Quantity
L	ø180mm Embossed Tape	5000
B	Bulk(Bag)	500

Equivalent Circuit

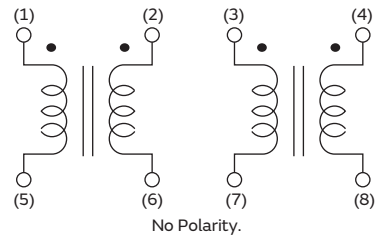

Rated Value (□: packaging code)

Part Number	Common Mode Impedance at 100MHz	Rated Current	Rated Voltage	Insulation Resistance (Min.)	Withstanding Voltage	DC Resistance
DLP1NDN350HL4□	35Ω±20%	100mA	5Vdc	100MΩ	12.5Vdc	1.8Ω±25%
DLP1NDN670HL4□	67Ω±20%	80mA	5Vdc	100MΩ	12.5Vdc	2.9Ω±25%
DLP1NDN900HL4□	90Ω±20%	60mA	5Vdc	100MΩ	12.5Vdc	3.7Ω±25%

Operating Temp. Range: -40°C to 85°C

Z-f Characteristics: DLP1NDN_HL4 Series

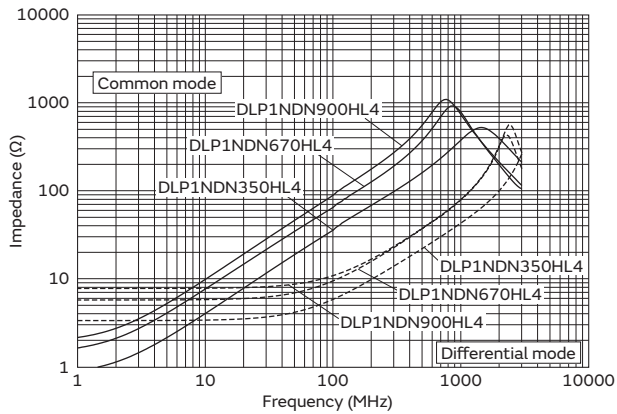

Differential mode transmission characteristics: DLP1NDN_HL4series

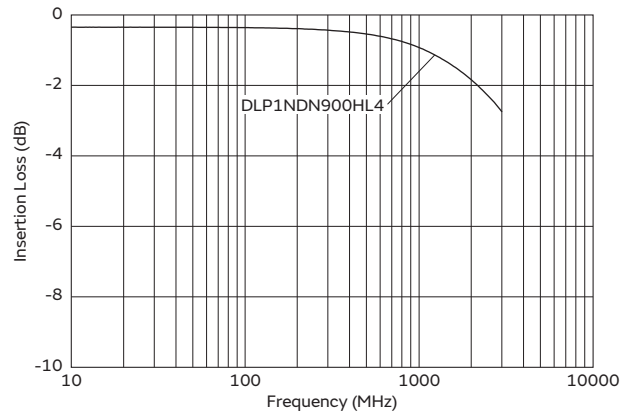

Chip Ferrite Bead

Application Specified Noise Filter

Chip EMIFIL®

Common Mode Choke Coil
 Common Mode Noise Filter

Block Type EMIFIL®

EMC Absorber

Common mode choke coil/Common mode noise filter

DLP2AD Series 0804/2010(inch/mm)

Appearance/Dimensions

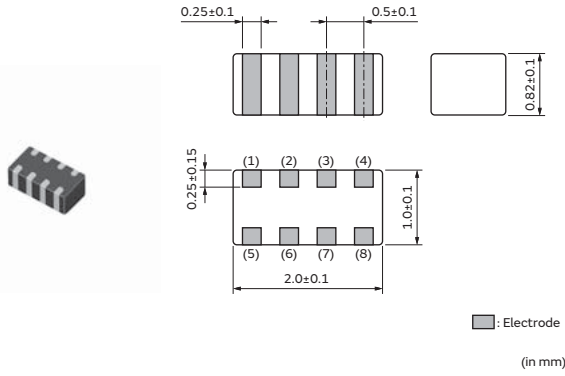

Packaging

Code	Packaging	Minimum Quantity
L	ø180mm Embossed Tape	3000
B	Bulk(Bag)	500

Equivalent Circuit

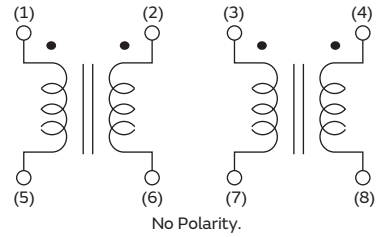

Rated Value (□: packaging code)

Part Number	Common Mode Impedance at 100MHz	Rated Current	Rated Voltage	Insulation Resistance (Min.)	Withstanding Voltage	DC Resistance
DLP2ADN670HL4□	67Ω±20%	140mA	5Vdc	100MΩ	12.5Vdc	1.3Ω±25%
DLP2ADN900HL4□	90Ω±20%	130mA	5Vdc	100MΩ	12.5Vdc	1.7Ω±25%
DLP2ADN121HL4□	120Ω±20%	120mA	5Vdc	100MΩ	12.5Vdc	2.0Ω±25%
DLP2ADN161HL4□	160Ω±20%	100mA	5Vdc	100MΩ	12.5Vdc	2.5Ω±25%
DLP2ADN201HL4□	200Ω±20%	90mA	5Vdc	100MΩ	12.5Vdc	3.2Ω±25%
DLP2ADN241HL4□	240Ω±20%	80mA	5Vdc	100MΩ	12.5Vdc	3.8Ω±25%
DLP2ADN281HL4□	280Ω±20%	80mA	5Vdc	100MΩ	12.5Vdc	4.6Ω±25%
DLP2ADA350HL4□	35Ω±20%	150mA	5Vdc	100MΩ	12.5Vdc	0.8Ω±25%
DLP2ADA670HL4□	67Ω±20%	130mA	5Vdc	100MΩ	12.5Vdc	1.0Ω±25%
DLP2ADA900HL4□	90Ω±20%	120mA	5Vdc	100MΩ	12.5Vdc	1.4Ω±25%

Operating Temp. Range: -40°C to 85°C

Z-f Characteristics: DLP2ADN_HL4 Series

Differential mode transmission characteristics: DLP2ADN_HL4series

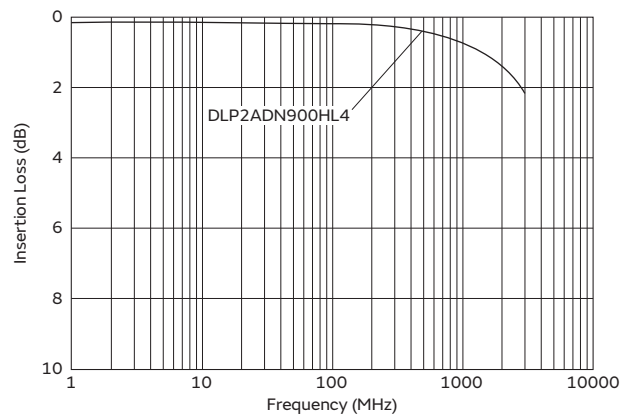
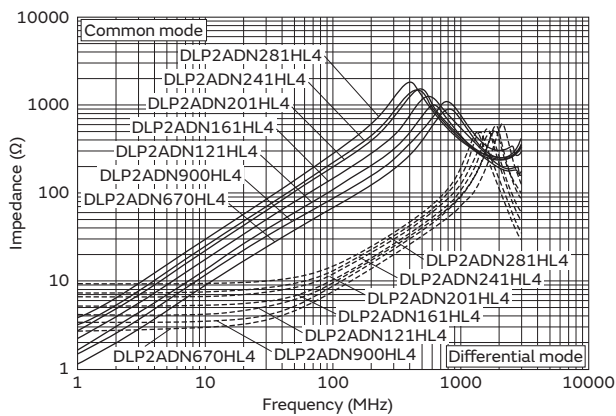

Continued on the following page. ↗

Continued from the preceding page. ↘

Z-f Characteristics: DLP2ADA_HL4 Series

Differential mode transmission characteristics: DLP2ADA_HL4series

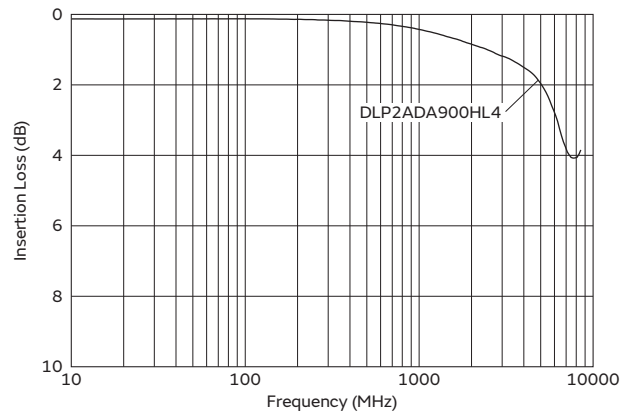
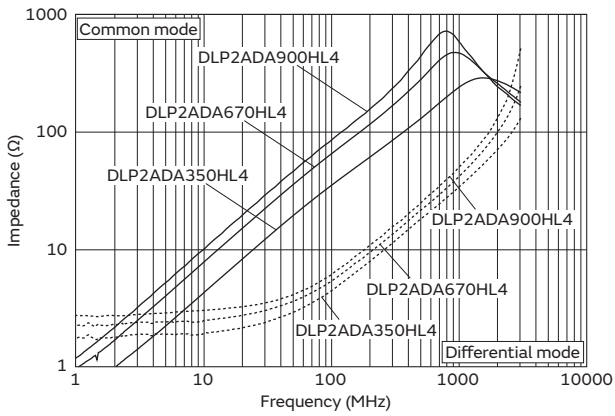

Chip Ferrite Bead

Application Specified Noise Filter

Chip EMIFIL®

Common Mode Choke Coil
 Common Mode Noise Filter

Block Type EMIFIL®

EMC Absorber

Common mode choke coil/Common mode noise filter

DLP31D Series 1206/3216(inch/mm)

Appearance/Dimensions

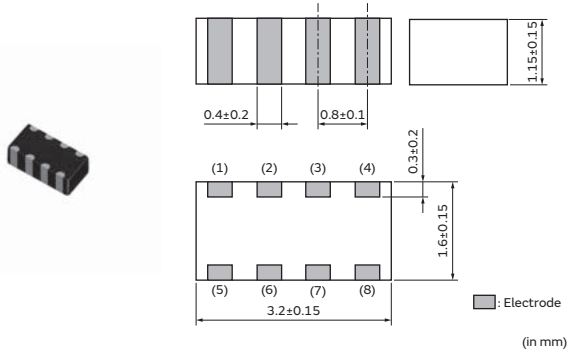

Packaging

Code	Packaging	Minimum Quantity
L	ø180mm Embossed Tape	3000
B	Bulk(Bag)	500

Equivalent Circuit

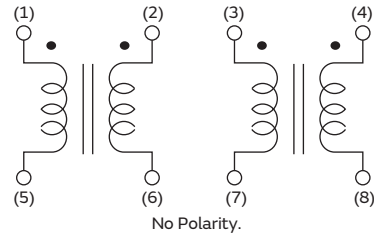

Rated Value (□: packaging code)

Part Number	Common Mode Impedance at 100MHz	Rated Current	Rated Voltage	Insulation Resistance (Min.)	Withstanding Voltage	DC Resistance
DLP31DN900ML4□	90Ω±20%	160mA	10Vdc	100MΩ	25Vdc	1.1Ω max.
DLP31DN131ML4□	130Ω±20%	120mA	10Vdc	100MΩ	25Vdc	1.6Ω max.
DLP31DN201ML4□	200Ω±20%	100mA	10Vdc	100MΩ	25Vdc	2.2Ω max.
DLP31DN321ML4□	320Ω±20%	80mA	10Vdc	100MΩ	25Vdc	3.5Ω max.
DLP31DN441ML4□	440Ω±20%	70mA	10Vdc	100MΩ	25Vdc	4.3Ω max.

Operating Temp. Range: -40°C to 85°C

Z-f Characteristics: DLP31DN_ML4 Series

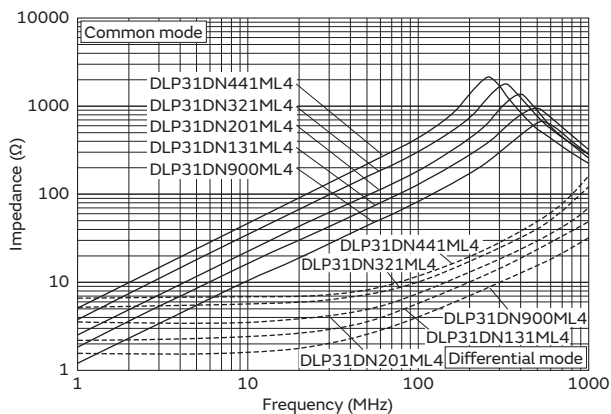

Common mode choke coil/Common mode noise filter

DLW21H Series 0805/2012(inch/mm)

Appearance/Dimensions

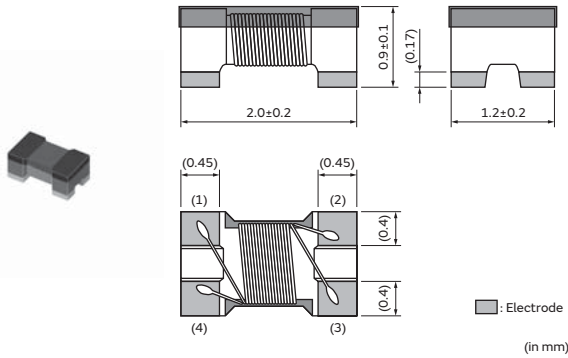

Packaging

Code	Packaging	Minimum Quantity
L	ø180mm Embossed Tape	3000
B	Bulk(Bag)	500

Equivalent Circuit

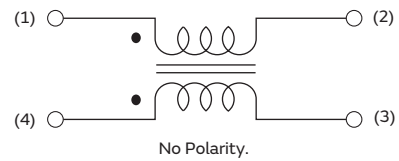

Rated Value (□: packaging code)

Part Number	Common Mode Impedance at 100MHz	Rated Current	Rated Voltage	Insulation Resistance (Min.)	Withstanding Voltage	DC Resistance
DLW21HN670SQ2□	67Ω±25%	330mA	50Vdc	10MΩ	125Vdc	0.35Ω max.
DLW21HN900SQ2□	90Ω±25%	330mA	50Vdc	10MΩ	125Vdc	0.35Ω max.
DLW21HN121SQ2□	120Ω±25%	280mA	50Vdc	10MΩ	125Vdc	0.45Ω max.
DLW21HN181SQ2□	180Ω±25%	250mA	50Vdc	10MΩ	125Vdc	0.50Ω max.
DLW21HN670HQ2□	67Ω±25%	240mA	20Vdc	10MΩ	50Vdc	0.49Ω max.
DLW21HN900HQ2□	90Ω±25%	220mA	20Vdc	10MΩ	50Vdc	0.59Ω max.
DLW21HN121HQ2□	120Ω±25%	200mA	20Vdc	10MΩ	50Vdc	0.68Ω max.

Operating Temp. Range: -40°C to 85°C

Z-f Characteristics: DLW21HN_SQ2 Series

Z-f Characteristics: DLW21HN_HQ2 Series

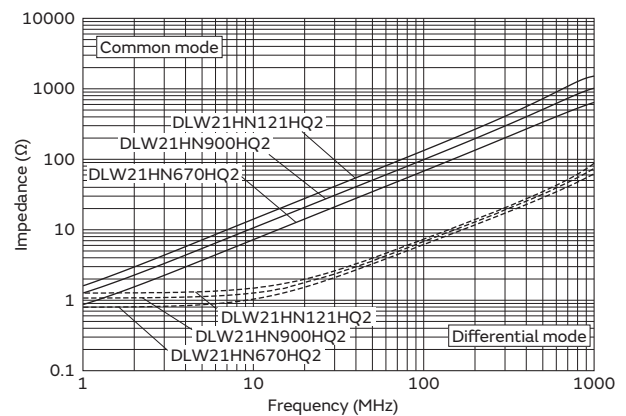
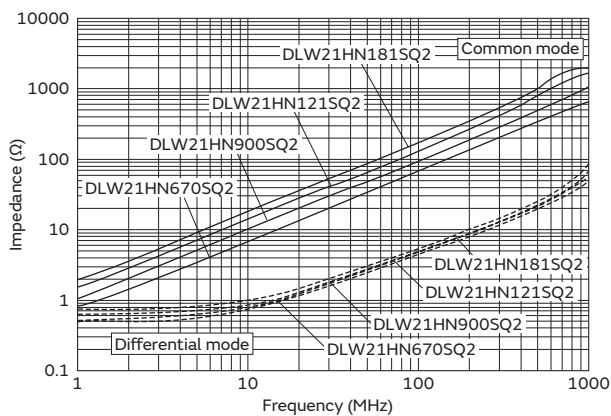

Continued on the following page. ↗

Continued from the preceding page. ↘

Differential mode transmission characteristics: DLW21HN_HQ2series

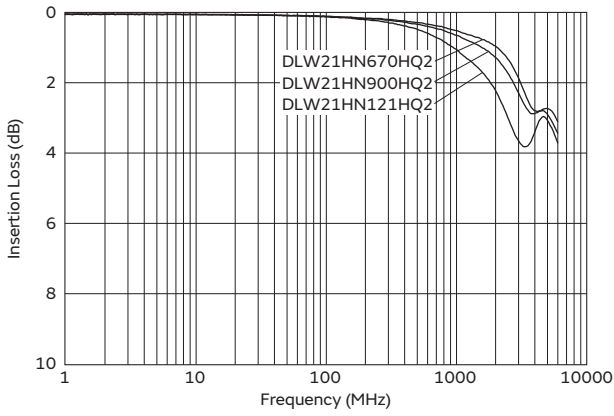

Chip Ferrite Bead

Application Specified Noise Filter

Chip EMIFIL®

Common Mode Choke Coil
Common Mode Noise Filter

Block Type EMIFIL®

EMC Absorber

Common mode choke coil/Common mode noise filter

DLW21S Series 0805/2012(inch/mm)

Appearance/Dimensions

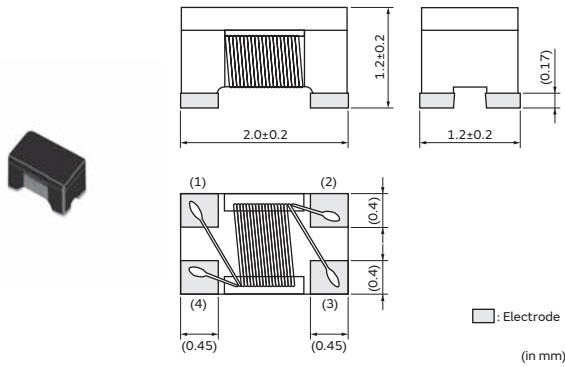

Packaging

Code	Packaging	Minimum Quantity
L	ø180mm Embossed Tape	2000
B	Bulk(Bag)	500

Equivalent Circuit

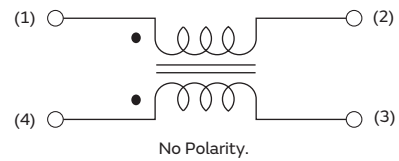

Rated Value (□: packaging code)

Part Number	Common Mode Impedance at 100MHz	Rated Current	Rated Voltage	Insulation Resistance (Min.)	Withstanding Voltage	DC Resistance
DLW21SN670SQ2□	67Ω±25%	400mA	50Vdc	10MΩ	125Vdc	0.25Ω max.
DLW21SN900SQ2□	90Ω±25%	330mA	50Vdc	10MΩ	125Vdc	0.35Ω max.
DLW21SN121SQ2□	120Ω±25%	370mA	50Vdc	10MΩ	125Vdc	0.30Ω max.
DLW21SN181SQ2□	180Ω±25%	330mA	50Vdc	10MΩ	125Vdc	0.35Ω max.
DLW21SN261SQ2□	260Ω±25%	300mA	50Vdc	10MΩ	125Vdc	0.40Ω max.
DLW21SN371SQ2□	370Ω±25%	280mA	50Vdc	10MΩ	125Vdc	0.45Ω max.
DLW21SN501SK2□	500Ω±25%	250mA	50Vdc	10MΩ	125Vdc	0.5Ω max.
DLW21SN921SK2□	920Ω±25%	160mA	50Vdc	10MΩ	125Vdc	0.95Ω max.
DLW21SN670HQ2□	67Ω±25%	320mA	20Vdc	10MΩ	50Vdc	0.31Ω max.
DLW21SN900HQ2□	90Ω±25%	280mA	20Vdc	10MΩ	50Vdc	0.41Ω max.
DLW21SN121HQ2□	120Ω±25%	280mA	20Vdc	10MΩ	50Vdc	0.41Ω max.
DLW21SN211XK2□	210Ω±25%	360mA	20Vdc	10MΩ	50Vdc	0.33Ω max.
DLW21SN181XQ2□	180Ω±25%	240mA	20Vdc	10MΩ	50Vdc	0.39Ω max.
DLW21SN261XQ2□	260Ω±25%	220mA	20Vdc	10MΩ	50Vdc	0.59Ω max.
DLW21SN491XQ2□	490Ω±25%	190mA	20Vdc	10MΩ	50Vdc	0.77Ω max.
DLW21SR670HQ2□	67Ω±25%	400mA	20Vdc	10MΩ	50Vdc	0.25Ω max.

Operating Temp. Range: -40°C to 85°C

Continued on the following page. ↗

Continued from the preceding page. ↘

Z-f Characteristics: DLW21SN_SQ2/SK2 Series

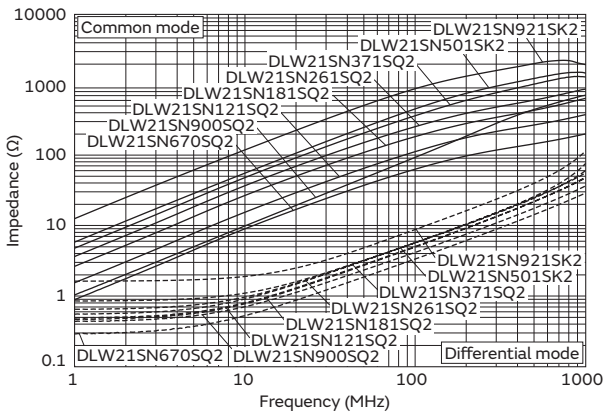

Z-f Characteristics: DLW21SN_HQ2 Series

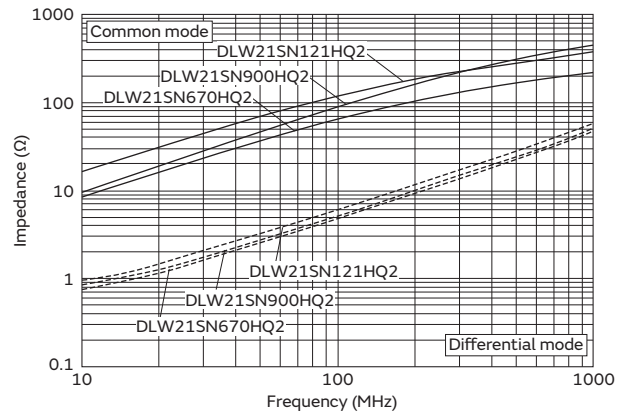

Differential mode transmission characteristics: DLW21SN_HQ2series

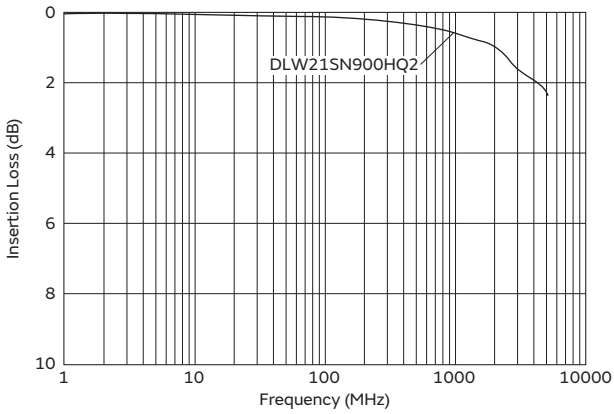

Z-f Characteristics: DLW21SN_XK2/XQ2 Series

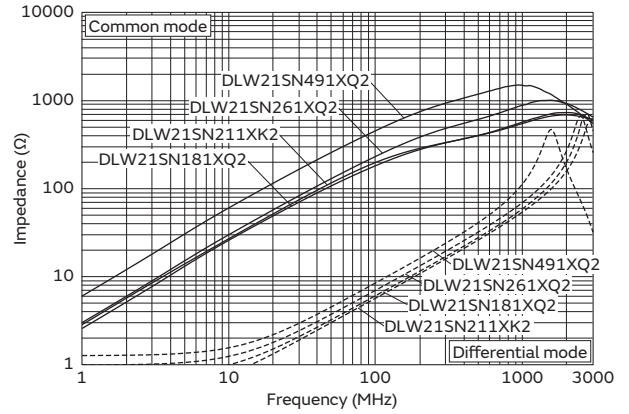

Continued on the following page. ↗

Chip Ferrite Bead

Application Specified Noise Filter

Chip EMIFIL®

Common Mode Choke Coil
 Common Mode Noise Filter

Block Type EMIFIL®

EMC Absorber

Continued from the preceding page. ↘

Differential mode transmission characteristics: DLW21SN_XK2series

Differential mode transmission characteristics: DLW21SN_XQ2series

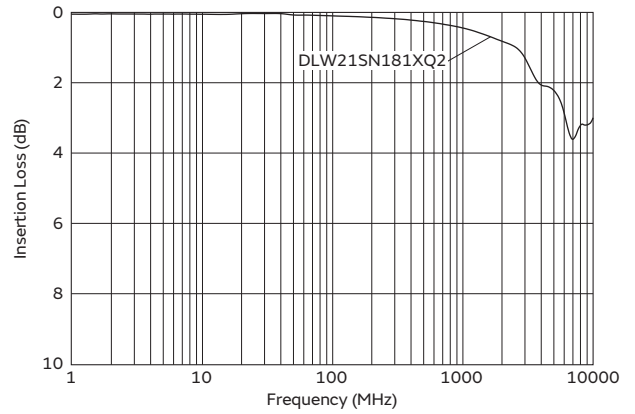
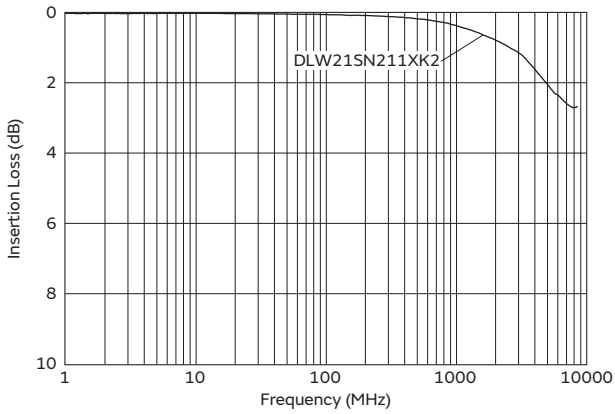

Z-f Characteristics: DLW21SR_HQ2 Series

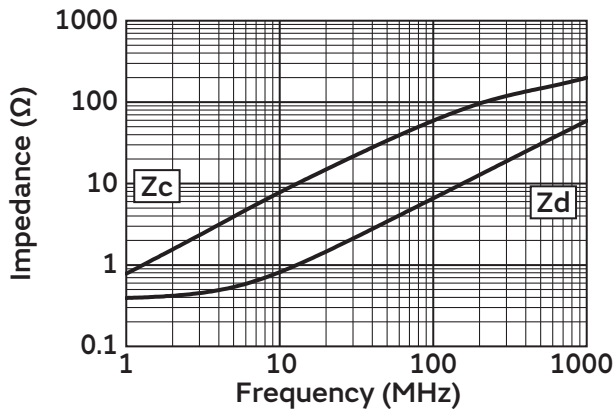

Chip Ferrite Bead

Application Specified Noise Filter

Chip EMIFIL®

Common Mode Choke Coil
 Common Mode Noise Filter

Block Type EMIFIL®

EMC Absorber

Common mode choke coil/Common mode noise filter

DLW31S Series 1206/3216(inch/mm)

Appearance/Dimensions

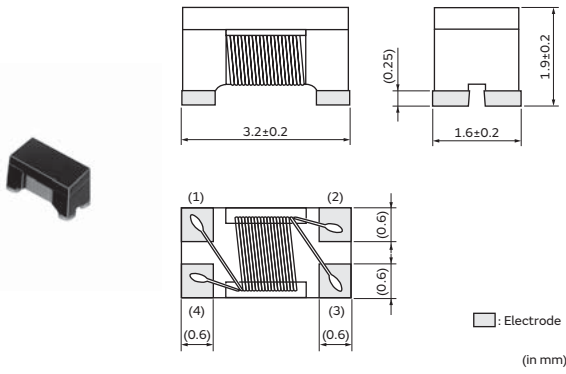

Packaging

Code	Packaging	Minimum Quantity
L	ø180mm Embossed Tape	2000
B	Bulk(Bag)	500

Equivalent Circuit

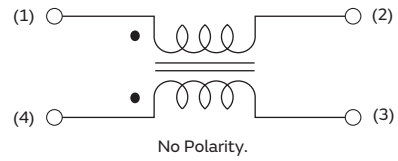

Rated Value (□: packaging code)

Part Number	Common Mode Impedance at 100MHz	Rated Current	Rated Voltage	Insulation Resistance (Min.)	Withstanding Voltage	DC Resistance
DLW31SN900SQ2□	90Ω±25%	370mA	50Vdc	10MΩ	125Vdc	0.3Ω max.
DLW31SN161SQ2□	160Ω±25%	340mA	50Vdc	10MΩ	125Vdc	0.4Ω max.
DLW31SN261SQ2□	260Ω±25%	310mA	50Vdc	10MΩ	125Vdc	0.5Ω max.
DLW31SN601SQ2□	600Ω±25%	260mA	50Vdc	10MΩ	125Vdc	0.8Ω max.
DLW31SN102SQ2□	1000Ω±25%	230mA	50Vdc	10MΩ	125Vdc	1.0Ω max.
DLW31SN222SQ2□	2200Ω±25%	200mA	50Vdc	10MΩ	125Vdc	1.2Ω max.

Operating Temp. Range: -40°C to 85°C

Z-f Characteristics: DLW31SN_SQ2 Series

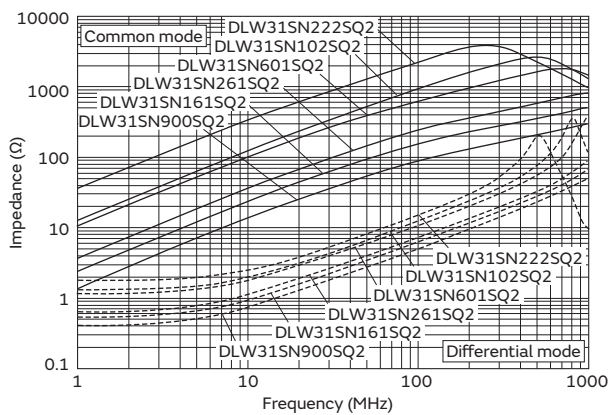

Common mode choke coil/Common mode noise filter

NFPOQ Series 025020/0605(inch/mm)

Appearance/Dimensions

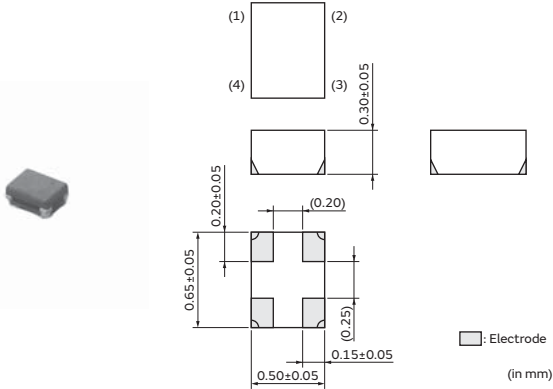

Packaging

Code	Packaging	Minimum Quantity
D	ø180mm Paper Tape	15000
B	Bulk(Bag)	500

Equivalent Circuit

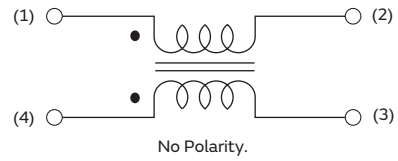

Rated Value (□: packaging code)

Part Number	Common Mode Impedance at 100MHz	Cutoff Frequency	Common Mode Insertion Loss	Rated Current	Rated Voltage	Insulation Resistance (Min.)	Withstanding Voltage	DC Resistance
NFPOQHB242HS2□	-	8.5GHz (Typ.)	27dB Typ.(2.0GHz), 43dB Typ.(2.4GHz), 23dB Typ.(3.0GHz)	100mA	5Vdc	100MΩ	12.5Vdc	1.7Ω±30%
NFPOQHB372HS2□	-	10GHz (Typ.)	15dB Typ.(2.4GHz), 40dB Typ.(3.7GHz), 15dB Typ.(6.0GHz)	100mA	5Vdc	100MΩ	12.5Vdc	2.2Ω±30%
NFPOQHB542HS2□	-	10GHz (Typ.)	30dB Typ.(5.0GHz), 40dB Typ.(5.4GHz), 25dB Typ.(6.0GHz)	100mA	5Vdc	100MΩ	12.5Vdc	1.5Ω±30%
NFPOQSB132HL2□	90Ω(Typ.)	7.5GHz (Typ.)	20dB Typ.(700MHz), 23dB Typ.(900MHz), 25dB Typ.(1.7GHz), 22dB Typ.(2.4GHz), 14dB Typ.(5.0GHz)	100mA	5Vdc	100MΩ	12.5Vdc	2.0Ω±30%

Operating Temp. Range: -40°C to 85°C

Common mode insertion loss: NFPOQHB_HS2series

Differential mode transmission characteristics: NFPOQHB_HS2series

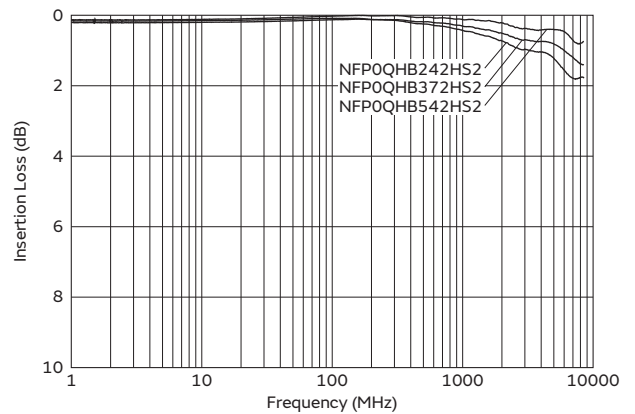
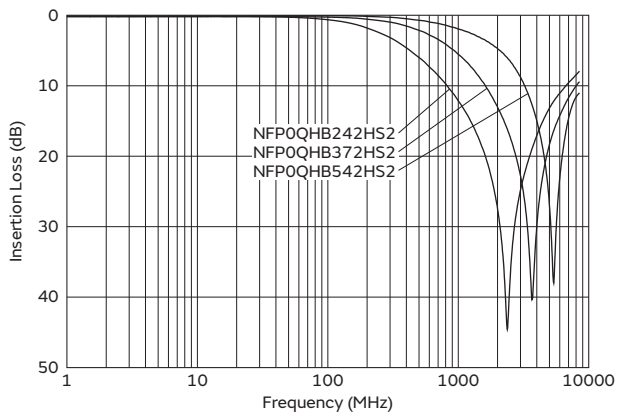

Continued on the following page. ↗

Continued from the preceding page. ↘

Common mode insertion loss: NFP0QSB_HL2series

Differential mode transmission characteristics: NFP0QSB_HL2series

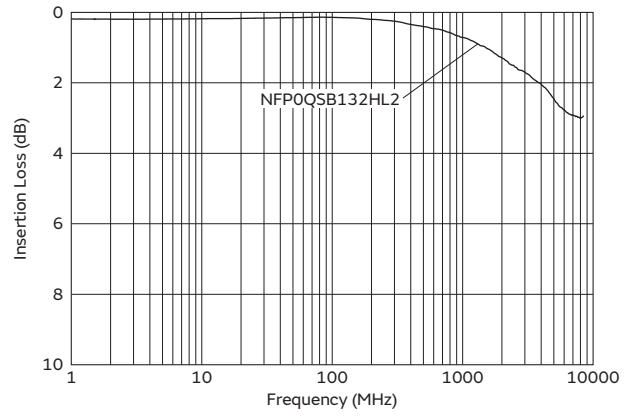
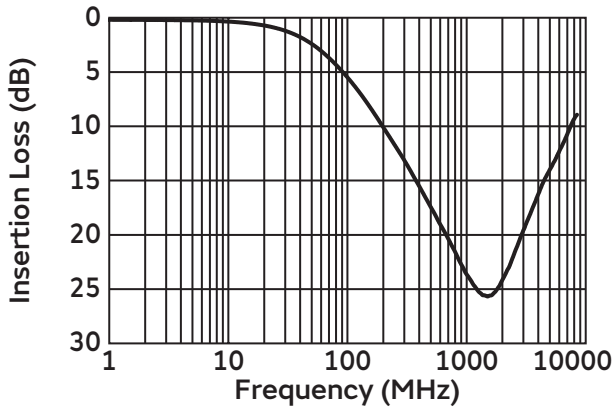

Chip Ferrite Bead

Application Specified Noise Filter

Chip EMIFIL®

Common Mode Choke Coil
 Common Mode Noise Filter

Block Type EMIFIL®

EMC Absorber

Common mode choke coil/Common mode noise filter

DLW44S Series 1515/4040(inch/mm)

Appearance/Dimensions

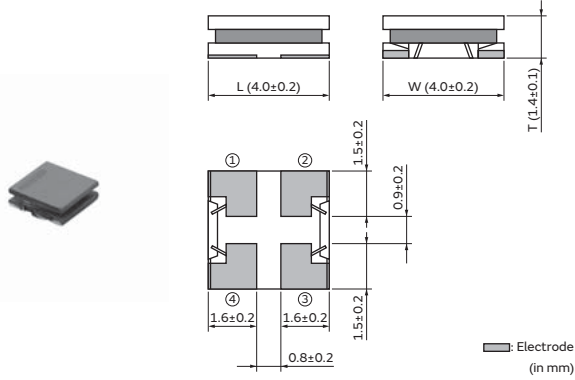

Packaging

Code	Packaging	Minimum Quantity
K	ø330mm Embossed Tape	3500
L	ø180mm Embossed Tape	1000
B	Bulk(Bag)	100

Equivalent Circuit

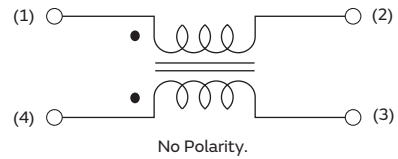

Rated Value (□: packaging code)

Part Number	Common Mode Impedance at 10MHz	Common Mode Impedance at 100MHz	Rated Current	Rated Voltage	Insulation Resistance (Min.)	Withstanding Voltage	DC Resistance
DLW44SM101SK2□	10Ω±40%	100Ω(Typ.)	3.1A	60Vdc	10MΩ	150Vdc	0.016Ω±40%
DLW44SM251SK2□	24Ω±40%	250Ω(Typ.)	2.6A	60Vdc	10MΩ	150Vdc	0.024Ω±40%
DLW44SM401SK2□	37.5Ω±40%	400Ω(Typ.)	2.1A	60Vdc	10MΩ	150Vdc	0.030Ω±40%
DLW44SM851SK2□	65Ω±40%	850Ω(Typ.)	1.9A	60Vdc	10MΩ	150Vdc	0.040Ω±40%
DLW44SM172SK2□	100Ω±40%	1700Ω(Typ.)	1.5A	60Vdc	10MΩ	150Vdc	0.060Ω±40%
DLW44SM302SK2□	180Ω±40%	2200Ω(Typ.)	1.1A	60Vdc	10MΩ	150Vdc	0.120Ω±40%
DLW44SM242SK2□	140Ω±40%	2400Ω(Typ.)	1.4A	60Vdc	10MΩ	150Vdc	0.075Ω±40%

Operating Temp. Range: -40°C to 105°C

Z-f Characteristics: DLW44SM_SK2 Series

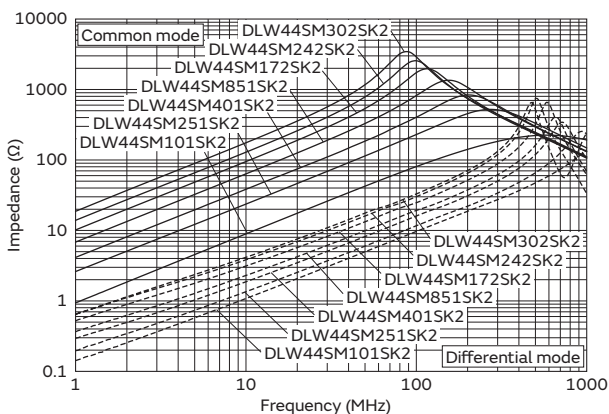

Derating of Rated Current

In operating temperature exceeding +85°C, derating of current is necessary for DLW44S series. Please apply the derating curve shown in chart according to the operating temperature.

Derating of Rated Current

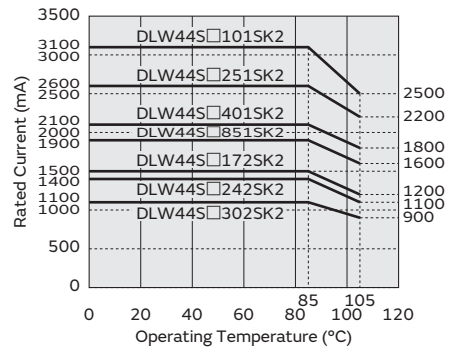

Common mode choke coil/Common mode noise filter

DLW5AH_SQ2 Series 2014/5036(inch/mm)/DLW5BS_SQ2 Series 2020/5050(inch/mm)

Appearance/Dimensions

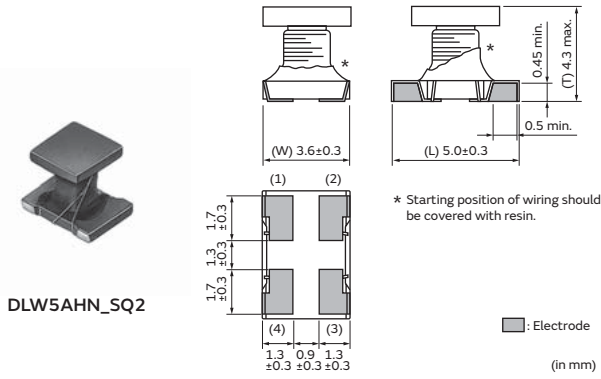

Packaging

Code	Packaging	Minimum Quantity
K	ø330mm Embossed Tape	1500
L	ø180mm Embossed Tape	400
B	Bulk(Bag)	100

Equivalent Circuit

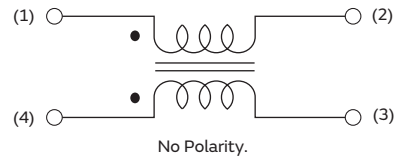

Appearance/Dimensions

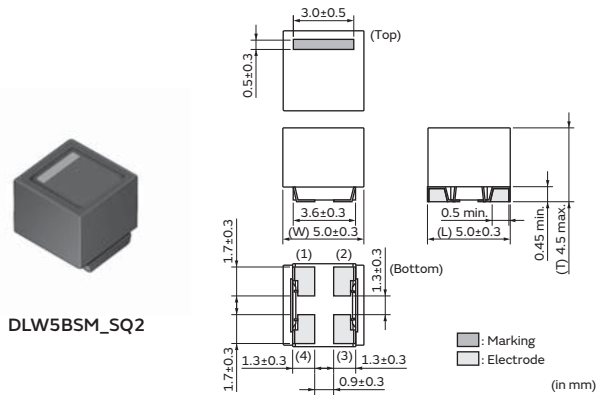

Packaging

Code	Packaging	Minimum Quantity
K	ø330mm Embossed Tape	1500
L	ø180mm Embossed Tape	400
B	Bulk(Bag)	100

Equivalent Circuit

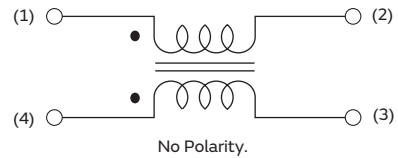

Rated Value (□: packaging code)

Part Number	Common Mode Impedance at 10MHz	Common Mode Impedance at 100MHz	Rated Current	Rated Voltage	Insulation Resistance (Min.)	Withstanding Voltage	DC Resistance	Operating Temp. Range
DLW5AHN402SQ2□	300Ωmin.	4000Ω(Typ.)	200mA	50Vdc	10MΩ	125Vdc	3.0Ω max.	-25°C to 85°C
DLW5BSM191SQ2□	19Ωmin.	190Ω(Typ.)	5A	50Vdc	10MΩ	125Vdc	0.02Ω max.	-40°C to 85°C
DLW5BSM351SQ2□	50Ωmin.	350Ω(Typ.)	2A	50Vdc	10MΩ	125Vdc	0.04Ω max.	-40°C to 85°C
DLW5BSM102SQ2□	100Ωmin.	1000Ω(Typ.)	1.5A	50Vdc	10MΩ	125Vdc	0.06Ω max.	-40°C to 85°C
DLW5BSM152SQ2□	150Ωmin.	1500Ω(Typ.)	1A	50Vdc	10MΩ	125Vdc	0.1Ω max.	-40°C to 85°C
DLW5BSM302SQ2□	300Ωmin.	3000Ω(Typ.)	500mA	50Vdc	10MΩ	125Vdc	0.3Ω max.	-40°C to 85°C

Continued on the following page. ↗

Continued from the preceding page. ↘

Z-f Characteristics: DLW5AH_SQ2/DLW5BS_SQ2 Series

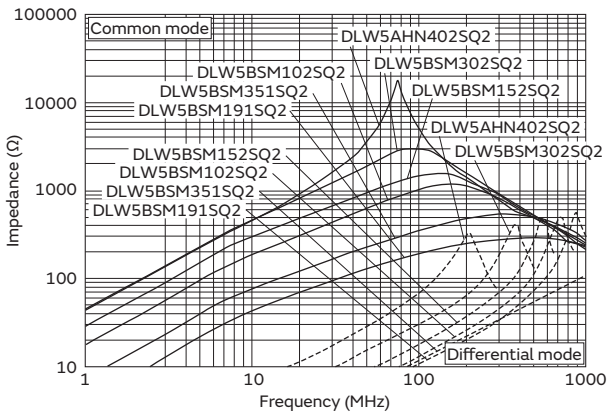

Derating of Rated Current

In operating temperature exceeding +75°C, derating of current is necessary for DLW5BSM191SQ2. Please apply the derating curve shown in chart according to the operating temperature.

Derating of Rated Current

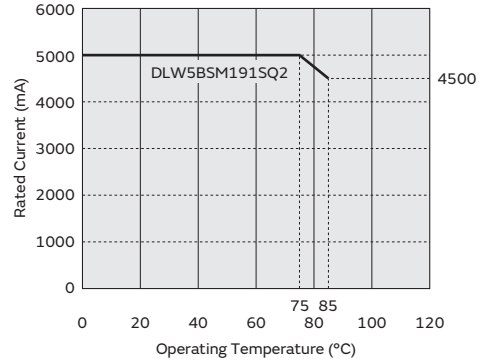

Chip Ferrite Bead

Application Specified Noise Filter

Chip EMIFIL®

Common Mode Choke Coil
 Common Mode Noise Filter

Block Type EMIFIL®

EMC Absorber

Common mode choke coil/Common mode noise filter

DLW5AT_SQ2 Series 2014/5036(inch/mm)

Appearance/Dimensions

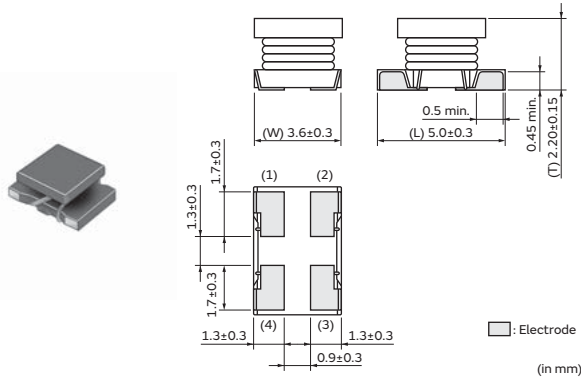

Packaging

Code	Packaging	Minimum Quantity
K	ø330mm Embossed Tape	2500
L	ø180mm Embossed Tape	700
B	Bulk(Bag)	100

Equivalent Circuit

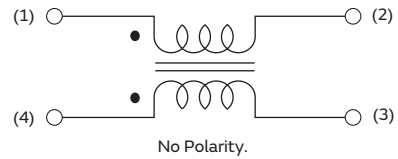

Rated Value (□: packaging code)

Part Number	Common Mode Impedance at 10MHz	Common Mode Impedance at 100MHz	Rated Current	Rated Voltage	Insulation Resistance (Min.)	Withstanding Voltage	DC Resistance
DLW5ATN111SQ2□	12Ω±25%	110Ω(Typ.)	5A	50Vdc	10MΩ	125Vdc	0.020Ω max.
DLW5ATN401SQ2□	35Ω±25%	400Ω(Typ.)	2A	50Vdc	10MΩ	125Vdc	0.034Ω max.
DLW5ATN501SQ2□	55Ω±25%	500Ω(Typ.)	1.5A	50Vdc	10MΩ	125Vdc	0.056Ω max.
DLW5ATN851SQ2□	60Ω±25%	850Ω(Typ.)	1.5A	50Vdc	10MΩ	125Vdc	0.073Ω max.
DLW5ATN272SQ2□	100Ω±25%	2700Ω(Typ.)	1A	50Vdc	10MΩ	125Vdc	0.12Ω max.

Operating Temp. Range: -40°C to 85°C

Z-f Characteristics: DLW5ATN_SQ2 Series

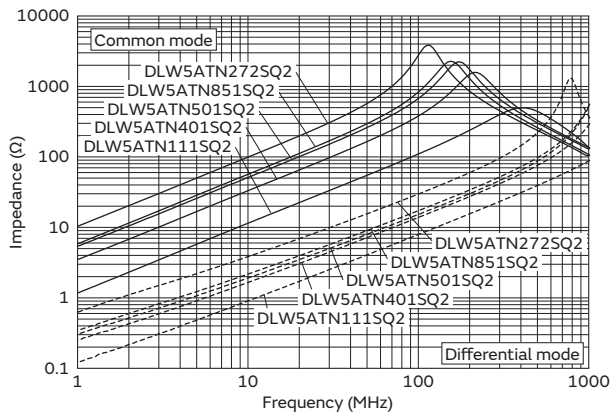

Derating of Rated Current

In operating temperature exceeding +60°C, derating of current is necessary for DLW5AT series. Please apply the derating curve shown in chart according to the operating temperature.

Derating of Rated Current

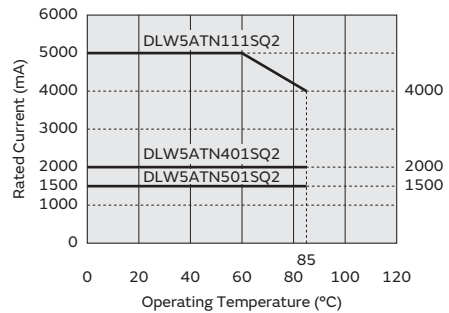

Continued on the following page. ↗

Continued from the preceding page. ↘

Derating of Rated Current

In operating temperature exceeding +75°C, derating of current is necessary for DLW5AT series.
Please apply the derating curve shown in chart according to the operating temperature.

Derating of Rated Current

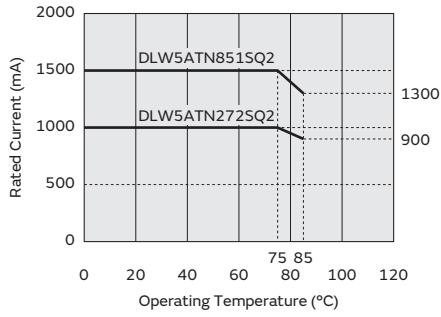

Common mode choke coil/Common mode noise filter

DLW5AT_MQ2 Series 2014/5036(inch/mm)

Appearance/Dimensions

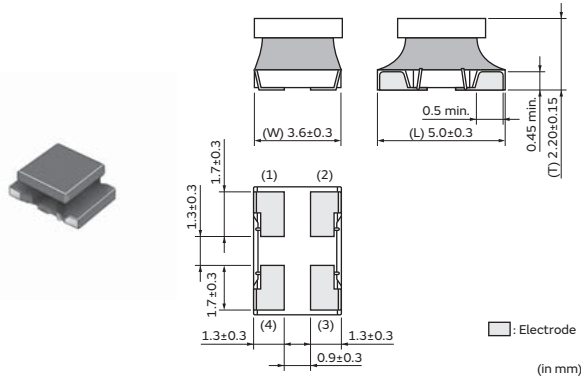

Packaging

Code	Packaging	Minimum Quantity
K	ø330mm Embossed Tape	2500
L	ø180mm Embossed Tape	700
B	Bulk(Bag)	100

Equivalent Circuit

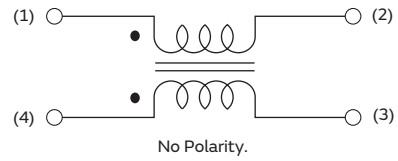

Rated Value (□: packaging code)

Part Number	Common Mode Impedance at 10MHz	Common Mode Impedance at 100MHz	Rated Current	Rated Voltage	Insulation Resistance (Min.)	Withstanding Voltage	DC Resistance
DLW5ATN500MQ2□	4.6Ωmin.	50Ω(Typ.)	6A	50Vdc	10MΩ	125Vdc	0.013Ω max.
DLW5ATN151MQ2□	11Ωmin.	150Ω(Typ.)	5A	50Vdc	10MΩ	125Vdc	0.020Ω max.
DLW5ATN331MQ2□	20Ωmin.	330Ω(Typ.)	4A	50Vdc	10MΩ	125Vdc	0.027Ω max.
DLW5ATN501MQ2□	35Ωmin.	500Ω(Typ.)	2.5A	50Vdc	10MΩ	125Vdc	0.034Ω max.
DLW5ATN112MQ2□	50Ωmin.	1100Ω(Typ.)	2A	50Vdc	10MΩ	125Vdc	0.056Ω max.

Operating Temp. Range: -40°C to 105°C

Z-f Characteristics: DLW5ATN_MQ2 Series

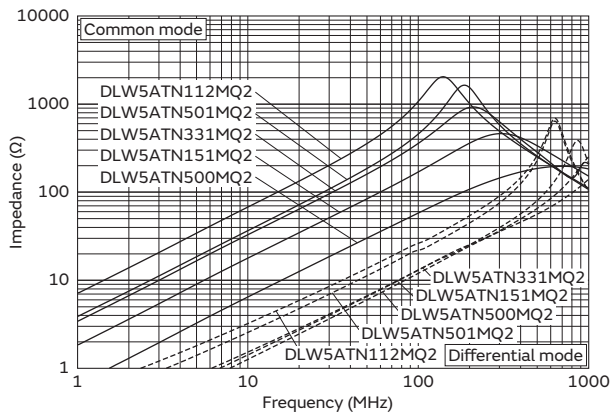

Derating of Rated Current

In operating temperature exceeding +85°C, derating of current is necessary for DLW5AT series (105 degree C available type). Please apply the derating curve shown in chart according to the operating temperature.

Derating of Rated Current

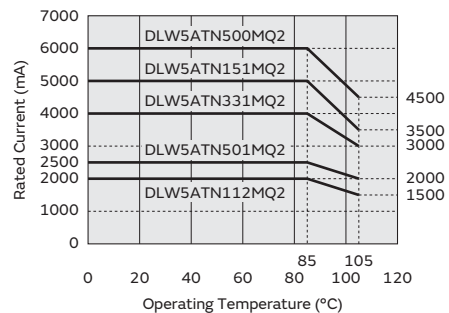

Common mode choke coil/Common mode noise filter

DLW5AT_TQ2 Series 2014/5036(inch/mm)

Appearance/Dimensions

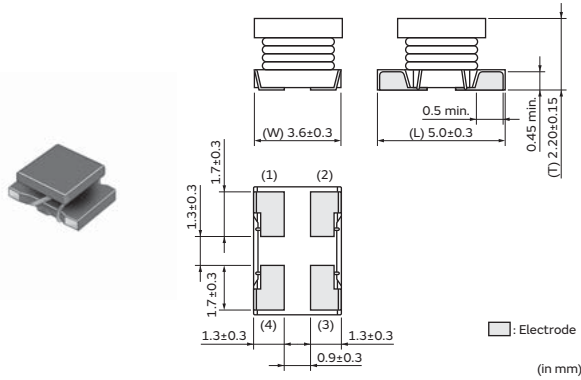

Packaging

Code	Packaging	Minimum Quantity
K	ø330mm Embossed Tape	2500
L	ø180mm Embossed Tape	700
B	Bulk(Bag)	100

Equivalent Circuit

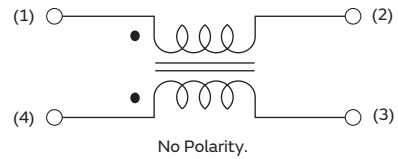

Rated Value (□: packaging code)

Part Number	Common Mode Impedance at 10MHz	Common Mode Impedance at 100MHz	Rated Current	Rated Voltage	Insulation Resistance (Min.)	Withstanding Voltage	DC Resistance
DLW5ATN111TQ2□	12Ω±25%	110Ω(Typ.)	5A	50Vdc	10MΩ	125Vdc	0.020Ω max.
DLW5ATN231TQ2□	22Ω±25%	230Ω(Typ.)	4A	50Vdc	10MΩ	125Vdc	0.027Ω max.
DLW5ATN401TQ2□	35Ω±25%	400Ω(Typ.)	2.5A	50Vdc	10MΩ	125Vdc	0.034Ω max.
DLW5ATN501TQ2□	55Ω±25%	500Ω(Typ.)	2A	50Vdc	10MΩ	125Vdc	0.056Ω max.

Operating Temp. Range: -40°C to 105°C

Z-f Characteristics: DLW5ATN_TQ2 Series

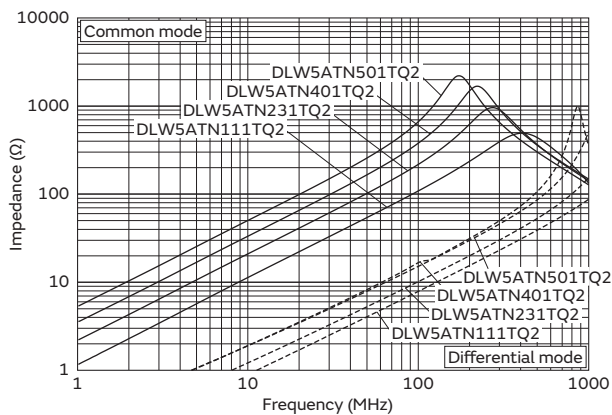

Derating of Rated Current

In operating temperature exceeding +85°C, derating of current is necessary for DLW5AT series (105 degree C available type). Please apply the derating curve shown in chart according to the operating temperature.

Derating of Rated Current

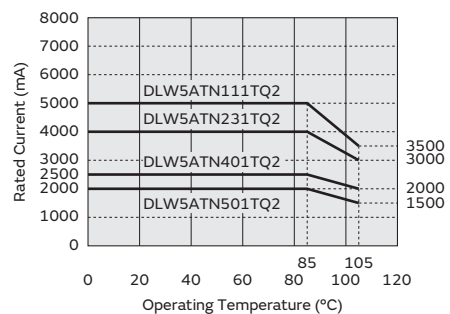

Common mode choke coil/Common mode noise filter

DLW5BS_TQ2 Series 2020/5050(inch/mm)

Appearance/Dimensions

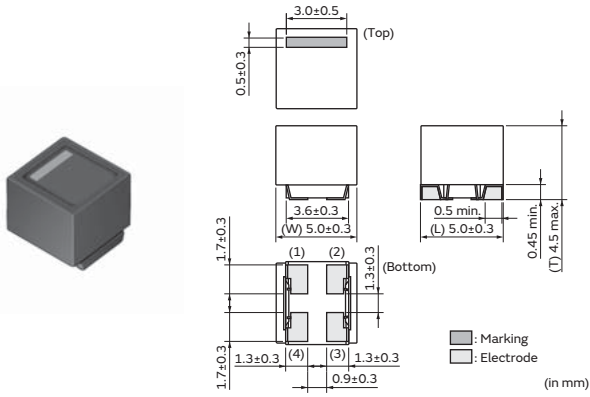

Packaging

Code	Packaging	Minimum Quantity
K	ø330mm Embossed Tape	1500
L	ø180mm Embossed Tape	400
B	Bulk(Bag)	100

Equivalent Circuit

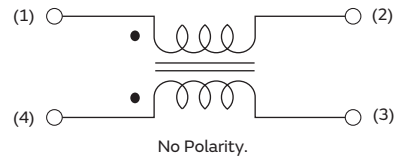

Rated Value (□: packaging code)

Part Number	Common Mode Impedance at 10MHz	Common Mode Impedance at 100MHz	Rated Current	Rated Voltage	Insulation Resistance (Min.)	Withstanding Voltage	DC Resistance
DLW5BSM501TQ2□	2800Ω±40%	500Ω(Typ.)	1A	50Vdc	10MΩ	125Vdc	0.23Ω max.
DLW5BSM601TQ2□	1200Ω±40%	600Ω(Typ.)	1.4A	50Vdc	10MΩ	125Vdc	0.12Ω max.
DLW5BSM801TQ2□	550Ω±40%	800Ω(Typ.)	2A	50Vdc	10MΩ	125Vdc	0.056Ω max.

Operating Temp. Range: -40°C to 105°C

Z-f Characteristics: DLW5BSM_TQ2 Series

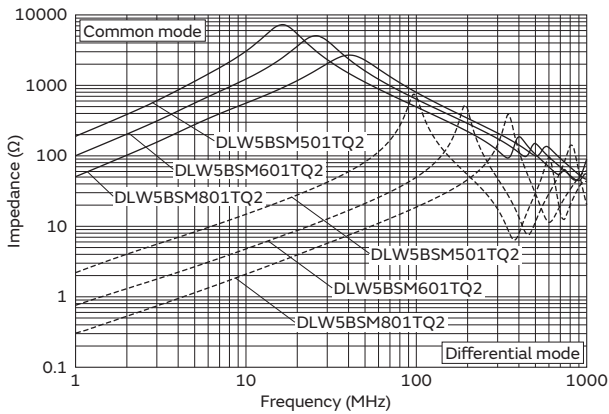

Derating of Rated Current

In operating temperature exceeding +65°C, derating of current is necessary for DLW5BS_TQ2 series. Please apply the derating curve shown in chart according to the operating temperature.

Derating of Rated Current

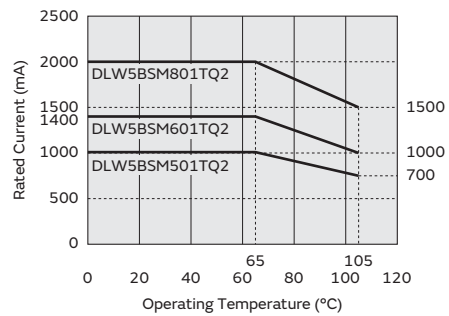

Common mode choke coil/Common mode noise filter

DLW5BT_SQ2 Series 2020/5050(inch/mm)

Appearance/Dimensions

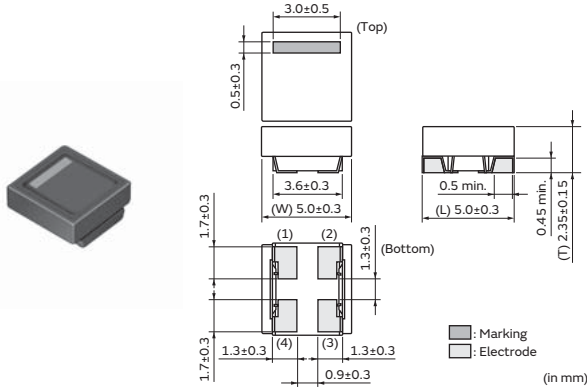

Packaging

Code	Packaging	Minimum Quantity
K	ø330mm Embossed Tape	2500
L	ø180mm Embossed Tape	700
B	Bulk(Bag)	100

Equivalent Circuit

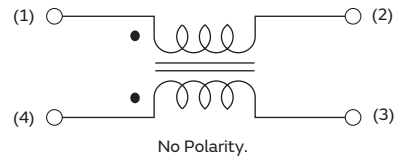

Rated Value (□: packaging code)

Part Number	Common Mode Impedance at 10MHz	Common Mode Impedance at 100MHz	Rated Current	Rated Voltage	Insulation Resistance (Min.)	Withstanding Voltage	DC Resistance
DLW5BTM101SQ2□	10Ωmin.	100Ω(Typ.)	6A	50Vdc	10MΩ	125Vdc	0.013Ω max.
DLW5BTM251SQ2□	20Ωmin.	250Ω(Typ.)	5A	50Vdc	10MΩ	125Vdc	0.020Ω max.
DLW5BTM501SQ2□	30Ωmin.	500Ω(Typ.)	4A	50Vdc	10MΩ	125Vdc	0.027Ω max.
DLW5BTM102SQ2□	60Ωmin.	1000Ω(Typ.)	2A	50Vdc	10MΩ	125Vdc	0.034Ω max.
DLW5BTM142SQ2□	100Ωmin.	1400Ω(Typ.)	1.5A	50Vdc	10MΩ	125Vdc	0.056Ω max.

Operating Temp. Range: -40°C to 85°C

Z-f Characteristics: DLW5BTM_SQ2 Series

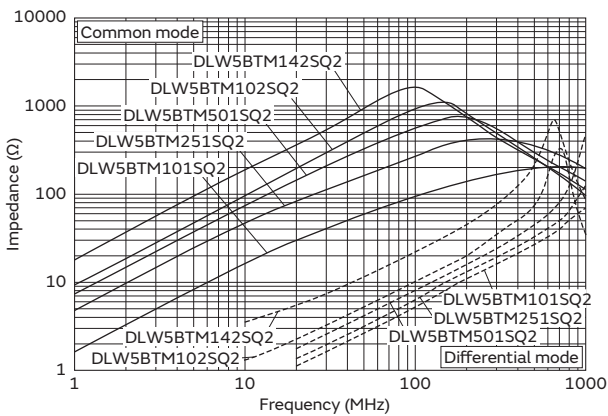

Derating of Rated Current

In operating temperature exceeding +60°C, derating of current is necessary for the following part name of DLW5BT series. Please apply the derating curve shown in chart according to the operating temperature.

Derating of Rated Current

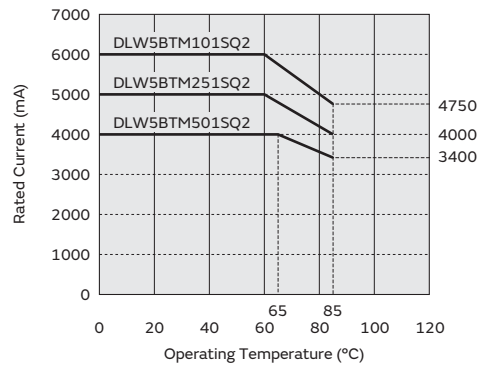

Common mode choke coil/Common mode noise filter

DLW5BT_TQ2 Series 2020/5050(inch/mm)

Appearance/Dimensions

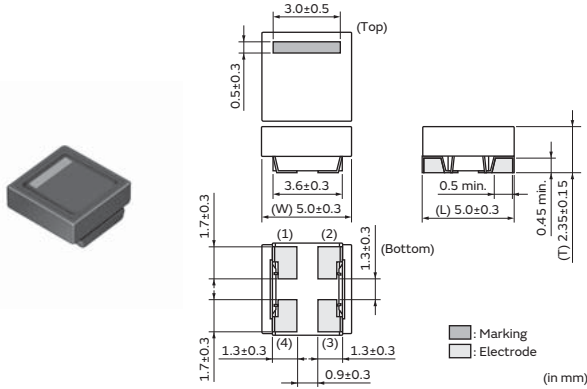

Packaging

Code	Packaging	Minimum Quantity
K	ø330mm Embossed Tape	2500
L	ø180mm Embossed Tape	700
B	Bulk(Bag)	100

Equivalent Circuit

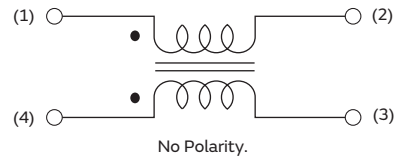

Rated Value (□: packaging code)

Part Number	Common Mode Impedance at 10MHz	Common Mode Impedance at 100MHz	Rated Current	Rated Voltage	Insulation Resistance (Min.)	Withstanding Voltage	DC Resistance
DLW5BTM101TQ2□	10Ωmin.	100Ω(Typ.)	6A	50Vdc	10MΩ	125Vdc	0.013Ω max.
DLW5BTM251TQ2□	20Ωmin.	250Ω(Typ.)	5A	50Vdc	10MΩ	125Vdc	0.020Ω max.
DLW5BTM501TQ2□	30Ωmin.	500Ω(Typ.)	4A	50Vdc	10MΩ	125Vdc	0.027Ω max.
DLW5BTM102TQ2□	60Ωmin.	1000Ω(Typ.)	2.5A	50Vdc	10MΩ	125Vdc	0.034Ω max.
DLW5BTM142TQ2□	100Ωmin.	1400Ω(Typ.)	2A	50Vdc	10MΩ	125Vdc	0.056Ω max.

Operating Temp. Range: -40°C to 105°C

Z-f Characteristics: DLW5BTM_TQ2 Series

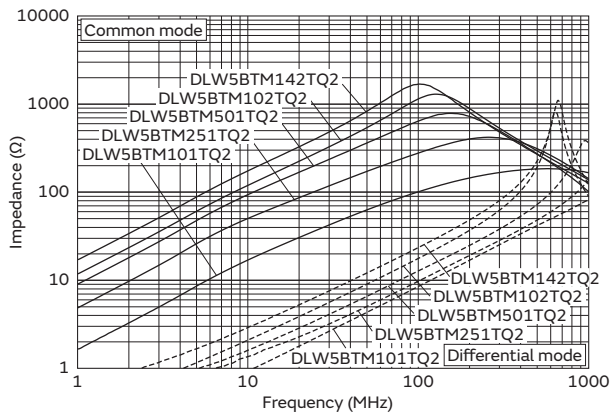

Derating of Rated Current

In operating temperature exceeding +85°C, derating of current is necessary for DLW5BT series (105 degree C available type). Please apply the derating curve shown in chart according to the operating temperature.

Derating of Rated Current

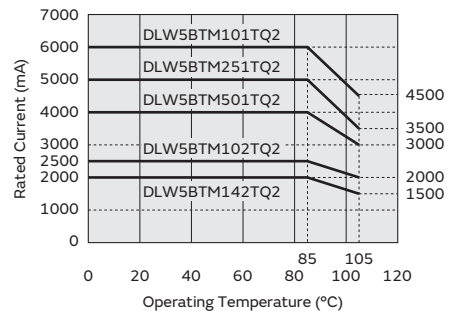

Common mode choke coil/Common mode noise filter

PLT5BPH Series 2020/5050(inch/mm)

Appearance/Dimensions

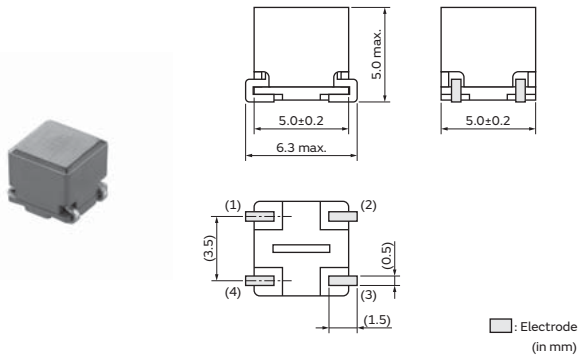

Packaging

Code	Packaging	Minimum Quantity
L	ø180mm Embossed Tape	300
B	Bulk(Bag)	50

Equivalent Circuit

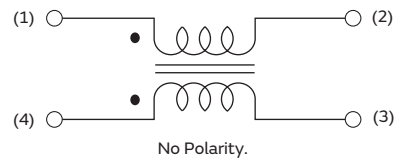

Rated Value (□: packaging code)

Part Number	Common Mode Impedance at 10MHz	Rated Current	Rated Voltage	Insulation Resistance (Min.)	Withstanding Voltage	DC Resistance
PLT5BPH1015R6SN□	100Ω(Typ.)	5.6A	80Vdc	10MΩ	200Vdc	4mΩ±30%
PLT5BPH2014R4SN□	200Ω(Typ.)	4.4A	80Vdc	10MΩ	200Vdc	7mΩ±30%
PLT5BPH3013R7SN□	300Ω(Typ.)	3.7A	80Vdc	10MΩ	200Vdc	11mΩ±30%
PLT5BPH5013R1SN□	500Ω(Typ.)	3.1A	80Vdc	10MΩ	200Vdc	17mΩ±30%

Operating Temp. Range: -55°C to 150°C

Z-f characteristics: PLT5BPH series

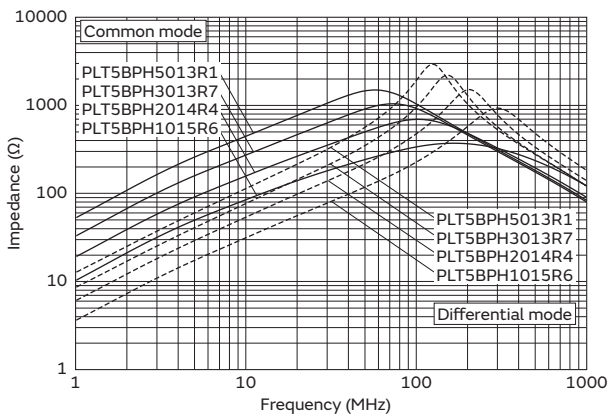

Derating of Rated Current

In operating temperature exceeding +125°C, derating of current is necessary for PLT5BP series. Please apply the derating curve shown in chart according to the operating temperature.

Derating of Rated Current

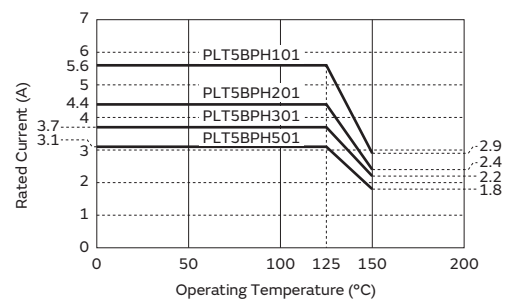

Common mode choke coil/Common mode noise filter

PLT10HH Series

Appearance/Dimensions

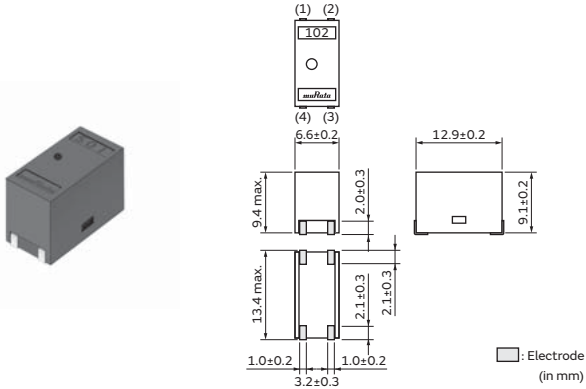

Packaging

Code	Packaging	Minimum Quantity
K	ø330mm Embossed Tape	500
L	ø180mm Embossed Tape	125
B	Bulk(Bag)	50

Equivalent Circuit

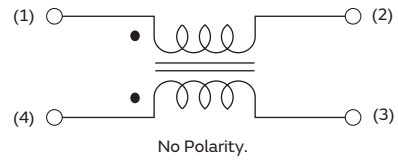

Rated Value (□: packaging code)

Part Number	Common Mode Impedance at 10MHz	Common Mode Inductance	Rated Current	Rated Voltage	Insulation Resistance (Min.)	Withstanding Voltage	DC Resistance	Operating Temp. Range
PLT10HH450180PN□	45Ω(Typ.)	0.8μHmin.	18A	300Vdc	10MΩ	750Vdc	1.3mΩ±0.5mΩ	-55°C to 125°C
PLT10HH101150PN□	100Ω(Typ.)	2.0μHmin.	15A	300Vdc	10MΩ	750Vdc	1.8mΩ±0.5mΩ	-55°C to 125°C
PLT10HH401100PN□	400Ω(Typ.)	6μHmin.	10A	100Vdc	10MΩ	250Vdc	3.6mΩ±0.5mΩ	-55°C to 125°C
PLT10HH501100PN□	500Ω(Typ.)	9μHmin.	10A	100Vdc	10MΩ	250Vdc	3.6mΩ±0.5mΩ	-55°C to 105°C
PLT10HH9016R0PN□	900Ω(Typ.)	14μHmin.	6A	100Vdc	10MΩ	250Vdc	8.0mΩ±0.5mΩ	-55°C to 125°C
PLT10HH1026R0PN□	1000Ω(Typ.)	20μHmin.	6A	100Vdc	10MΩ	250Vdc	8.0mΩ±0.5mΩ	-55°C to 105°C

Operating temperature should include self-temperature rise.

Z-f characteristics: PLT10HH series

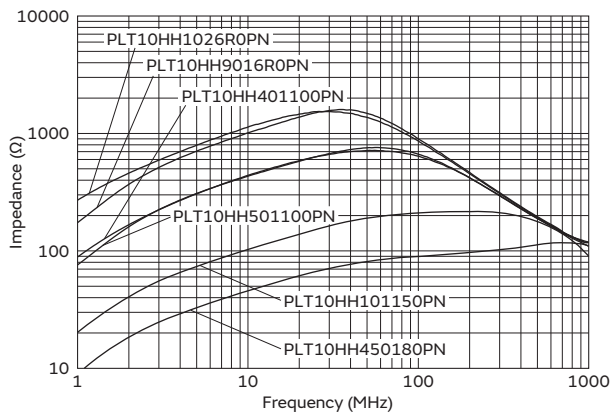

Derating of Rated Current

In operating temperature exceeding +65°C, derating of current is necessary for PLT10H series. Please apply the derating curve shown in chart according to the operating temperature.

Derating of Rated Current

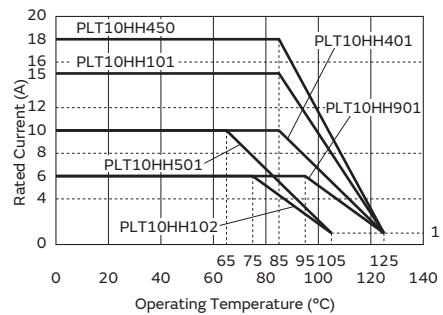

Common Mode Choke Coil/Common Mode Noise Filter (DLM/DLP/DLW/NFP) ⚠️Caution/Notice

⚠️Caution

Rating

Do not use products beyond the rated current and rated voltage as this may create excessive heat and deteriorate the insulation resistance. Be sure to provide an appropriate fail-safe function on your product to prevent secondary damage that may be caused by the abnormal function or the failure our product.

Soldering and Mounting

1. Self-heating

Please pay special attention when mounting chip common mode choke coils DLW5 series in close proximity to other products that radiate heat. The heat generated by other products may deteriorate the insulation resistance and cause excessive heat in this component.

2. Mounting Direction

Mount Chip Common Mode Choke Coils in the right direction. The wrong direction, which is 90 degrees rotated from the right direction, causes not only open or short circuit but also flames or other serious problems.

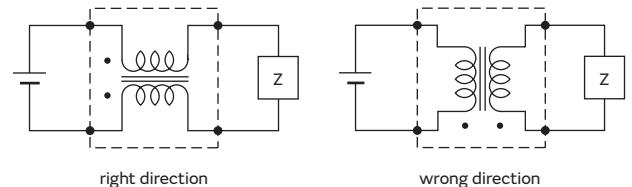

Notice

Storage and Operating Conditions

<Operating Environment>

Do not use products in a corrodible atmosphere such as acidic gases, alkaline gases, chlorine, sulfur gases, organic gases (a sea breeze, Cl₂, H₂S, NH₃, SO₂, NO₂, etc.).

Do not use products in an environment close to an organic solvent.

<Storage and Handling Requirements>

1. Storage Period

DLM11G series should be used within 6 months; the other series should be used within 12 months. Solderability should be checked if this period is exceeded.

2. Storage Conditions

- (1) Storage temperature: -10 to +40°C
Relative humidity: 15 to 85%
Avoid sudden changes in temperature and humidity.
- (2) Do not store products in a chemical atmosphere such as chlorine gas, acid or sulfide gas.

Notice (Soldering and Mounting)

1. Cleaning

Failure and degradation of a product can be caused by the cleaning method. When you clean in conditions that are not in the mounting information, please contact Murata engineering.

2. Soldering

Reliability decreases with improper soldering methods. Please solder by the standard soldering conditions shown in the mounting information.

3. Other

Noise suppression levels resulting from Murata's EMI suppression filters EMIFIL® may vary, depending on the circuits and ICs used, type of noise, mounting pattern, mounting location, and other operating conditions. Be sure to check and confirm in advance the noise suppression effect of each filter, in actual circuits, etc. before applying the filter in a commercial-purpose equipment design.

Continued on the following page. ↗

Common Mode Choke Coil/Common Mode Noise Filter (DLM/DLP/DLW/NFP) ⚠Caution/Notice

Continued from the preceding page. ↘

Handling

1. Resin Coating (except for DLW Series)

Using resin for coating/molding products may affect the product's performance.

So please pay careful attention in selecting resin.

Prior to use, please make a reliability evaluation with the product mounted in your application set.

2. Resin Coating (DLW Series)

The impedance value may change due to high cure-stress of resin to be used for coating/molding products. An open circuit issue may occur by mechanical stress caused by the resin, amount/cured shape of resin, or operating conditions, etc. Some resins containing impurities or chloride may possibly generate chlorine by hydrolysis under some operating conditions, causing corrosion of the coil wire and leading to an open circuit.

Therefore, please pay careful attention to selecting the resin for coating/molding the products. Prior to using the coating resin, please ensure that no reliability issue is observed by evaluating products mounted on your board.

3. Caution for Use (DLW Series)

When you hold products with a tweezer, please hold by the sides. Sharp materials, such as a pair of tweezers, should not touch the winding portion to prevent breaking the wire. To prevent breaking the core, mechanical shock should not be applied to the products mounted on the board.

4. Brushing

When you clean the neighborhood of products such as connector pins, cleaning brush bristles should not be touched to the winding portion of this product to prevent breaking the wire.

5. Handling of Substrates

After mounting products on a substrate, do not apply any stress to the product by bending or twisting the substrate when cropping the substrate, inserting and removing a connector from the substrate or tightening a screw to the substrate. Excessive mechanical stress may cause cracking in the product.

Bending

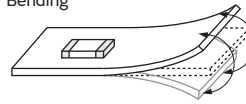

Twisting

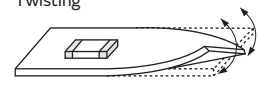

Common Mode Choke Coil (PLT) ⚠Caution/Notice

⚠Caution

Rating

1. Do not use products beyond the rated current and rated voltage as this may create excessive heat and deteriorate the insulation resistance.
2. Be sure to provide an appropriate fail-safe function on your product to prevent secondary damage that may be caused by the abnormal function or the failure our product.

Soldering and Mounting

1. Self-heating

Please pay special attention when mounting chip common mode choke coils in close proximity to other products that radiate heat. The heat generated by other products may deteriorate the insulation resistance and cause excessive heat in this component.

2. Mounting Direction

Mount Chip Common Mode Choke Coils in the right

direction. The wrong direction, which is 90 degrees rotated from the right direction, causes not only open or short circuit but also flames or other serious problems.

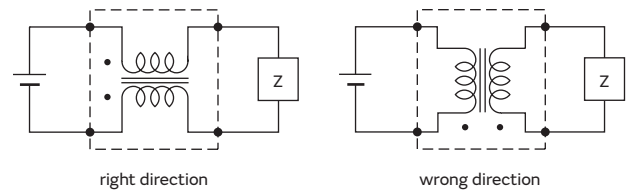

Notice

Storage and Operating Conditions

<Operating Environment>

Do not use products in a chemical atmosphere such as chlorine gas, acid or sulfide gas.
 Do not use products in an environment close to an organic solvent.

<Storage and Handling Requirements>

1. Storage Period

PLT10H series should be used within 12 months.

Solderability should be checked if this period is exceeded.

2. Storage Conditions

- (1) Storage temperature: -10 to +40°C
 Relative humidity: 15 to 85%
 Avoid sudden changes in temperature and humidity.
- (2) Do not store products in a chemical atmosphere such as chlorine gas, acid or sulfide gas.

Notice (Soldering and Mounting)

1. Cleaning

Failure and degradation of a product can be caused by the cleaning method. When you clean in conditions that are not in the mounting information, please contact Murata engineering.

2. Soldering

Reliability decreases with improper soldering methods. Please solder by the standard soldering conditions shown in the mounting information.

3. Other

Noise suppression levels resulting from Murata's EMI suppression filters EMIFIL® may vary, depending on the circuits and ICs used, type of noise, mounting pattern, mounting location, and other operating conditions. Be sure to check and confirm in advance the noise suppression effect of each filter, in actual circuits, etc. before applying the filter in a commercial-purpose equipment design.

Handling

1. Handling of Substrates

After mounting products on a substrate, do not apply any stress to the product by bending or twisting the substrate when cropping the substrate, inserting and removing a connector from the substrate or tightening a screw to the substrate.

Excessive mechanical stress may cause cracking in the product.



Common Mode Choke Coil/Common Mode Noise Filter (DLM/DLP/DLW/NFP) Soldering and Mounting

1. Standard Land Pattern Dimensions

Land Pattern + Solder Resist
 Land Pattern
 Solder Resist
 (in mm)

Series	Standard Land Dimensions																	
DLM0QS DLM0NS DLM11G DLM11S DLP0QS DLP0NS DLP11R DLP11S DLP11T DLP31S DLP1ND DLP2AD DLP31D DLW21H DLW21S DLW31SN NFP0QH NFP0QS DLW44 DLW5A DLW5B	●Reflow and Flow DLP31S																	
			DLP31D															
	●Reflow Soldering																	
	DLM0QS/DLP0QS/NFP0QH/0QS		DLM0NS/DLP0NS															
	DLP11S/DLM11S		DLP11R/11T															
	DLP1ND		DLP2AD															
DLW11G		DLW21S/21H/31SN																
DLW44		DLW5A/5B (except for DLW5AT_MQ2)																
		<table border="1" style="margin: auto; border-collapse: collapse;"> <thead> <tr> <th style="width: 20%;">Series</th> <th style="width: 10%;">a</th> <th style="width: 10%;">b</th> <th style="width: 10%;">c</th> <th style="width: 10%;">d</th> </tr> </thead> <tbody> <tr> <td>DLW21S/H</td> <td>0.8</td> <td>2.6</td> <td>0.4</td> <td>1.2</td> </tr> <tr> <td>DLW31SN</td> <td>1.6</td> <td>3.7</td> <td>0.4</td> <td>1.6</td> </tr> </tbody> </table>		Series	a	b	c	d	DLW21S/H	0.8	2.6	0.4	1.2	DLW31SN	1.6	3.7	0.4	1.6
Series	a	b	c	d														
DLW21S/H	0.8	2.6	0.4	1.2														
DLW31SN	1.6	3.7	0.4	1.6														
		*1: If the pattern is made wider than 1.2mm (DLW21) / 1.6mm (DLW31S) it may result in components turning around, because melting speed is different. In the worst case, short circuit between lines may occur. *2: If the pattern is made with less than specified dimensions, in the worst case, short circuit between lines may occur due to spread of soldering paste or mount placing accuracy. *3: If the pattern is made wider than 0.8mm (DLW21) / 1.6mm (DLW31SN), the bending strength will be reduced. Do not use gild pattern; excess soldering heat may dissolve the metal of a copper wire.																

Continued on the following page. ➔

Common Mode Choke Coil/Common Mode Noise Filter (DLM/DLP/DLW/NFP) Soldering and Mounting

Continued from the preceding page. ↘

Series	Standard Land Dimensions	
	●Reflow Soldering Chip Mounting Side	●Flow Soldering Chip Mounting Side
DLW5AT_MQ2	<p>DLW5AT_MQ2</p>	<p>DLW5AT_MQ2</p>

● PCB Warping

PCB should be designed so that products are not subjected to mechanical stress caused by warping the board.

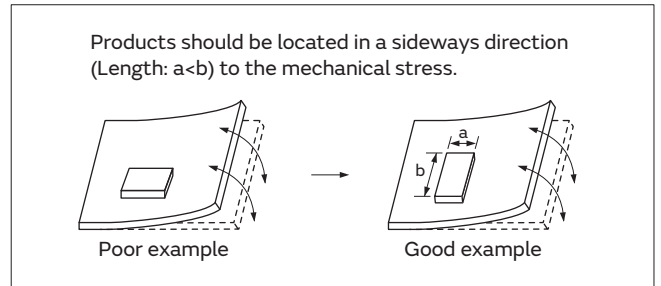

2. Solder Paste Printing and Adhesive Application

When reflow soldering the chip common mode choke coils, the printing must be conducted in accordance with the following cream solder printing conditions.

If too much solder is applied, the chip will be prone to damage by mechanical and thermal stress from the PCB and may crack.

Standard land dimensions should be used for resist and copper foil patterns.

When flow soldering the chip common mode choke coils, apply the adhesive in accordance with the following conditions.

If too much adhesive is applied, it may overflow into the land or termination areas and yield poor solderability.

In contrast, if insufficient adhesive is applied, or if the adhesive is not sufficiently hardened, then the chip may become detached during the flow soldering process.

Continued on the following page. ↗

Common Mode Choke Coil/Common Mode Noise Filter (DLM/DLP/DLW/NFP) Soldering and Mounting

Continued from the preceding page. ↘

(in mm)

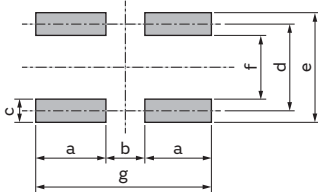
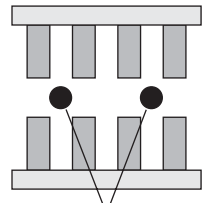
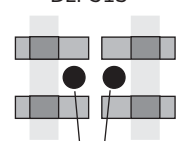
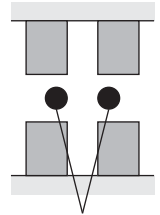
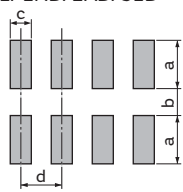
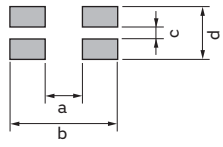
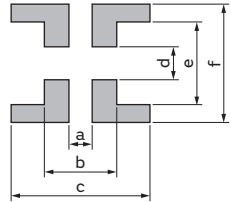
Series	Solder Paste Printing	Adhesive Application																																																								
DLM DLP DLW NFP	<p>●Guideline of solder paste thickness: 80-100µm: DLP0QS 100-150µm: DLM0QS/ONS/DLM11G/11S, DLPONS/11R/11S/11T/1ND/2AD, DLW21H/21S/31S, NFP0QH/0QS 150-200µm: DLP31D/31S, DLW5A/5B</p> <p>*Solderability is subject to reflow conditions and thermal conductivity. Please ensure that your product has been evaluated in view of your specifications with our product being mounted to your product.</p> <p>DLM0QS/ONS/11G/11S/DLP0QS/ONS/11R/11S/11T/31S/NFP0QH/0QS</p>  <table border="1"> <thead> <tr> <th>Series</th> <th>a</th> <th>b</th> <th>c</th> <th>d</th> <th>e</th> <th>f</th> <th>g</th> </tr> </thead> <tbody> <tr> <td>DLM0QS/DLP0QS/NFP0QH/0QS</td> <td>0.3</td> <td>0.2</td> <td>0.23</td> <td>-</td> <td>0.71</td> <td>-</td> <td>-</td> </tr> <tr> <td>DLMONS/DLPONS</td> <td>0.3</td> <td>0.3</td> <td>0.3</td> <td>0.5</td> <td>-</td> <td>-</td> <td>-</td> </tr> <tr> <td>DLM11G</td> <td>-</td> <td>0.5</td> <td>-</td> <td>-</td> <td>1.1</td> <td>0.3</td> <td>1.5</td> </tr> <tr> <td>DLM11S/DLP11S</td> <td>0.7</td> <td>0.55</td> <td>0.3</td> <td>0.55</td> <td>-</td> <td>-</td> <td>-</td> </tr> <tr> <td>DLP11R/T</td> <td>0.5</td> <td>0.55</td> <td>0.3</td> <td>0.55</td> <td>-</td> <td>-</td> <td>-</td> </tr> <tr> <td>DLP31S</td> <td>1.0</td> <td>0.6</td> <td>0.7</td> <td>2.1</td> <td>-</td> <td>-</td> <td>-</td> </tr> </tbody> </table>	Series	a	b	c	d	e	f	g	DLM0QS/DLP0QS/NFP0QH/0QS	0.3	0.2	0.23	-	0.71	-	-	DLMONS/DLPONS	0.3	0.3	0.3	0.5	-	-	-	DLM11G	-	0.5	-	-	1.1	0.3	1.5	DLM11S/DLP11S	0.7	0.55	0.3	0.55	-	-	-	DLP11R/T	0.5	0.55	0.3	0.55	-	-	-	DLP31S	1.0	0.6	0.7	2.1	-	-	-	<p>DLP31S/DLP31D/ DLW5AT_MQ2 Apply 0.3mg of bonding agent at each chip.</p> <p>DLP31D</p>  <p>Coating Position of Bonding Agent</p> <p>DLP31S</p>  <p>Coating Position of Bonding Agent</p> <p>DLW5AT_MQ2</p>  <p>Coating Position of Bonding Agent</p>
	Series	a	b	c	d	e	f	g																																																		
	DLM0QS/DLP0QS/NFP0QH/0QS	0.3	0.2	0.23	-	0.71	-	-																																																		
	DLMONS/DLPONS	0.3	0.3	0.3	0.5	-	-	-																																																		
	DLM11G	-	0.5	-	-	1.1	0.3	1.5																																																		
	DLM11S/DLP11S	0.7	0.55	0.3	0.55	-	-	-																																																		
	DLP11R/T	0.5	0.55	0.3	0.55	-	-	-																																																		
	DLP31S	1.0	0.6	0.7	2.1	-	-	-																																																		
		<p>DLP1ND/2AD/31D</p>  <table border="1"> <thead> <tr> <th>Series</th> <th>a</th> <th>b</th> <th>c</th> <th>d</th> </tr> </thead> <tbody> <tr> <td>DLP1ND</td> <td>0.3</td> <td>0.3</td> <td>0.2</td> <td>0.4</td> </tr> <tr> <td>DLP2AD</td> <td>0.55</td> <td>0.4</td> <td>0.25</td> <td>0.5</td> </tr> <tr> <td>DLP31D</td> <td>1.0</td> <td>0.8</td> <td>0.4</td> <td>0.8</td> </tr> </tbody> </table>	Series	a	b	c	d	DLP1ND	0.3	0.3	0.2	0.4	DLP2AD	0.55	0.4	0.25	0.5	DLP31D	1.0	0.8	0.4	0.8																																				
	Series	a	b	c	d																																																					
DLP1ND	0.3	0.3	0.2	0.4																																																						
DLP2AD	0.55	0.4	0.25	0.5																																																						
DLP31D	1.0	0.8	0.4	0.8																																																						
	<p>DLW21S/21H/31S</p>  <table border="1"> <thead> <tr> <th>Series</th> <th>a</th> <th>b</th> <th>c</th> <th>d</th> </tr> </thead> <tbody> <tr> <td>DLW21S/H</td> <td>0.8</td> <td>2.6</td> <td>0.5</td> <td>1.2</td> </tr> <tr> <td>DLW31S</td> <td>1.6</td> <td>3.7</td> <td>0.4</td> <td>1.6</td> </tr> </tbody> </table>	Series	a	b	c	d	DLW21S/H	0.8	2.6	0.5	1.2	DLW31S	1.6	3.7	0.4	1.6																																										
Series	a	b	c	d																																																						
DLW21S/H	0.8	2.6	0.5	1.2																																																						
DLW31S	1.6	3.7	0.4	1.6																																																						
	<p>DLW44/5A/5B</p>  <table border="1"> <thead> <tr> <th>Series</th> <th>a</th> <th>b</th> <th>c</th> <th>d</th> <th>e</th> <th>f</th> </tr> </thead> <tbody> <tr> <td>DLW44</td> <td>0.8</td> <td>2.5</td> <td>5.6</td> <td>0.9</td> <td>1.9</td> <td>3.9</td> </tr> <tr> <td>DLW5A/5B</td> <td>0.9</td> <td>2.9</td> <td>5.5</td> <td>1.3</td> <td>3.3</td> <td>4.7</td> </tr> </tbody> </table>	Series	a	b	c	d	e	f	DLW44	0.8	2.5	5.6	0.9	1.9	3.9	DLW5A/5B	0.9	2.9	5.5	1.3	3.3	4.7																																				
Series	a	b	c	d	e	f																																																				
DLW44	0.8	2.5	5.6	0.9	1.9	3.9																																																				
DLW5A/5B	0.9	2.9	5.5	1.3	3.3	4.7																																																				

Continued on the following page. ↗

Common Mode Choke Coil/Common Mode Noise Filter (DLM/DLP/DLW/NFP) Soldering and Mounting

Continued from the preceding page. ↘

3. Standard Soldering Conditions

(1) Soldering Methods

Use flow and reflow soldering methods only.
 Use standard soldering conditions when soldering chip common mode choke coils.
 In cases where several different parts are soldered, each having different soldering conditions, use those conditions requiring the least heat and minimum time.

Solder: Use Sn-3.0Ag-0.5Cu solder. Use of Sn-Zn based solder will deteriorate performance of products.
 If using DLP/DLM series with Sn-Zn based solder, please contact Murata in advance.

Flux:

- Use rosin-based flux.
 In case of DLW21/31 series, use rosin-based flux with converting chlorine content of 0.06 to 0.1wt%.
 In case of using RA type solder, products should be cleaned completely with no residual flux.
- Do not use strong acidic flux (with chlorine content exceeding 0.20wt%)
- Do not use water-soluble flux.

For additional mounting methods, please contact Murata.

(2) Soldering Profile

● Flow Soldering Profile (Sn-3.0Ag-0.5Cu Solder)

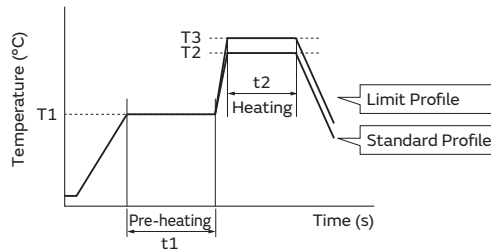

Series	Pre-heating		Standard Profile			Limit Profile		
	Temp. (T1)	Time (t1)	Heating		Cycle of Flow	Heating		Cycle of Flow
			Temp. (T2)	Time (t2)		Temp. (T3)	Time (t2)	
DLW5AT_MQ2 DLP31D/31S	150°C	60s min.	250°C	4 to 6s	2 times max.	265±3°C	5s max.	2 times max.

● Reflow Soldering Profile (Sn-3.0Ag-0.5Cu Solder)

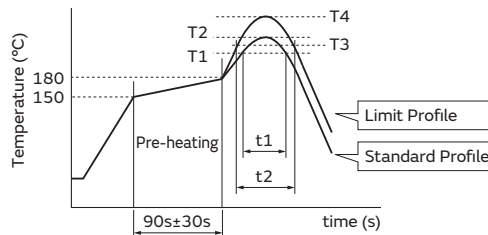

Series	Standard Profile				Limit Profile			
	Heating		Peak Temperature (T2)	Cycle of Reflow	Heating		Peak Temperature (T4)	Cycle of Reflow
	Temp. (T1)	Time (t1)			Temp. (T3)	Time (t2)		
DLM/DLP DLW21/31 NFP	220°C min.	30 to 60s	245±3°C	2 times max.	230°C min.	60s max.	260°C/10s	2 times max.
DLW44/5A/5B	220°C min.	30 to 60s	250±3°C	2 times max.	230°C min.	60s max.	260°C/10s	2 times max.

Continued on the following page. ↗

Common Mode Choke Coil/Common Mode Noise Filter (DLM/DLP/DLW/NFP) Soldering and Mounting

Continued from the preceding page. ↘

(3) Reworking with a soldering Iron

The following conditions must be strictly followed when using a soldering iron.

Pre-heating: 150°C 60s min.

Soldering iron power output / Tip diameter:

30W max. / ø3mm max.

Temperature of soldering iron tip / Soldering time /

Times:

350°C max. / 3-4s / 2 times*¹

*¹ DLM0Q/0N,DLP0QS/0NS,DLP11S/11T/1ND

DLP2AD: 380°C max. / 3-4s / 2 times

NFP0QH/0QS cannot be reworked with a soldering iron.

Do not allow the tip of the soldering iron to directly contact the chip.

For additional methods of reworking with a soldering iron, please contact Murata engineering.

4. Cleaning

The following conditions should be observed when cleaning chip EMI filters.

(1) Cleaning temperature: 60°C max. (40°C max. for alcohol type cleaner)

(2) Ultrasonic

Output: 20W/liter max.

Duration: 5 minutes max.

Frequency: 28 to 40kHz

(3) Cleaning agent

The following cleaning agents have been tested on the individual components. Evaluation of final assembly should be completed prior to production.

Do not clean DLW (except for DLW21H) series.

Before cleaning, please contact Murata engineering.

(a) Alcohol cleaning agent

Isopropyl alcohol (IPA)

(b) Aqueous cleaning agent

Pine Alpha ST-100S

(4) Ensure that flux residue is completely removed.

The component should be thoroughly dried after the aqueous agent has been removed with deionized water.

Common Mode Choke Coil (PLT) Soldering and Mounting

1. Standard Land Pattern Dimensions

(in mm)

Series	Standard Land Dimensions	
PLT5BP PLT10H	●Reflow Soldering	
	<p>PLT5BP</p>	<p>PLT10H</p>

● PCB Warping

PCB should be designed so that products are not subjected to mechanical stress caused by warping the board.

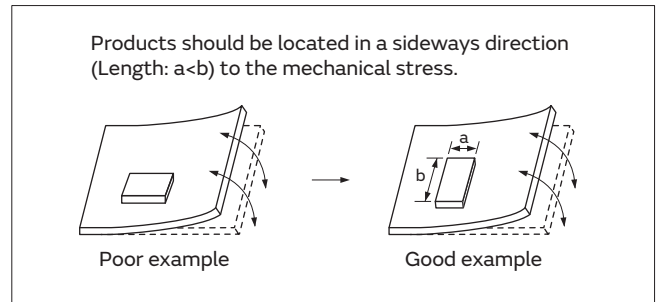

2. Solder Paste Printing and Adhesive Application

When reflow soldering the chip common mode choke coils, the printing must be conducted in accordance with the following cream solder printing conditions.

If too much solder is applied, the chip will be prone to damage by mechanical and thermal stress from the PCB and may crack.

Standard land dimensions should be used for resist and copper foil patterns.

When flow soldering the chip common mode choke coils, apply the adhesive in accordance with the following conditions.

If too much adhesive is applied, it may overflow into the land or termination areas and yield poor solderability. In contrast, if insufficient adhesive is applied, or if the adhesive is not sufficiently hardened, then the chip may become detached during the flow soldering process.

Series	Solder Paste Printing
PLT5BP PLT10H	●Guideline of solder paste thickness: 150μm: PLT5BP 150-200μm: PLT10H For the solder paste printing pattern, use standard land dimensions.
	*Solderability is subject to reflow conditions and thermal conductivity. Please ensure that your product has been evaluated in view of your specifications with our product being mounted to your product.

Continued on the following page. ↗

Common Mode Choke Coil (PLT) Soldering and Mounting

Continued from the preceding page. ↘

3. Standard Soldering Conditions

(1) Soldering Methods

Use reflow soldering methods only.
 Use standard soldering conditions when soldering chip common mode choke coils.
 In cases where several different parts are soldered, each having different soldering conditions, use those conditions requiring the least heat and minimum time.

Solder: Use Sn-3.0Ag-0.5Cu solder. Use of Sn-Zn based solder will deteriorate performance of products.

Flux:

- Use rosin-based flux.
- Do not use strong acidic flux (with chlorine content exceeding 0.20wt%)
- Do not use water-soluble flux.

For additional mounting methods, please contact Murata.

(2) Soldering Profile

- Reflow Soldering Profile (Sn-3.0Ag-0.5Cu Solder)

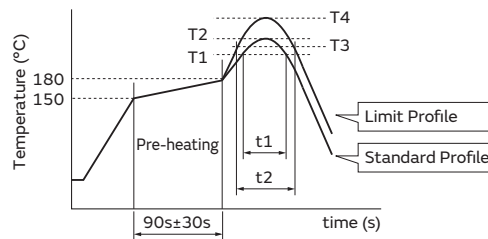

Series	Standard Profile				Limit Profile			
	Heating		Peak Temperature (T2)	Cycle of Reflow	Heating		Peak Temperature (T4)	Cycle of Reflow
	Temp. (T1)	Time (t1)			Temp. (T3)	Time (t2)		
PLT5BP	220°C min.	30 to 60s	245±3°C	2 times	240°C min.	30s max.	260°C/10s	2 times
PLT10H	220°C min.	30 to 60s	250±3°C	2 times max.	230°C min.	60s max.	260°C/10s	2 times max.

(3) Reworking with a soldering Iron

The following conditions must be strictly followed when using a soldering iron.

Pre-heating: 150°C 60s min.

Soldering iron power output / Tip diameter:

30W max. / ø3mm max.: PLT5BP

80W max. / ø3mm max.: PLT10H

Temperature of soldering iron tip / Soldering time / Times:

350°C max. / 3 to 4s / 2 times: PLT5BP

400°C max. / 5s / 2 times: PLT10H

Do not allow the tip of the soldering iron to directly contact the chip.

For additional methods of reworking with a soldering iron, please contact Murata engineering.

4. Cleaning

Do not clean after soldering. If cleaning, please contact us.

Common Mode Choke Coil/Common Mode Noise Filter (DLM/DLP/DLW/NFP) Packaging

Minimum Quantity and Dimensions of 8mm Width Paper / Embossed Tape

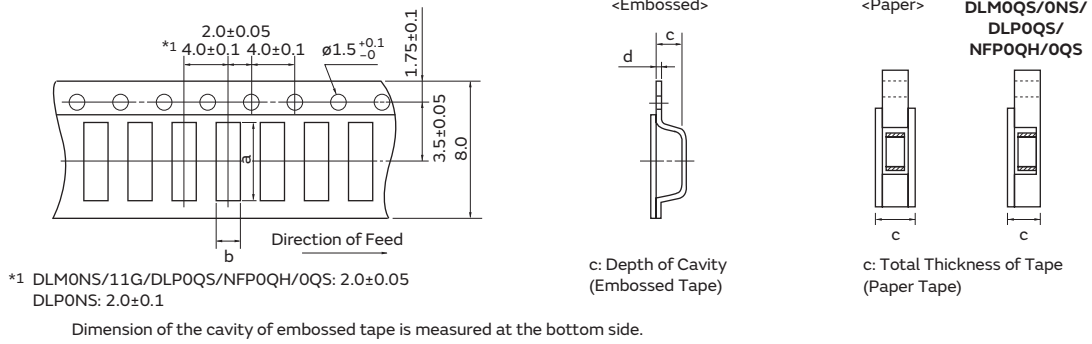

Part Number	Dimensions				Minimum Qty. (pcs.)				
					ø180mm Reel		ø330mm Reel		Bulk
	a	b	c	d	Paper Tape	Embossed Tape	Paper Tape	Embossed Tape	
DLM0QS/DLP0QS	0.73	0.6	0.55 max.	-	15000	-	-	-	500
DLMONS	0.97	0.77	0.8 max.	-	10000	-	-	-	500
DLM11G	1.45	1.2	0.8 max.	-	10000	-	-	-	1000
DLM11S	1.4	1.15	0.65	0.25	-	4000	-	-	500
DLPONS	0.95	0.75	0.55	0.25	-	10000	-	-	500
DLP11R	1.4	1.15	0.7	0.25	-	4000	-	-	500
DLP11S	1.4	1.2	0.98	0.25	-	3000	-	-	500
DLP11T	1.35	1.1	0.45	0.25	-	5000	-	-	500
DLP31S/31D	3.5	1.9	1.3	0.25	-	3000	-	-	500
DLP1ND	1.7	0.84	0.57	0.25	-	5000	-	-	500
DLP2AD	2.2	1.2	0.98	0.25	-	3000	-	-	500
DLW21H	2.3	1.55	1.1	0.25	-	3000	-	-	500
DLW21SN	2.25	1.45	1.4	0.25	-	2000	-	-	500
DLW31S	3.6	2.0	2.1	0.3	-	2000	-	-	500
NFP0QH/OQS	0.73	0.6	0.43 max.	-	15000	-	-	-	500

(in mm)

Minimum Quantity and Dimensions of 12mm Width Embossed Tape

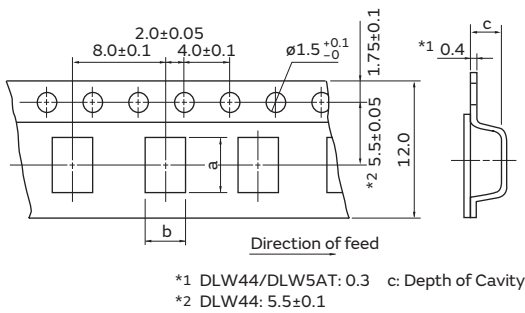

Part Number	Dimensions			Minimum Qty. (pcs.)		
	a	b	c	ø180mm Reel	ø330mm Reel	Bulk
DLW44S	4.3	4.3	1.7	1000	3500	100
DLW5AH	5.4	4.1	4.4	400	1500	100
DLW5AT	5.4	4.1	2.7	700	2500	100
DLW5BS	5.5	5.4	4.7	400	1500	100
DLW5BT	5.5	5.5	2.7	700	2500	100

(in mm)

"Minimum Quantity" means the number of units of each delivery or order. The quantity should be an integral multiple of the "Minimum Quantity."

Common Mode Choke Coil (PLT) Packaging

Minimum Quantity and Dimensions of 12mm Width Embossed Tape

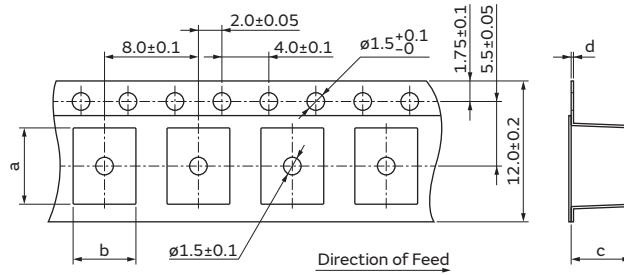

Dimension of the cavity is measured at the bottom side.

Part Number	Dimensions				Minimum Qty. (pcs.)		
	a	b	c	d	ø180mm Reel	ø330mm Reel	Bulk
PLT5BP	6.5	5.35	5.1	0.4	300	-	50

(in mm)

Minimum Quantity and Dimensions of 24mm Width Embossed Tape

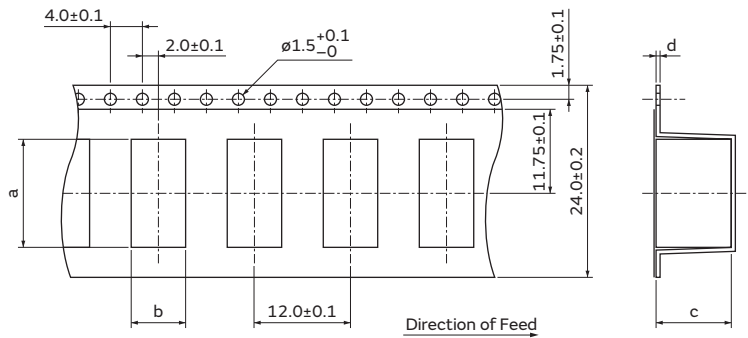

Dimension of the cavity is measured at the bottom side.

Part Number	Dimensions				Minimum Qty. (pcs.)		
	a	b	c	d	ø180mm Reel	ø330mm Reel	Bulk
PLT10H	13.5	6.8	9.4	0.5	125	500	50

(in mm)

Block Type EMIFIL® BNX Series

Series Lineup/Function Example	p254
Product Detail	p256
⚠Caution/Notice	p260
Soldering and Mounting	p262
Packaging	p266

Block Type EMIFIL[®] (BNX) Series Lineup / Function Example

Type	Part Number	Thickness (mm)	Rated Voltage	Effective Frequency Range	Rated Current	Comments
SMD Type for Power Lines	p256 BNX022-01□	3.1	50Vdc	1MHz to 1GHz:35dB min.	20A	
	BNX023-01□	3.1	100Vdc	1MHz to 1GHz:35dB min.	20A	
	BNX028-01□	3.5	16Vdc	30kHz to 1GHz:35dB min.	20A	
	BNX029-01□	3.5	6.3Vdc	15kHz to 1GHz:35dB min.	20A	
	BNX024H01□	3.5	50Vdc	100kHz to 1GHz:35dB min.	20A	Automotive Available
	BNX025H01□	3.5	25Vdc	50kHz to 1GHz:35dB min.	20A	Automotive Available
	BNX026H01□	3.5	50Vdc	50kHz to 1GHz:35dB min.	20A	Automotive Available
	BNX027H01□	3.5	16Vdc	40kHz to 1GHz:35dB min.	20A	Automotive Available
Lead Type Low Profile for Power Lines	p258 BNX012-01	8.0	50Vdc	1MHz to 1GHz:40dB min.	15A	
	BNX016-01	8.0	25Vdc	100kHz to 1GHz:40dB min.	15A	

Suppression of Radiation Noise from Power Line Cable

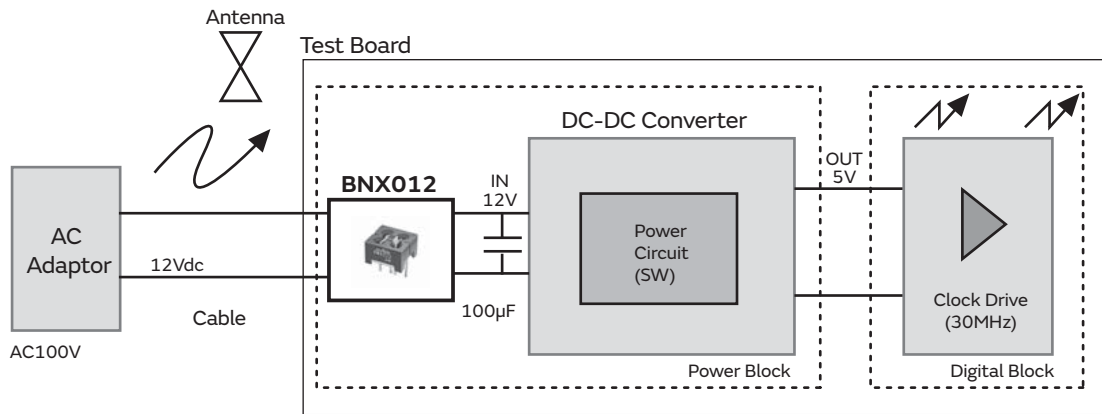

Test Result

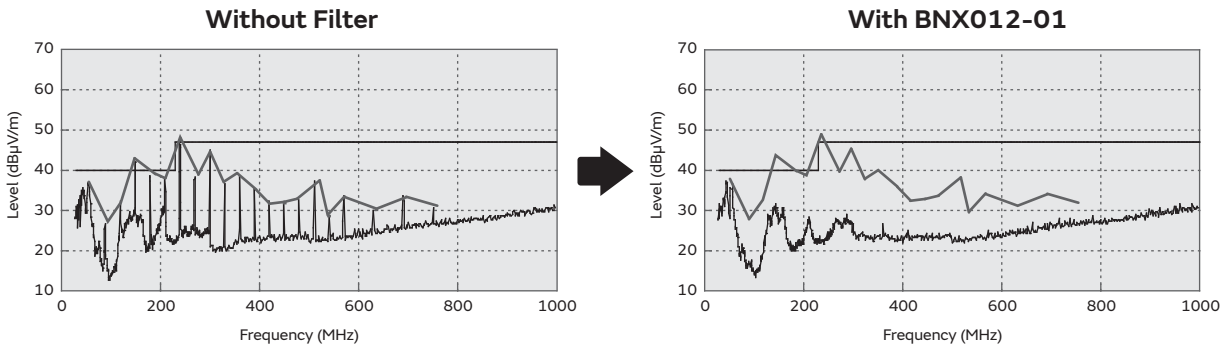

Block Type EMIFIL[®] (BNX) Series Lineup / Function Example

Impulse Noise Countermeasure

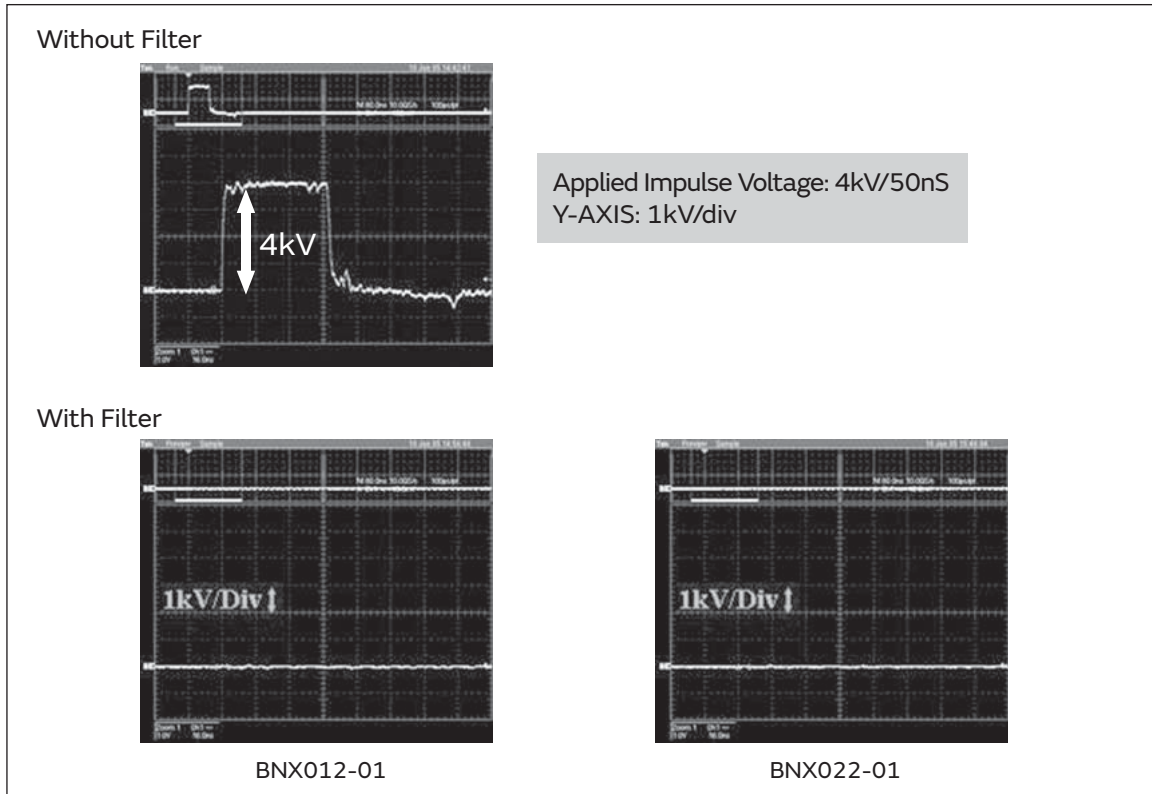
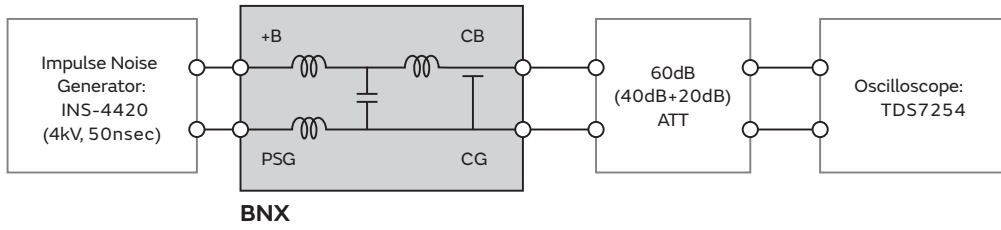

ESD Countermeasure

ESD Waveform Comparison

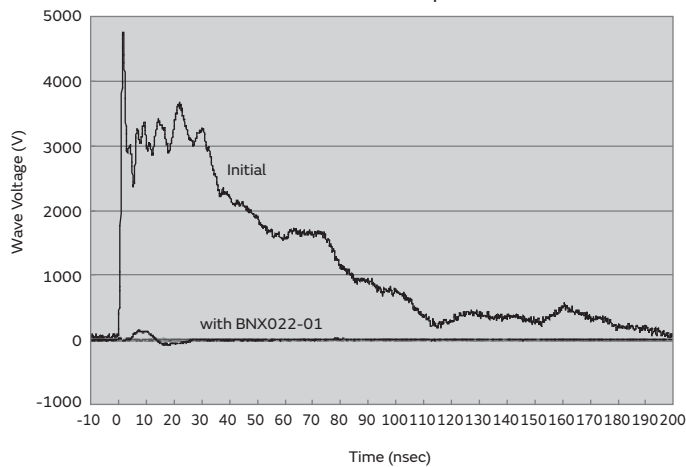

Block Type EMIFIL®

BNX02□ Series

Appearance/Dimensions

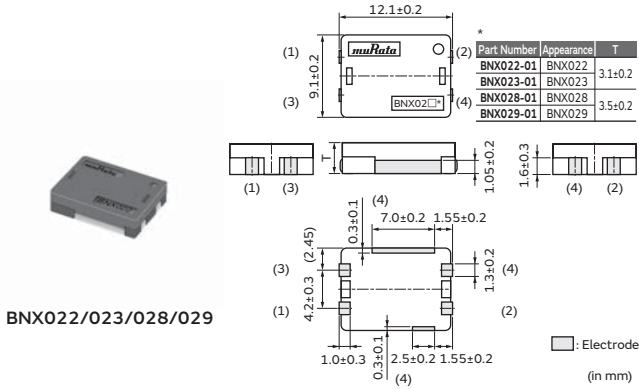

BNX022/023/028/029

Appearance/Dimensions

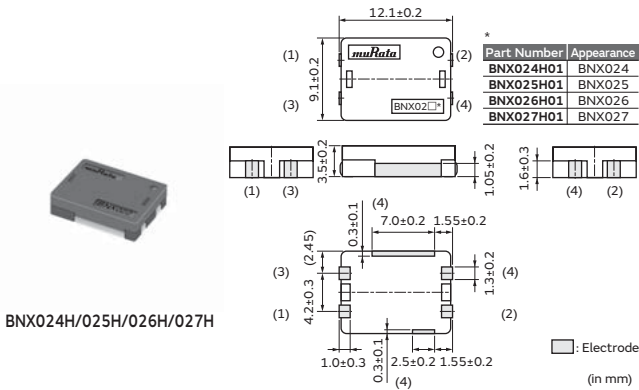

BNX024H/025H/026H/027H

Rated Value (□: packaging code)

Part Number	Rated Voltage	Withstand Voltage	Rated Current	Insulation Resistance (min.)	Insertion Loss (Line impedance=50 ohm)
BNX022-01□	50Vdc	125Vdc	20A	500MΩ	1MHz to 1GHz:35dB min.
BNX023-01□	100Vdc	250Vdc	20A	500MΩ	1MHz to 1GHz:35dB min.
BNX028-01□	16Vdc	40Vdc	20A	1.1MΩ	30kHz to 1GHz:35dB min.
BNX029-01□	6.3Vdc	15.8Vdc	20A	0.5MΩ	15kHz to 1GHz:35dB min.
BNX024H01□	50Vdc	125Vdc	20A	100MΩ	100kHz to 1GHz:35dB min.
BNX025H01□	25Vdc	62.5Vdc	20A	50MΩ	50kHz to 1GHz:35dB min.
BNX026H01□	50Vdc	125Vdc	20A	10MΩ	50kHz to 1GHz:35dB min.
BNX027H01□	16Vdc	40Vdc	20A	1MΩ	40kHz to 1GHz:35dB min.

Operating Temperature Range: -40°C to 125°C (BNX022/023/029), -40°C to 105°C (BNX028), -55°C to 125°C (BNX024H/025H/026H/027H)

Packaging

Code	Packaging	Minimum Quantity
L	ø180mm Embossed Tape	400
K	ø330mm Embossed Tape	1500
B	Bulk(Bag)	100

Equivalent Circuit

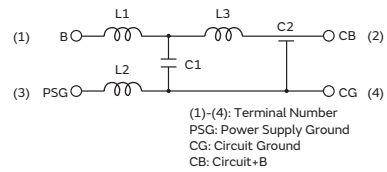

Packaging

Code	Packaging	Minimum Quantity
L	ø180mm Embossed Tape	400
K	ø330mm Embossed Tape	1500
B	Bulk(Bag)	100

Equivalent Circuit

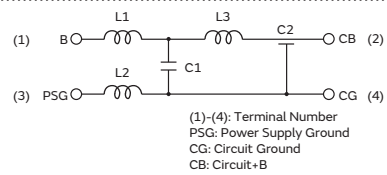

Continued on the following page. ↗

Continued from the preceding page. ↘

Insertion Loss Characteristics

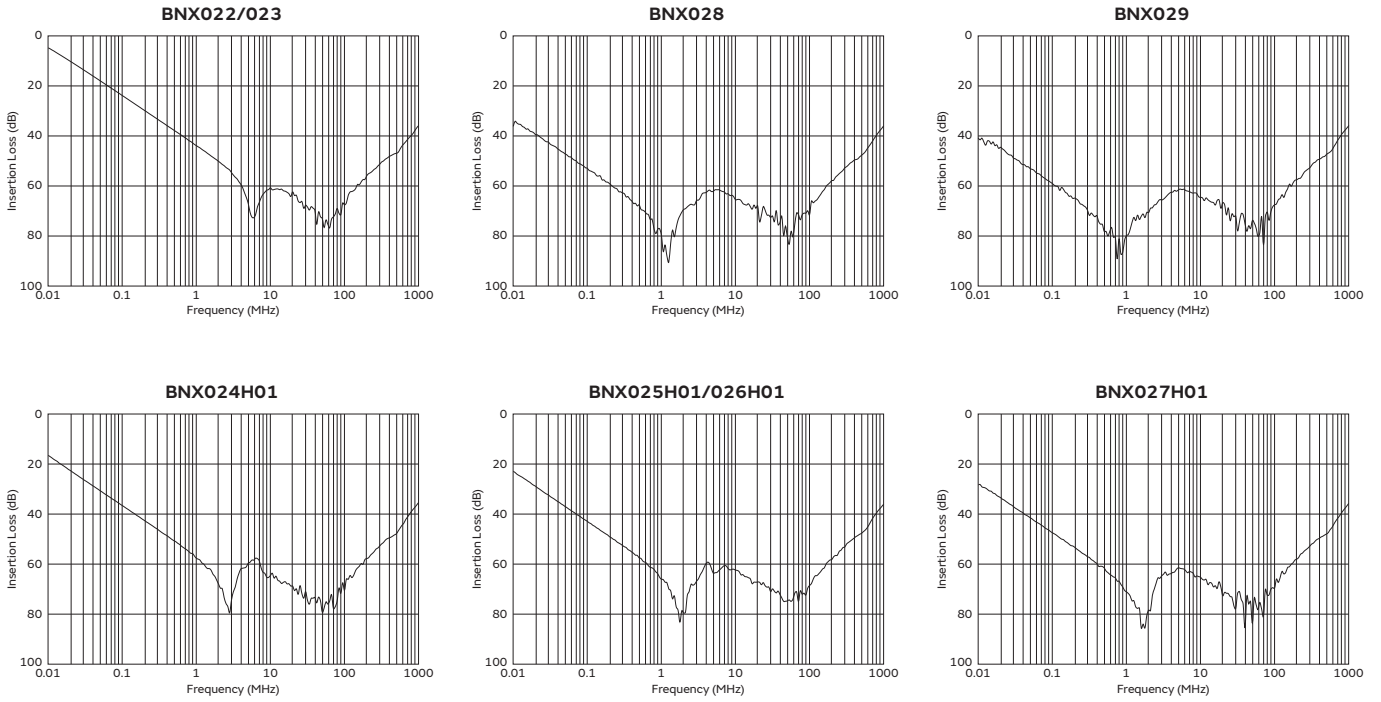

Derating of Rated Current

In operating temperature exceeding +85°C, derating of current is necessary for BNX022/023/029/024H/025H/026H/027H series. Please apply the derating curve shown in chart according to the operating temperature.

In operating temperature exceeding +65°C, derating of current is necessary for BNX028 series. Please apply the derating curve shown in chart according to the operating temperature.

Derating of Rated Current

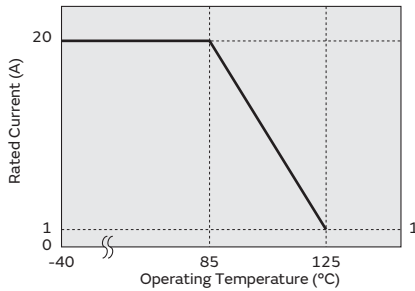

Derating of Rated Current

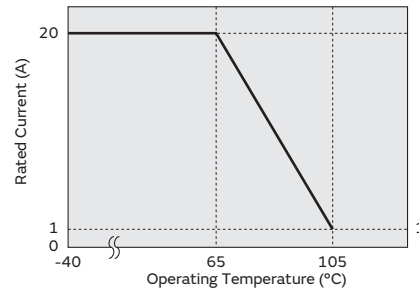

Block Type EMIFIL® BNX01□ Series

Appearance/Dimensions

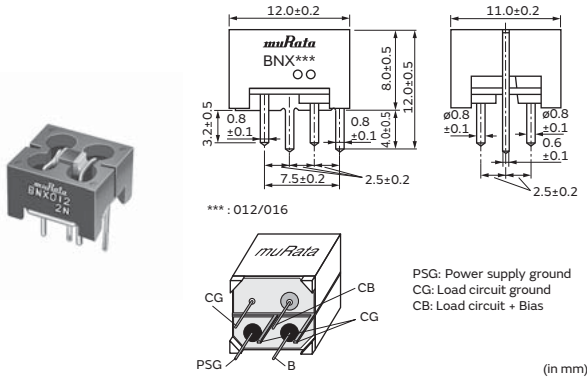

Packaging

Code	Packaging	Minimum Quantity
-	Box	150

Equivalent Circuit

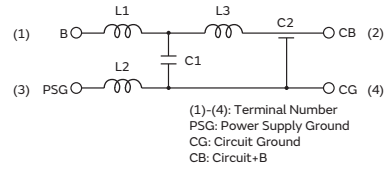

Rated Value

Part Number	Rated Voltage	Withstand Voltage	Rated Current	Insulation Resistance (min.)	Insertion Loss (Line impedance=50 ohm)
BNX012-01	50Vdc	125Vdc	15A	500M ohm	1MHz to 1GHz:40dB min.
BNX016-01	25Vdc	62.5Vdc	15A	50M ohm	100kHz to 1GHz:40dB min.

Operating Temperature Range: -40°C to 125°C

Insertion Loss Characteristics

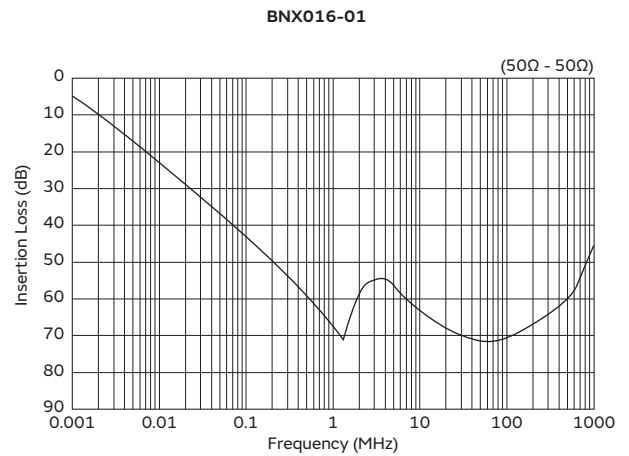
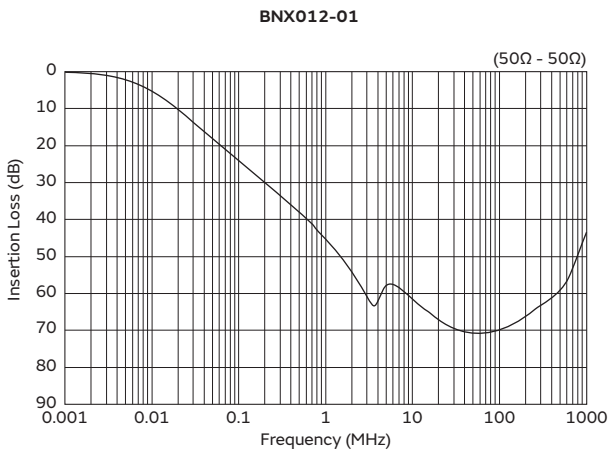

Continued on the following page. ↗

Continued from the preceding page. ↘

Derating of Rated Current

In operating temperature exceeding +85°C, derating of current is necessary for BNX01□ series. Please apply the derating curve shown in chart according to the operating temperature.

Derating of Rated Current

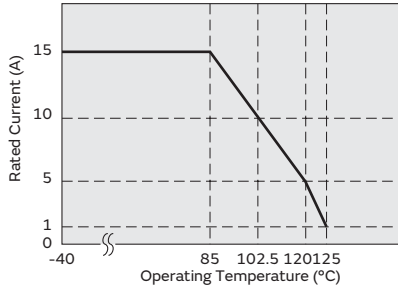

● Connecting ± power line

In case of using ± power line, please connect to each terminal as shown.

Power Supply (BNX Input)	BNX	Circuit (BNX Output)
Power Supply +Bias -	B CB	- Load Circuit +Bias
Power Supply Ground -	PSG CG	- Load Circuit Ground
Power Supply -Bias -	B CB	- Load Circuit -Bias
Power Supply Ground -	PSG CG	- Load Circuit Ground

Block Type EMIFIL[®] SMD Type (BNX) ⚠Caution/Notice

⚠Caution

Rating

Do not use products beyond the rated current and rated voltage as this may create excessive heat and deteriorate the insulation resistance.

Notice

Storage and Operating Conditions

<Operating Environment>

Do not use products in a chemical atmosphere such as chlorine gas, acid or sulfide gas.

Do not use products in an environment close to an organic solvent.

<Storage and Handling Requirements>

1. Storage Period

BNX series should be used within 12 months.

Solderability should be checked if this period is exceeded.

2. Storage Conditions

(1) Storage temperature: -10 to +40°C

Relative humidity: 15 to 85%

Avoid sudden changes in temperature and humidity.

(2) Do not store products in a chemical atmosphere such as chlorine gas, acid or sulfide gas.

Notice (Soldering and Mounting)

1. Cleaning

Do not clean BNX series (SMD Type).

Before cleaning, please contact Murata engineering.

2. Soldering

Reliability decreases with improper soldering methods.

Please solder by the standard soldering conditions shown in the mounting information.

3. Other

Noise suppression levels resulting from Murata's EMI suppression filters EMIFIL[®] may vary, depending on the circuits and ICs used, type of noise, mounting pattern, mounting location, and other operating conditions. Be sure to check and confirm in advance the noise suppression effect of each filter, in actual circuits, etc. before applying the filter in a commercial-purpose equipment design.

Handling

1. Resin Coating

Using resin for coating/molding products may affect the product's performance.

So please pay careful attention in selecting resin.

Prior to use, please make a reliability evaluation with the product mounted in your application set.

2. Handling of Substrates (for BNX02□)

After mounting products on a substrate, do not apply any stress to the product by bending or twisting the substrate

when cropping the substrate, inserting and removing a connector from the substrate or tightening a screw to the substrate.

Excessive mechanical stress may cause cracking in the product.

Bending

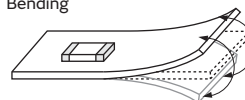

Twisting

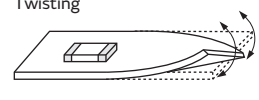

Block Type EMIFIL[®] Lead Type (BNX) ⚠Caution/Notice

⚠Caution

Rating

Do not use products beyond the rated current and rated voltage as this may create excessive heat and deteriorate the insulation resistance.

Notice

Storage and Operating Conditions

<Operating Environment>

1. Do not use products in a chemical atmosphere such as chlorine gas, acid or sulfide gas.
2. Do not use products near water, oil or organic solvents.

<Storage and Handling Requirements>

1. Storage Period

BNX Series should be used within 12 months.
Solderability should be checked if this period is exceeded.

2. Storage Conditions

- (1) Storage temperature: -10 to +40°C

Relative humidity: 15 to 85%

Avoid sudden changes in temperature and humidity.

- (2) Do not store products in a chemical atmosphere such as chlorine gas, acid or sulfide gas.

Notice (Soldering and Mounting)

1. Cleaning

Failure and degradation of a product can be caused by the cleaning method. When you clean in conditions that are not in the mounting information, please contact Murata engineering.

2. Soldering

Reliability decreases with improper soldering methods. Please solder by the standard soldering conditions shown in the mounting information.

3. Other

Noise suppression levels resulting from Murata's EMI suppression filters "EMIFIL" may vary, depending on the circuits and ICs used, type of noise, mounting pattern, lead wire length, mounting location, and other operating conditions. Be sure to check and confirm in advance the noise suppression effect of each filter, in actual circuits, etc. before applying the filter in a commercial-purpose equipment design.

Notice (Appearance)

In some cases, parts of the product surface have a whitish appearance; this is the result of the waxing process for humidity resistance improvement. This wax has no adverse effect on mechanical or electrical performance or on the reliability of the product.

Block Type EMIFIL[®] SMD Type (BNX) Soldering and Mounting

1. Standard Land Pattern Dimensions

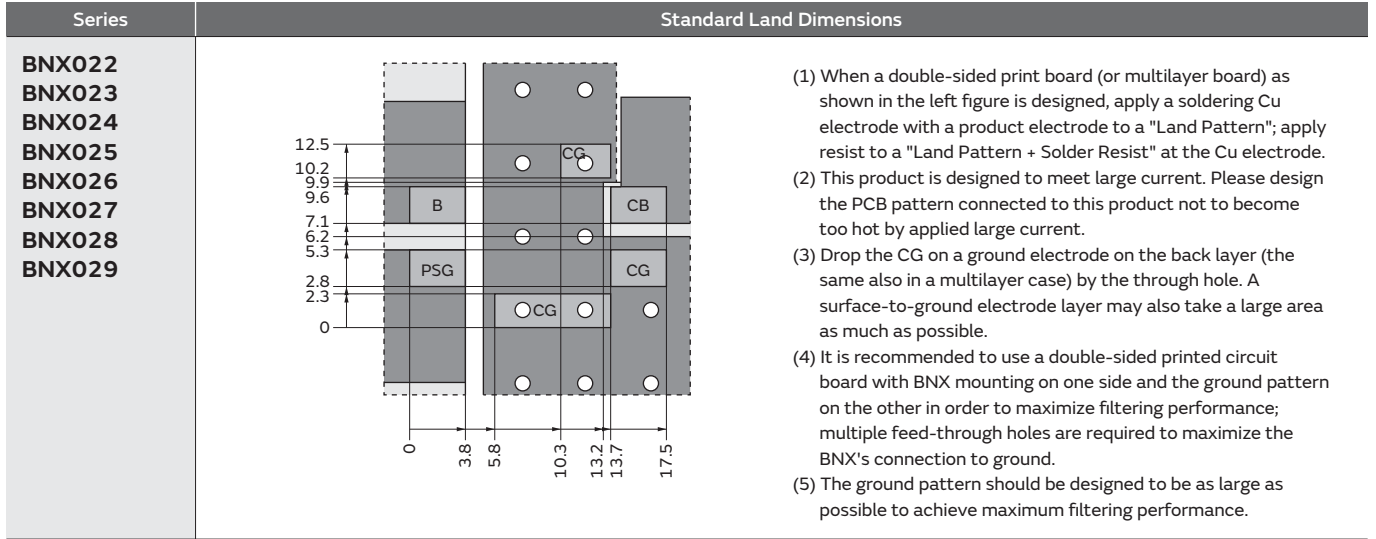

● PCB Warping (for BNX02□)

PCB should be designed so that products are not subjected to mechanical stress caused by warping the board.

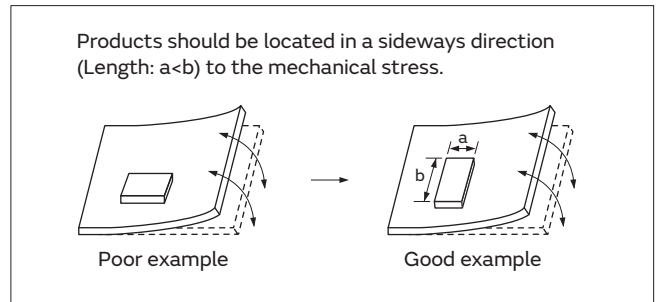

2. Solder Paste Printing and Adhesive Application

When reflow soldering the block type EMIFIL[®], the printing must be conducted in accordance with the following cream solder printing conditions.

If too much solder is applied, the chip will be prone to damage by mechanical and thermal stress from the PCB and may crack.

Standard land dimensions should be used for resist and copper foil patterns.

Series	Solder Paste Printing	Adhesive Application
BNX022 BNX023 BNX024 BNX025 BNX026 BNX027 BNX028 BNX029	<p>●Guideline of solder paste thickness: 150-200μm</p>	

Continued on the following page. ↗

Block Type EMIFIL[®] SMD Type (BNX) Soldering and Mounting

Continued from the preceding page. ↘

3. Standard Soldering Conditions

(1) Soldering Methods

- Use reflow soldering methods only.
- Use standard soldering conditions when soldering block type EMIFIL[®] SMD type.
- In cases where several different parts are soldered, each having different soldering conditions, use those conditions requiring the least heat and minimum time.

Solder: Use Sn-3.0Ag-0.5Cu solder. Use of Sn-Zn based solder will deteriorate performance of products.

Flux:

- Use rosin-based flux.
 In case of using RA type solder, products should be cleaned completely with no residual flux.
- Do not use strong acidic flux (with chlorine content exceeding 0.20wt%)
- Do not use water-soluble flux.

For additional mounting methods, please contact Murata.

(2) Soldering Profile

- Reflow Soldering Profile
 (Sn-3.0Ag-0.5Cu solder)

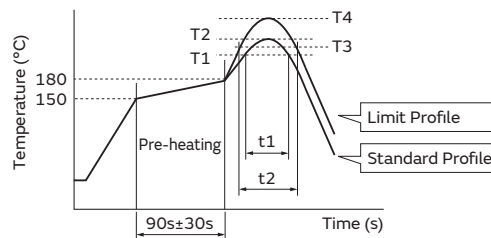

Series	Standard Profile				Limit Profile			
	Heating		Peak Temperature (T2)	Cycle of Reflow	Heating		Peak Temperature (T4)	Cycle of Reflow
	Temp. (T1)	Time (t1)			Temp. (T3)	Time (t2)		
BNX022/023/024/025/ 026/027/028/029	220°C min.	30 to 60s	250±3°C	2 times max.	230°C min.	60s max.	260°C/10s	2 times max.

(3) Reworking with a soldering Iron

- The following conditions must be strictly followed when using a soldering iron.
- Pre-heating: 150°C 60s min.
- Soldering iron power output: 100W max.
- Temperature of soldering iron tip / Soldering time / Times:
- 450°C max. / 5s max. / 2 time

Do not allow the tip of the soldering iron to directly contact the chip.
 For additional methods of reworking with a soldering iron, please contact Murata engineering.

4. Cleaning

Do not clean BNX022/023/024/025/026/027/028/029 series. In case of cleaning, please contact Murata engineering.

Block Type EMIFIL[®] Lead Type (BNX) Soldering and Mounting

1. Mounting Hole

■ Mounting holes should be designed as specified below.

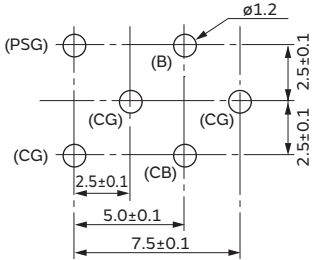
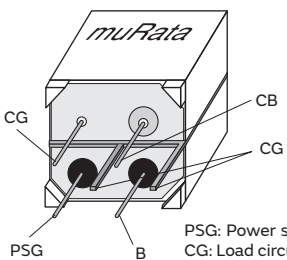
Series	Mounting Hole
BNX01□	<p>Component Side</p>  <p>Terminal Layout (Bottom figure)</p>  <p>PSG: Power supply ground CG: Load circuit ground CB: Load circuit + Bias</p>

2. Using the Block Type EMIFIL[®] (Lead Type) Effectively

(1) How to use effectively

This product effectively prevents undesired radiation and external noise from going out / entering the circuit by grounding the high frequency components that cause noise problems. Therefore, grounding conditions may affect the performance of the filter and attention should be paid to the following for effective use.

- Design maximized grounding area in the PCB, and grounding pattern for all the grounding terminals of the product to be connected. (Please follow the specified recommendations.)
- Minimize the distance between ground of the PCB and the ground plate of the product. (Recommend using the through hole connection between the grounding area both on the component side and the bottom side.)
- Insert the terminals into the holes on the PCB completely.
- Don't connect PSG terminal with CG terminal directly. (See the item 1. Terminal Layout)

(2) Self-heating

Though this product has a large rated current, localized self-heating may be caused depending on soldering conditions. To avoid this, attention should be paid to the following:

- Use a PCB with our recommendation on hole diameter / land pattern dimensions, mentioned in the right-hand drawing, especially for 4 terminals that pass current.
- Solder the terminals to the PCB with solder cover area at least 90%. Otherwise, excess self-heating at the connection between terminals and the PCB may lead to smoke and / or fire of the product even when operating at rated current.
- After installing this product in your product, please ensure that the self-heating is within the rated current recommended.

PCB Patterns

Use a bilateral PCB. Insert the BNX into the PCB until the root of the terminal is secured, then solder.

(1) Component Side View

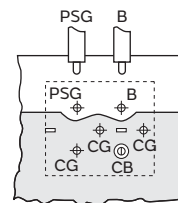

(2) Bottom View

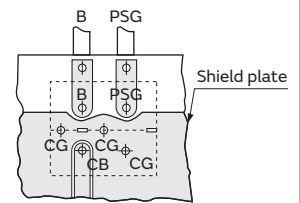

■ Copper foil pattern

Recommended Land Pattern

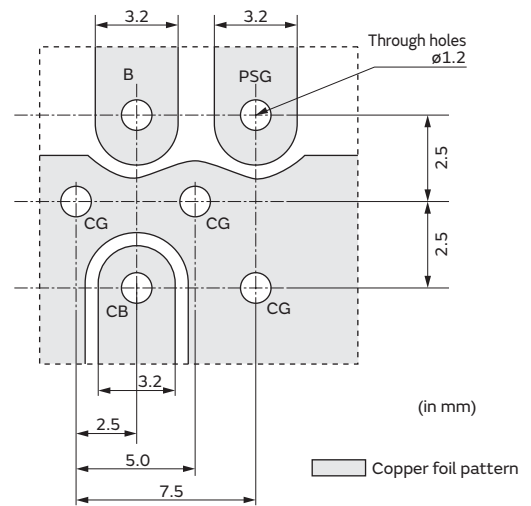

Continued on the following page. ↗

Block Type EMIFIL[®] Lead Type (BNX) Soldering and Mounting

Continued from the preceding page. ↘

3. Soldering

- (1) Use Sn-3.0Ag-0.5Cu solder.
- (2) Use rosin-based flux. Do not use strong acidic flux with halide content exceeding 0.2wt% (chlorine conversion value).
- (3) Products and the leads should not be subjected to any mechanical stress during the soldering process, or while subjected to the equivalent high temperatures.
- (4) Standard flow soldering profile

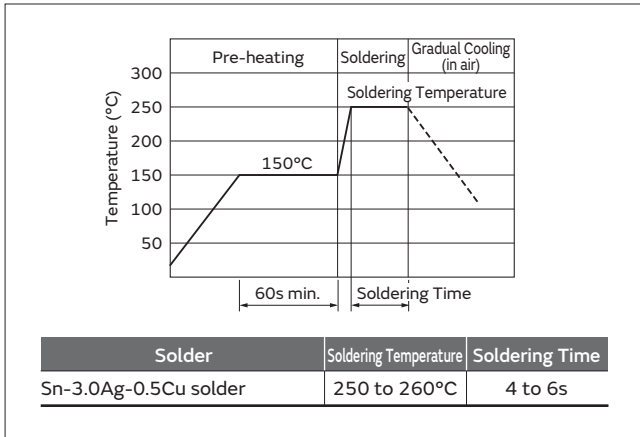

4. Cleaning

Clean the block Type EMIFIL[®](Lead Type) in the following conditions.

- (1) Cleaning temperature should be limited to 60°C max. (40°C max for alcohol type cleaner).
- (2) Ultrasonic cleaning should comply with the following conditions, avoiding the resonance phenomenon at the mounted products and PCB.
 Power: 20W/liter max.
 Frequency: 28 to 40kHz
 Time: 5 min. max.
- (3) Cleaner
 - (a) Alcohol type cleaner
 Isopropyl alcohol (IPA)
 - (b) Aqueous agent
 Pine Alpha ST-100S
- (4) There should be no residual flux or residual cleaner left after cleaning.
 In the case of using aqueous agent, products should be dried completely after rinsing with de-ionized water in order to remove the cleaner.
- (5) The surface of products may become dirty after cleaning, but there is no deterioration of mechanical or electrical characteristics or reliability.
- (6) Other cleaning: Please contact us.

Block Type EMIFIL[®] SMD Type (BNX) Packaging

Minimum Quantity and Dimensions of 24mm Width Embossed Tape

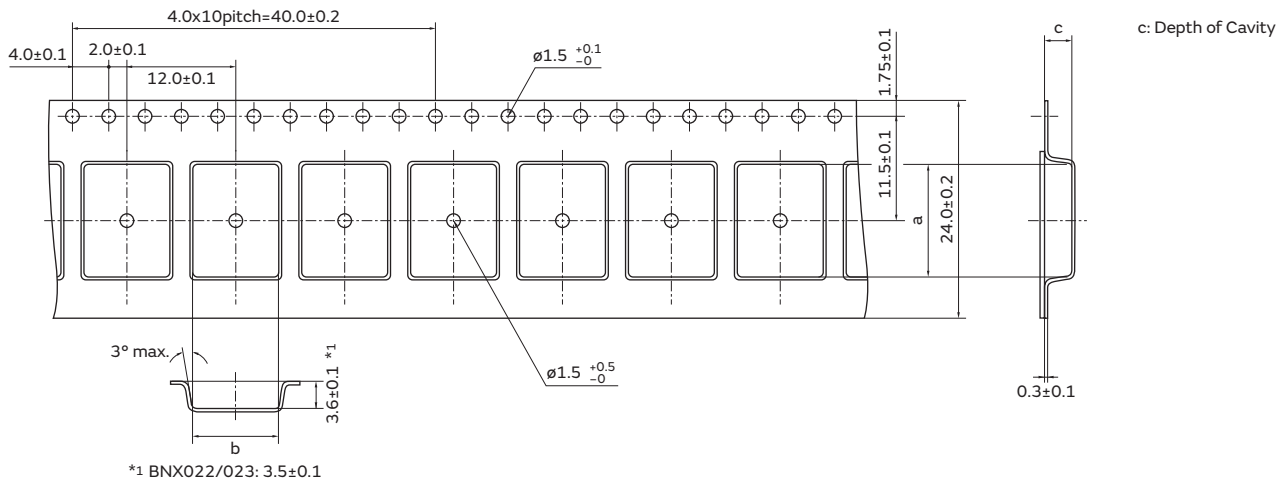

Dimension of the cavity is measured at the bottom side.

Part Number	Dimensions			Minimum Qty. (pcs.)		
	a	b	c	ø180mm Reel	ø330mm Reel	Bulk
BNX022/023	12.4	9.4	3.5	400	1500	100
BNX024/025/026/027/028/029	12.4	9.4	3.6			

(in mm)

"Minimum Quantity" means the number of units of each delivery or order. The quantity should be an integral multiple of the "Minimum Quantity."

EMC Absorber EA20/EA21 Series

Part Numbering	p268
Product Detail	p269
Notice	p270

● Part Numbering

EMC Absorber

(Part Number)

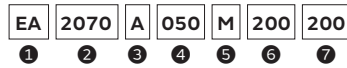

① Product ID

Product ID	
EA	EMC Absorber

② Sheet Type

Code	Sheet Type
2070	Metal Flake Powder (Halogen Free type)
2100	Metal Flake Powder (UL certified type)

③ Adhesive Tape Type

Code	Adhesive Tape Type
A	Standard tape type (Halogen Free type)
B	Thin adhesive tape type (Halogen Free type)

④ Outer Dimension Supplement Code

Expressed by 3 digits including the second decimal place in mm.

Ex.)

Code	Sheet Thickness
020	0.20mm

⑤ Unit of Dimension

One capital letter expresses Unit of Dimension (⑥) and Dimensions Length (⑦).

Code	Unit of Dimension
M	in mm (Standard)
C	in cm (Standard)

Standard shape is a rectangle.

Please contact us for other shapes.

⑥ Dimension (Length)

Expressed by 3 digits including the first decimal place.

⑦ Dimension (Width)

Expressed by 3 digits including the first decimal place.

Ex.)

Code	Dimension (Length × Width)
M300150	30.0×15.0 mm
C150100	15.0×10.0 cm

"Halogen Free" is defined to satisfy the following conditions for EMC Absorber listed in this catalog.

1. Chlorine will not exceed 900ppm.
2. Bromine will not exceed 900ppm.
3. The total amount of chlorine and bromine will not exceed 1500ppm.

EMC Absorber

EA20/EA21 Series

Appearance/Dimensions



Packaging

When inquiring, please contact us with size code, referring to "Part Numbering."

Rated Value

Part Number	Applicable Frequency (Typ.)	Thickness (Typ.)	Flame Class	Halogen	Operating Temperature Range
EA2070A050	0.1 to 3.0GHz	0.50mm	-	Halogen Free	-40°C to 120°C
EA2070A100	0.1 to 3.0GHz	1.00mm	-	Halogen Free	-40°C to 120°C
EA2070B010	0.1 to 3.0GHz	0.10mm	-	Halogen Free	-40°C to 120°C
EA2070B013	0.1 to 3.0GHz	0.13mm	-	Halogen Free	-40°C to 120°C
EA2070B020	0.1 to 3.0GHz	0.20mm	-	Halogen Free	-40°C to 120°C
EA2100A050	0.1 to 3.0GHz	0.50mm	UL94V-0	-	-40°C to 120°C
EA2100A100	0.1 to 3.0GHz	1.00mm	UL94V-0	-	-40°C to 120°C
EA2100B020	0.1 to 3.0GHz	0.20mm	UL94V-0	-	-40°C to 120°C

Magnetic Permeability-Reluctance

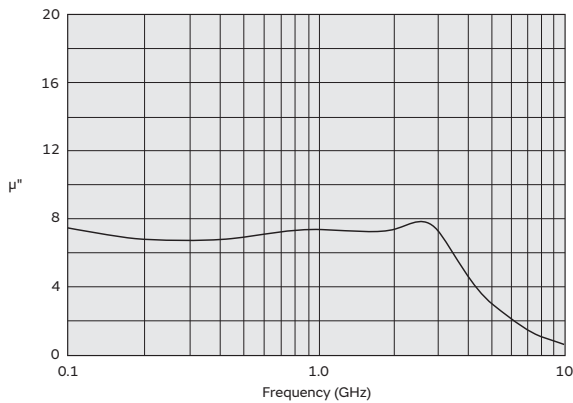

EMC Absorber (EA20/EA21) Notice

Notice

Storage and Operating Conditions

1. Adhesive Tape Stress

This product is designed to use adhesive tape to hold itself to the object.

And please avoid causing mechanical stress by bending or variation of the object.

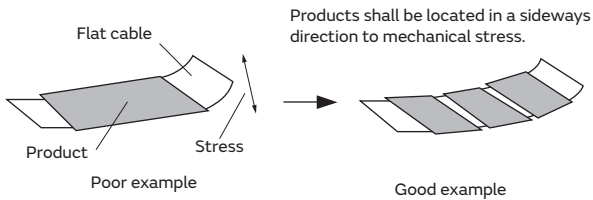

2. Cleaning

Avoid cleaning this product.

3. Handling of the Product

Adhesive tape must be clean to maintain the quality of adhesion.

Please wipe off any dirt, dust and any kind of oil from the surface of the object before use.

4. Storage Conditions

(1) Storage period

Products that were inspected by Murata over 6 months ago should be examined and used. This can be confirmed by the inspection number marked on the container.

Adhesiveness should be checked if this period is exceeded.

(2) Storage conditions

• Products should be stored in the warehouse in the following conditions:

Temperature: -10 to +40°C

Humidity: 30 to 70% relative humidity

No rapid change of temperature or humidity

• Products should be stored in the warehouse without heat shock condition, vibration, direct sunlight and so on.

Part Number Quick Reference

BLA2AAG	89	BLM18BB	65	DLW5AT_MQ2	233
BLA2ABB	90	BLM18BD	65	DLW5AT_SQ2	231
BLA2ABD	90	BLM18EG	107	DLW5AT_TQ2	234
BLA31AG	92	BLM18GG	109	DLW5BS_SQ2	229
BLA31BD	93	BLM18HB	103	DLW5BS_TQ2	235
BLE18PS	145	BLM18HD	103	DLW5BT_SQ2	236
BLE32PN	146	BLM18HE	103	DLW5BT_TQ2	237
BLF02JD	142	BLM18HG	103	EA20	269
BLF02RD	143	BLM18HK	103	EA21	269
BLF03JD	144	BLM18KG	57	LQW04CA_00	147
BLM02AX	29	BLM18PG	55	LQW15CA_00	148
BLM02BB	31	BLM18RK	69	LQW18CA_00	150
BLM02BC	31	BLM18SD	59	NFA18SD	181
BLM02BX	32	BLM18SG	59	NFA18SL	178
BLM02KX	28	BLM18SN	59	NFA21SL	182
BLM02PX	26	BLM18TG	64	NFE31PT	172
BLM03AG	36	BLM21AG	75	NFE61PT	173
BLM03AX	38	BLM21BB	77	NFL18SP	176
BLM03BB	39	BLM21BD	77	NFL18ST	174
BLM03BC	39	BLM21PG	71	NFL21SP	177
BLM03BD	39	BLM21RK	80	NFP0Q	226
BLM03BX	41	BLM21SN	73	NFW31SP	184
BLM03EB	96	BLM21SP	73	NFZ03SG	126
BLM03HB	94	BLM31KN	81	NFZ15SG	127
BLM03HD	94	BLM31PG	83	NFZ18SM	129
BLM03HG	94	BLM31SN	85	NFZ2HBM	133
BLM03PG	33	BLM41PG	86	NFZ2MSM	131
BLM03PX	34	BLT5BPT_LN1	88	NFZ32BW	135
BLM15AG	47	BNX01□	258	NFZ32SW	132
BLM15AX	48	BNX02□	256	NFZ5BBW	139
BLM15BA	50	DLMONS	203	PLT10HH	239
BLM15BB	50	DLMOQS	202	PLT5BPH	238
BLM15BC	50	DLM11G	205		
BLM15BD	50	DLM11S	206		
BLM15BX	53	DLPONS	208		
BLM15EG	99	DLP0QS	207		
BLM15EX	100	DLP11R	210		
BLM15GA	102	DLP11S	212		
BLM15GG	102	DLP11T	214		
BLM15HB	97	DLP1ND	216		
BLM15HD	97	DLP2AD	217		
BLM15HG	97	DLP31D	219		
BLM15KD	46	DLP31S	215		
BLM15PD	42	DLW21H	220		
BLM15PG	42	DLW21S	222		
BLM15PX	44	DLW31S	225		
BLM18AG	62	DLW44S	228		
BLM18BA	65	DLW5AH_SQ2	229		

Introduction of Related Catalog: Lead Type EMIFIL®

Please refer to catalog below for Lead Type EMIFIL®.

Lead Type EMIFIL®

EMI Suppression Filters (Lead Type EMIFIL®)

Contents

- Ferrite Beads Inductors
- Disc Type EMIFIL®
- EMIGUARD® (EMIFIL® with Varistor Function)
- Common Mode Choke Coils



Noise Suppression Basic Course

Use this course to improve your knowledge of various EMI suppression topics, including: noise emission mechanisms, conduction route, characteristics of electromagnetic noise.

https://www.murata.com/en-global/products/emc/emifil/knowhow/basic?intcid5=com_XXX_XXX_cmN_hd_XXX

Noise Suppression Basic Course

› Noise Suppression Basic Course Section 1

For engineers who are involved in noise suppression basic contents are compiled to understand noise suppression with suppression filter (EMIFIL®).

› Noise Suppression Basic Course Section 2

In Section 2, we will explain practical approaches and methods of noise suppression, deciding on themes as we proceed.

Noise Suppression Basic Course [Section 1]

For engineers who are involved in noise suppression, basic contents are compiled to understand noise suppression with EMI suppression filter (EMIFIL®).



Chapter 1

Reasons for requiring EMI suppression filters

Chapter 1 describes the reasons for using EMI suppression filter and explains how shields and filters used for electromagnetic noise suppression.

[Average time required for reading: approx.12 mins]



Chapter 2

Mechanism of Causing Electromagnetic Noise

In order to have a deep understanding of the mechanism of causing electromagnetic noise, Chapter 2 focuses on the issues regarding the noise source and the mechanism of noise occurrence such as how the noise occurs in the electric circuit.

[Average time required for reading: approx.47 mins]

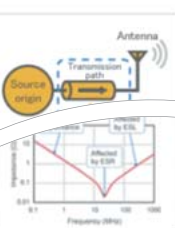

Chapter 3

Factors of making noise problems complex

In order to handle the noise interference for electronic devices, it is necessary to understand not only the noise source origin, but also the characteristics of the noise paths and antennas. Among these topics, Chapter 3 describes the factors of making noise problems complex.

[Average time required for reading: approx.50 mins]

EMI suppression filter

Chapter 6 describes the typical characteristics of EMI suppression filters, and the actual characteristics of electronic components.

[Average time required for reading: approx.55 mins]

Chapter 1

Reasons for requiring EMI suppression filters (EMIFIL®)

1-1. Introduction

An EMI suppression filter (EMIFIL®) is an electronic component for providing electromagnetic noise suppression for electronic devices and is used in conjunction with shields and other protection. This filter only extracts and removes components that can cause electromagnetic noise from electric currents that are conducted through wiring. Chapter 1 describes the reasons for using EMI suppression filters (EMIFIL®) in electronic devices and also provides an overview of the operations of shields and filters that are typical parts used for electromagnetic noise suppression.



Fig. 1-1 EMI suppression filters (EMIFIL®)

• Top of page

Noise Suppression Basic Course [Section 2]

In Section 2, we will explain practical approaches and methods of noise suppression, deciding on themes as we proceed.



Theme 1

Proper Use of Noise Suppression Products for Digital Circuits

To resolve the problem of noise inflicted onto radios, TVs, and other devices, EMI suppression filters have become widely used. This theme provides examples of the proper use of typical EMI suppression filters: capacitors, ferrite beads. Also, this theme explains the reason why the noise suppression effect varies among sets.

[Average time required for reading: approx.21 mins]

Theme 1

Noise suppression in digital signal lines

1-1. Introduction

During my university days, there was always noise coming from my FM radio whenever I listened to it beside my PC. The radiation noise from the PC entered and hindered the FM radio. At that time, I didn't know the cause and never even dreamed that I would face this problem after joining the company. When I started actual work on noise suppression, it was so difficult that it took several months in some cases. The major reasons are as follows:

- (1) It is unknown where the noise is generated from (noise source) and how it is conducted
- (2) Appropriate noise suppression methods are difficult to grasp

When the correct noise suppression method was unknown, various things crossed my mind: for example, maybe the part dealt with at that time was wrong and I should deal with another part. It is not rare that a noise suppression method effective for a set, such as filtering, is not effective for another set, which left me scratching my head.

Therefore, I felt the necessity for organized theoretical noise suppression methods, and correct filter selection methods. As part of my research, I investigated the causes and other factors of the difference in the noise suppression effect on the same noise filter depending on the circuit, and summarized them as specific examples. This document describes the contents.



Global Locations

For details please visit www.murata.com



⚠ Note

1 Export Control

For customers outside Japan:

No Murata products should be used or sold, through any channels, for use in the design, development, production, utilization, maintenance or operation of, or otherwise contribution to (1) any weapons (Weapons of Mass Destruction [nuclear, chemical or biological weapons or missiles] or conventional weapons) or (2) goods or systems specially designed or intended for military end-use or utilization by military end-users.

For customers in Japan:

For products which are controlled items subject to the "Foreign Exchange and Foreign Trade Law" of Japan, the export license specified by the law is required for export.

2 Please contact our sales representatives or product engineers before using the products in this catalog for the applications listed below, which require especially high reliability for the prevention of defects which might directly damage a third party's life, body or property, or when one of our products is intended for use in applications other than those specified in this catalog.

- ① Aircraft equipment
- ② Aerospace equipment
- ③ Undersea equipment
- ④ Power plant equipment
- ⑤ Medical equipment
- ⑥ Transportation equipment (vehicles, trains, ships, etc.)
- ⑦ Traffic signal equipment
- ⑧ Disaster prevention / crime prevention equipment
- ⑨ Data-processing equipment
- ⑩ Application of similar complexity and/or reliability requirements to the applications listed above

3 Product specifications in this catalog are as of September 2018. They are subject to change or our products in it may be discontinued without advance notice. Please check with our sales representatives or product engineers before ordering. If there are any questions, please contact our sales representatives or product engineers.

4 Please read rating and ⚠CAUTION (for storage, operating, rating, soldering, mounting and handling) in this catalog to prevent smoking and/or burning, etc.

5 This catalog has only typical specifications. Therefore, please approve our product specifications or transact the approval sheet for product specifications before ordering.

6 Please note that unless otherwise specified, we shall assume no responsibility whatsoever for any conflict or dispute that may occur in connection with the effect of our and/or a third party's intellectual property rights and other related rights in consideration of your use of our products and/or information described or contained in our catalogs. In this connection, no representation shall be made to the effect that any third parties are authorized to use the rights mentioned above under licenses without our consent.

7 No ozone depleting substances (ODS) under the Montreal Protocol are used in our manufacturing process.

Murata Manufacturing Co., Ltd.

www.murata.com

muRata
INNOVATOR IN ELECTRONICS

Mouser Electronics

Authorized Distributor

Click to View Pricing, Inventory, Delivery & Lifecycle Information:

Murata:

[BLM15BD421PN1D](#) [BLM31AF700SH1L](#) [BLM31BE601SH1L](#) [BLM41PG101SN1L](#) [NFE31PT222Z1E9L](#)
[NFE31PT471F1E9L](#) [NFE61HT332Z2A9L](#) [NFE61HT181C2A9L](#) [NFE61PT361B1H9L](#) [DLW5BSN152SQ2L](#)
[DLW5BSN191SQ2L](#) [DLW5BSN102SQ2L](#) [DLW5BSN302SQ2L](#) [BLM15BD601PN1D](#) [NFE31PT470C1E9L](#)
[DLW5BSN351SQ2L](#) [NFE61HT330U2A9L](#) [BLM15AG102AN1D](#) [BLM15AG601AN1D](#) [NFE61HT102F2A9B](#)
[NFW31SP106X1E4L](#) [BLM31BE601FN1L](#) [NFE61PT680B1H9L](#) [BLM15AG601PN1D](#) [NFR21GD4706802L](#)
[NFE31PT220R1E9L](#) [BLM41PF800SN1L](#) [BLM41AF151SN1L](#) [NFR21GD1002202L](#) [NFR21GD4702202L](#)
[NFL21SP206X1C3D](#) [NFE61PT681B1H9L](#) [NFE61PT181B1H9L](#) [BLM15BD102PN1D](#) [NFE61PT101Z1H9L](#)
[BLM41AF800SN1B](#) [NFR21GD1016802L](#) [NFE61HT332Z2A9B](#) [NFR21GD1004702L](#) [BLM31AJ601SN1L](#)
[NFE61PT330B1H9L](#) [BLM18PG600SN1B](#) [BLM18PG300SN1B](#) [NFR21GD1011012L](#) [NFW31SP506X1E4L](#)
[BLM41AF800SN1L](#) [NFW31SP206X1E4L](#) [BLM18HD601SN1B](#) [BLM18HG601SN1B](#) [BLM15AG700PN1D](#)
[BLM15AG100PN1D](#) [NFM46P11C155T1-X](#) [DLW5BTN102SQ2L](#) [DLW5BTN142SQ2L](#) [DLW5BTN251SQ2L](#)
[DLW5BTN501SQ2L](#) [NFE31PT471F1E9B](#) [NFE61PT361B1H9B](#) [DLW5BSN102SQ2B](#) [BLM41PG750AN1L](#)
[BLM18SG221TN1B](#) [BLM15AG221SN1D-1](#) [NFR21GD4704702L](#) [NFE61PT472C1H9B](#) [NFE61HT681D2A9L](#)
[NFE61HT361C2A9L](#) [BLM15BB750PN1D](#) [DLM2HGN601SZ3L](#) [NFR21GD1012202L](#) [BLM15BB221PN1D](#)
[BLM18HG102SN1B](#) [NFR21GD4701012L](#) [BLM15AG121PN1D](#) [BLM31BE601SN1L](#) [BLM18AG121SN1B](#)
[BLM18AG221SN1B](#) [BLM31AF700SN1B](#) [NFE61HT680R2A9L](#) [NFE31PT221D1E9L](#) [NFE61PT102E1H9L](#)
[BLM18BD601SN1B](#) [NFE61HT101Z2A9L](#) [NFE31PT101C1E9L](#) [BLM18AG601SN1B](#) [BLM31AJ601SN1B](#)
[NFW31SP407X1E4L](#) [NFW31SP207X1E4L](#) [NFW31SP307X1E4L](#) [NFW31SP157X1E4L](#) [NFW31SP107X1E4L](#)
[NFW31SP507X1E4L](#) [NFE31PT152Z1E9L](#) [BLM31AJ260SN1L](#) [NFE61HT102F2A9L](#) [NFR21GD1014702L](#)
[DLP31DN161SL4L](#) [DLP31DN361SL4L](#) [NFE61PT472C1H9L](#) [BLM02AG100SN1D](#) [BLM02AG121SN1D](#)