

P-Channel Enhancement Mode Field Effect Transistor

NDT2955

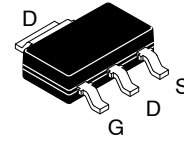

SOT-223
CASE 318H-01

General Description

This 60 V P-Channel MOSFET is produced using onsemi's high voltage Trench process. It has been optimized for power management applications.

Features

- 2.5 A, -60 V
 - $R_{DS(ON)} = 300\text{ m}\Omega @ V_{GS} = -10\text{ V}$
 - $R_{DS(ON)} = 500\text{ m}\Omega @ V_{GS} = -4.5\text{ V}$
- High Density Cell Design for Extremely Low $R_{DS(ON)}$.
- High Power and Current Handling Capability in a Widely Used Surface Mount Package
- This is a Pb-Free Device

Applications

- DC/DC Converter
- Power Management

ABSOLUTE MAXIMUM RATINGS ($T_A = 25^\circ\text{C}$, unless otherwise noted)

Symbol	Parameter	Value	Unit	
V_{DSS}	Drain-Source Voltage	-60	V	
V_{GSS}	Gate-Source Voltage	± 20	V	
I_D	Drain Current	- Continuous (Note 1a)	-2.5	
		- Pulsed	-15	
P_D	Maximum Power Dissipation (Note 1a)	3.0	W	
		(Note 1b)		1.3
		(Note 1c)		1.1
T_J, T_{STG}	Operating and Storage Temperature Range	-55 to +150	$^\circ\text{C}$	

Stresses exceeding those listed in the Maximum Ratings table may damage the device. If any of these limits are exceeded, device functionality should not be assumed, damage may occur and reliability may be affected.

THERMAL CHARACTERISTICS ($T_A = 25^\circ\text{C}$, unless otherwise noted)

Symbol	Parameter	Max	Unit
$R_{\theta JA}$	Thermal Resistance, Junction-to-Ambient (Note 1a)	42	$^\circ\text{C}/\text{W}$
$R_{\theta JC}$	Thermal Resistance, Junction-to-Case (Note 1)	12	$^\circ\text{C}/\text{W}$

MARKING DIAGRAM

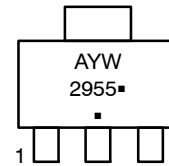

A = Assembly Location
Y = Year
W = Work Week
2955 = Specific Device Code
▪ = Pb-Free Package

(Note: Microdot may be in either location)

PINOUT DIAGRAM

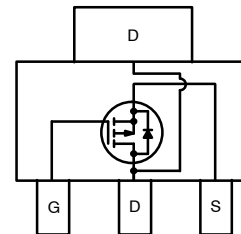

ORDERING INFORMATION

Device	Package	Shipping [†]
NDT2955	SOT-223 (Pb-Free)	4000 / Tape & Reel

[†]For information on tape and reel specifications, including part orientation and tape sizes, please refer to our Tape and Reel Packaging Specifications Brochure, [BRD8011/D](#).

NDT2955

ELECTRICAL CHARACTERISTICS (T_A = 25°C unless otherwise noted)

Symbol	Parameter	Conditions	Min	Typ	Max	Unit
--------	-----------	------------	-----	-----	-----	------

AVALANCHE RATINGS

W _{DSS}	Drain-Source Avalanche Energy	Single Pulse, V _{DD} = 30 V, I _D = 2.5 A	-	-	174	mJ
------------------	-------------------------------	--	---	---	-----	----

OFF CHARACTERISTICS

BV _{DSS}	Drain-Source Breakdown Voltage	V _{GS} = 0 V, I _D = -250 μA	-60	-	-	V
$\frac{\Delta BV_{DSS}}{\Delta T_J}$	Breakdown Voltage Temperature Coefficient	I _D = -250 μA, Referenced to 25°C	-	-60	-	mV/°C
I _{DSS}	Zero Gate Voltage Drain Current	V _{DS} = -60 V, V _{GS} = 0 V	-	-	-10	μA
I _{GSSF}	Gate-Body Leakage, Forward	V _{GS} = -20 V, V _{DS} = 0 V	-	-	100	nA
I _{GSSR}	Gate-Body Leakage, Reverse	V _{GS} = -20 V, V _{DS} = 0 V	-	-	-100	nA

ON CHARACTERISTICS (Note 2)

V _{GS(th)}	Gate Threshold Voltage	V _{DS} = V _{GS} , I _D = -250 μA	-2	-2.6	-4	V
$\frac{\Delta V_{GS(th)}}{\Delta T_J}$	Gate Threshold Voltage Temperature Coefficient	I _D = -250 μA, Referenced to 25°C	-	5.7	-	mV/°C
R _{DS(on)}	Static Drain-Source On-Resistance	V _{GS} = -10 V, I _D = -2.5 A	-	95	300	mΩ
		V _{GS} = -4.5 V, I _D = -2 A	-	163	500	
		V _{GS} = -10 V, I _D = -2.5 A, T _J = 125°C	-	153	513	
I _{D(on)}	On-State Drain Current	V _{GS} = -10 V, V _{DS} = -5 V	-12	-	-	A
g _{FS}	Forward Transconductance	V _{DS} = -10 V, I _D = -2.5 A	-	5.5	-	S

DYNAMIC CHARACTERISTICS

C _{iss}	Input Capacitance	V _{DS} = -30 V, V _{GS} = 0 V, f = 1.0 MHz	-	601	-	pF
C _{oss}	Output Capacitance		-	85	-	pF
C _{rss}	Reverse Transfer Capacitance		-	35	-	pF

SWITCHING CHARACTERISTICS (Note 2)

t _{d(on)}	Turn - On Delay Time	V _{DD} = -30 V, I _D = -1 A, V _{GS} = -10 V, R _{GEN} = 6 Ω	-	12	21	ns
t _r	Turn - On Rise Time		-	10	20	ns
t _{d(off)}	Turn - Off Delay Time		-	19	34	ns
t _f	Turn - Off Fall Time		-	6	12	ns
Q _g	Total Gate Charge	V _{DS} = -30 V, I _D = -2.5 A, V _{GS} = -10 V	-	11	15	nC
Q _{gs}	Gate-Source Charge		-	2.4	-	nC
Q _{gd}	Gate-Drain Charge		-	2.7	-	nC

DRAIN-SOURCE DIODE CHARACTERISTICS AND MAXIMUM RATINGS

I _S	Maximum Continuous Drain-Source Diode Forward Current	-	-	-2.5	A	
V _{SD}	Drain-Source Diode Forward Voltage	V _{GS} = 0 V, I _S = -2.5 A (Note 2)	-	-0.8	-1.2	V
t _{rr}	Diode Reverse Recovery Time	I _F = -2.5 A, d _{I_F}/d_t = 100 A/μs}	-	25	-	ns
Q _{rr}	Diode Reverse Recovery Charge		-	40	-	nC

Product parametric performance is indicated in the Electrical Characteristics for the listed test conditions, unless otherwise noted. Product performance may not be indicated by the Electrical Characteristics if operated under different conditions.

1. R_{θJA} is the sum of the junction-to-case and case-to-ambient thermal resistance where the case thermal reference is defined as the solder mounting surface of the drain pins. R_{θJC} is guaranteed by design while R_{θCA} is determined by the user's board design.

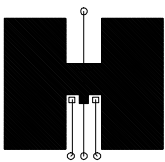

a. 42°C/W when mounted on a 1 in² pad of 2 oz copper.



b. 95°C/W when mounted on a 0.066 in² pad of 2 oz copper.

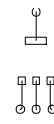

c. 110°C/W when mounted on a minimum pad.

2. Pulse Test: Pulse Width < 300 μs, Duty Cycle < 2.0%.

TYPICAL CHARACTERISTICS

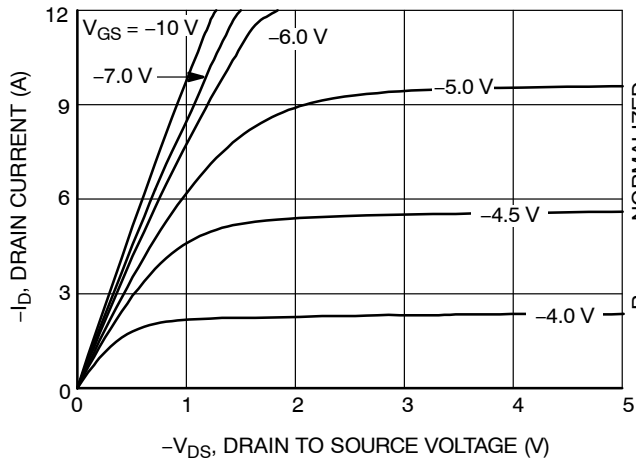

Figure 1. On-Region Characteristics

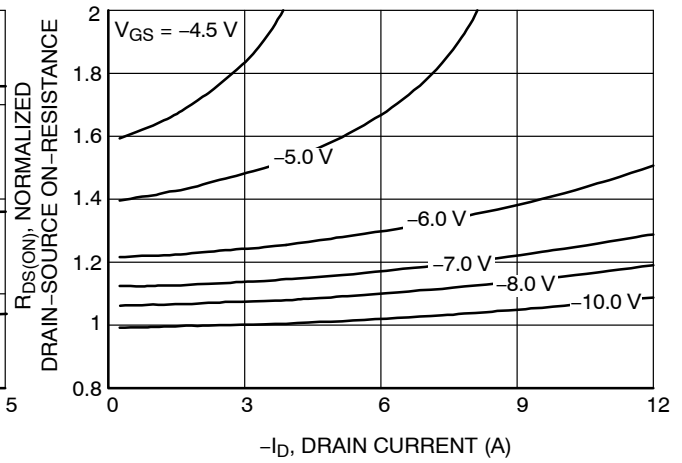

Figure 2. On-Resistance Variation with Drain Current and Gate Voltage

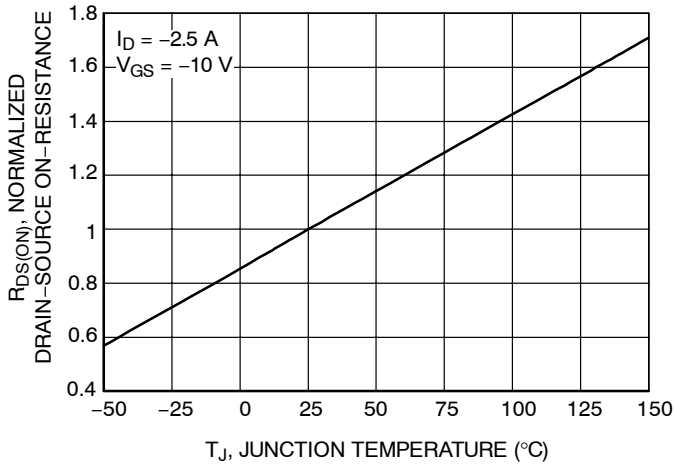

Figure 3. On-Resistance Variation with Temperature

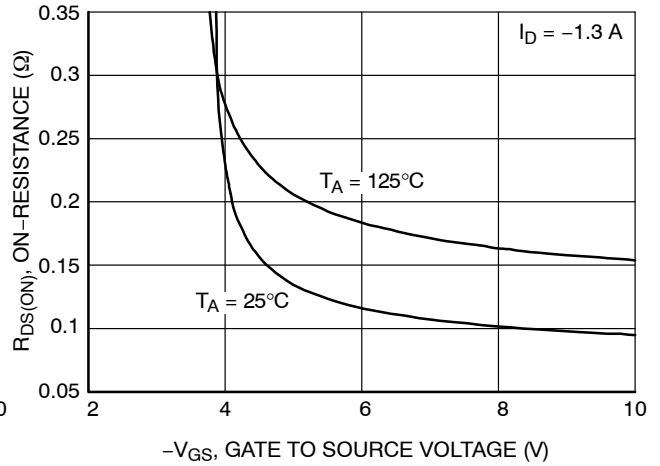

Figure 4. On-Resistance Variation with Gate-to-Source Voltage

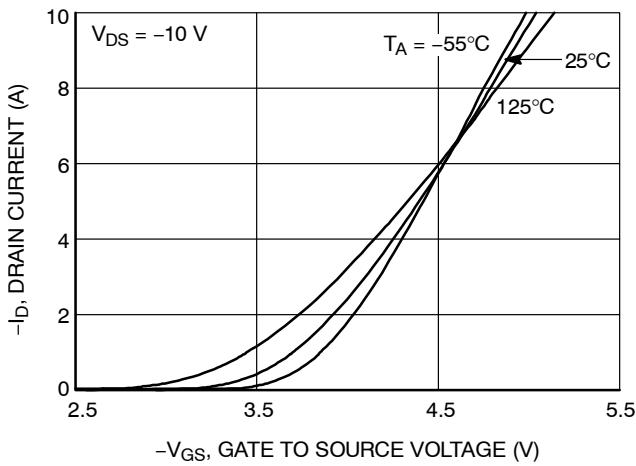

Figure 5. Transfer Characteristics

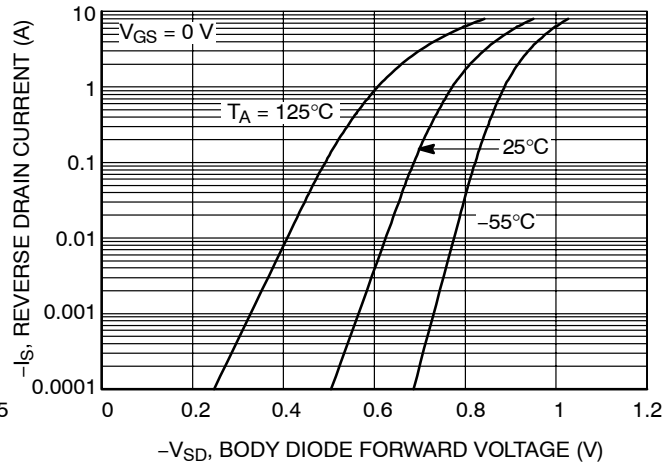
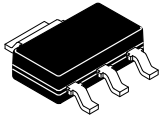

Figure 6. Body Diode Forward Voltage Variation with Source Current and Temperature



SCALE 2:1

SOT-223
CASE 318H
ISSUE B

DATE 13 MAY 2020

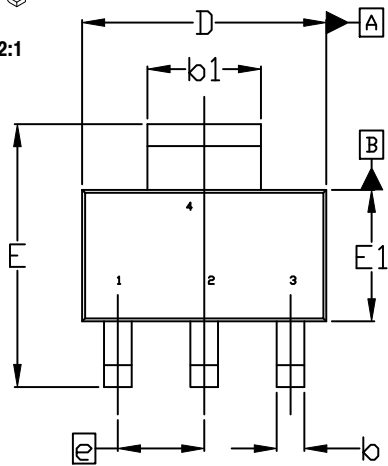

TOP VIEW

$\text{C} \text{ A} \text{ B}$

NOTE 7

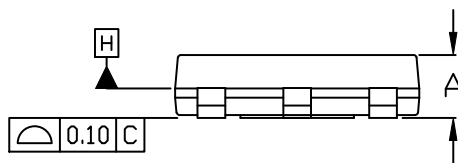

SIDE VIEW

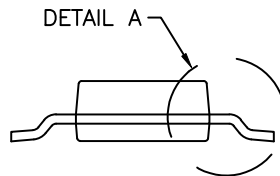

END VIEW

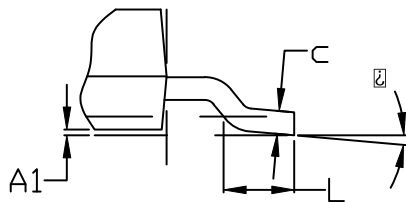

DETAIL A

NOTES:

1. DIMENSIONING AND TOLERANCING PER ASME Y14.5M, 2009.
2. CONTROLLING DIMENSION: MILLIMETERS
3. DIMENSIONS D & E1 ARE DETERMINED AT DATUM H. DIMENSIONS DO NOT INCLUDE MOLD FLASH, PROTRUSIONS OR GATE BURRS. SHALL NOT EXCEED 0.23mm PER SIDE.
4. LEAD DIMENSIONS b AND b1 DO NOT INCLUDE DAMBAR PROTRUSION. ALLOWABLE DAMBAR PROTRUSION IS 0.08mm PER SIDE.
5. DATUMS A AND B ARE DETERMINED AT DATUM H.
6. A1 IS DEFINED AS THE VERTICAL DISTANCE FROM THE SEATING PLANE TO THE LOWEST POINT OF THE PACKAGE BODY.
7. POSITIONAL TOLERANCE APPLIES TO DIMENSIONS b AND b1.

DIM	MILLIMETERS		
	MIN.	NOM.	MAX.
A	---	---	1.80
A1	0.02	0.06	0.11
b	0.60	0.74	0.88
b1	2.90	3.00	3.10
c	0.24	---	0.35
D	6.30	6.50	6.70
E	6.70	7.00	7.30
E1	3.30	3.50	3.70
e	2.30 BSC		
L	0.25	---	---
C	0°	---	10°

GENERIC MARKING DIAGRAM*

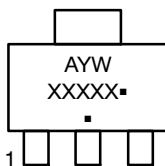

- A = Assembly Location
- Y = Year
- W = Work Week
- XXXXX = Specific Device Code
- = Pb-Free Package

(Note: Microdot may be in either location)

*This information is generic. Please refer to device data sheet for actual part marking. Pb-Free indicator, "G" or microdot "▪", may or may not be present. Some products may not follow the Generic Marking.

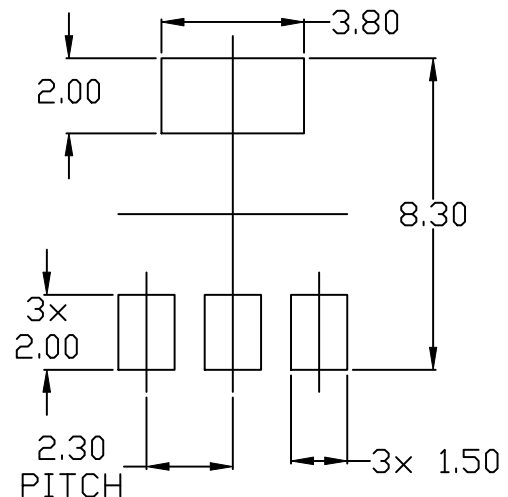

RECOMMENDED MOUNTING FOOTPRINT

* For additional information on our Pb-Free strategy and soldering details, please download the ON Semiconductor Soldering and Mounting Techniques Reference Manual, SOLDERM/D.

DOCUMENT NUMBER:	98ASH70634A	Electronic versions are uncontrolled except when accessed directly from the Document Repository. Printed versions are uncontrolled except when stamped "CONTROLLED COPY" in red.
DESCRIPTION:	SOT-223	PAGE 1 OF 1

onsemi and ONSEMI are trademarks of Semiconductor Components Industries, LLC dba onsemi or its subsidiaries in the United States and/or other countries. onsemi reserves the right to make changes without further notice to any products herein. onsemi makes no warranty, representation or guarantee regarding the suitability of its products for any particular purpose, nor does onsemi assume any liability arising out of the application or use of any product or circuit, and specifically disclaims any and all liability, including without limitation special, consequential or incidental damages. onsemi does not convey any license under its patent rights nor the rights of others.

onsemi, **Onsemi**, and other names, marks, and brands are registered and/or common law trademarks of Semiconductor Components Industries, LLC dba "**onsemi**" or its affiliates and/or subsidiaries in the United States and/or other countries. **onsemi** owns the rights to a number of patents, trademarks, copyrights, trade secrets, and other intellectual property. A listing of **onsemi**'s product/patent coverage may be accessed at www.onsemi.com/site/pdf/Patent-Marking.pdf. **onsemi** reserves the right to make changes at any time to any products or information herein, without notice. The information herein is provided "as-is" and **onsemi** makes no warranty, representation or guarantee regarding the accuracy of the information, product features, availability, functionality, or suitability of its products for any particular purpose, nor does **onsemi** assume any liability arising out of the application or use of any product or circuit, and specifically disclaims any and all liability, including without limitation special, consequential or incidental damages. Buyer is responsible for its products and applications using **onsemi** products, including compliance with all laws, regulations and safety requirements or standards, regardless of any support or applications information provided by **onsemi**. "Typical" parameters which may be provided in **onsemi** data sheets and/or specifications can and do vary in different applications and actual performance may vary over time. All operating parameters, including "Typicals" must be validated for each customer application by customer's technical experts. **onsemi** does not convey any license under any of its intellectual property rights nor the rights of others. **onsemi** products are not designed, intended, or authorized for use as a critical component in life support systems or any FDA Class 3 medical devices or medical devices with a same or similar classification in a foreign jurisdiction or any devices intended for implantation in the human body. Should Buyer purchase or use **onsemi** products for any such unintended or unauthorized application, Buyer shall indemnify and hold **onsemi** and its officers, employees, subsidiaries, affiliates, and distributors harmless against all claims, costs, damages, and expenses, and reasonable attorney fees arising out of, directly or indirectly, any claim of personal injury or death associated with such unintended or unauthorized use, even if such claim alleges that **onsemi** was negligent regarding the design or manufacture of the part. **onsemi** is an Equal Opportunity/Affirmative Action Employer. This literature is subject to all applicable copyright laws and is not for resale in any manner.

ADDITIONAL INFORMATION

TECHNICAL PUBLICATIONS:

Technical Library: www.onsemi.com/design/resources/technical-documentation
onsemi Website: www.onsemi.com

ONLINE SUPPORT: www.onsemi.com/support

For additional information, please contact your local Sales Representative at www.onsemi.com/support/sales