

THIS DRAWING IS UNPUBLISHED. RELEASED FOR PUBLICATION
 © COPYRIGHT - By - ALL RIGHTS RESERVED.

LOC		DIST		REVISIONS			
P	LTR	DESCRIPTION		DATE	DWN	APVD	
AD	39	S2	REVISED PER ECO-11-010839	25MAY11	RK	HMR	

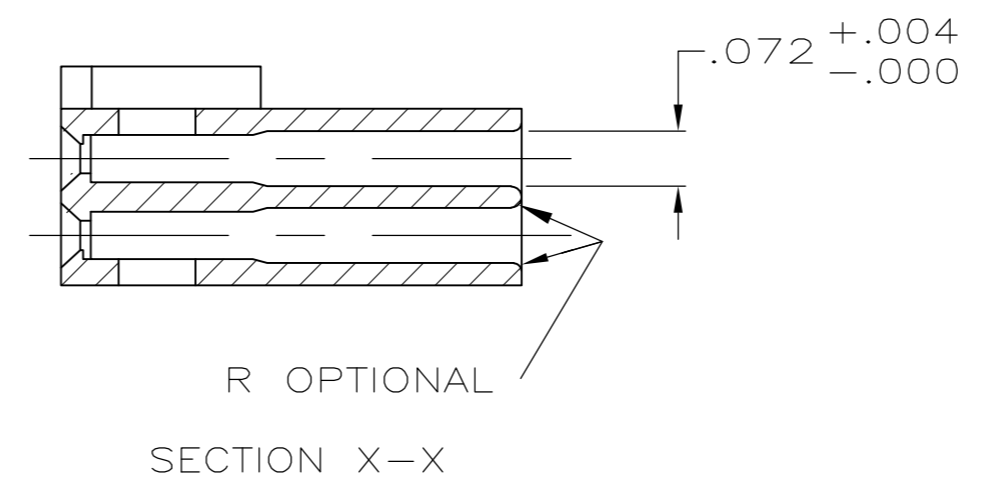
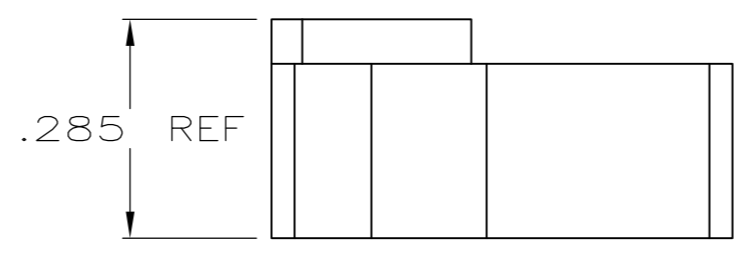
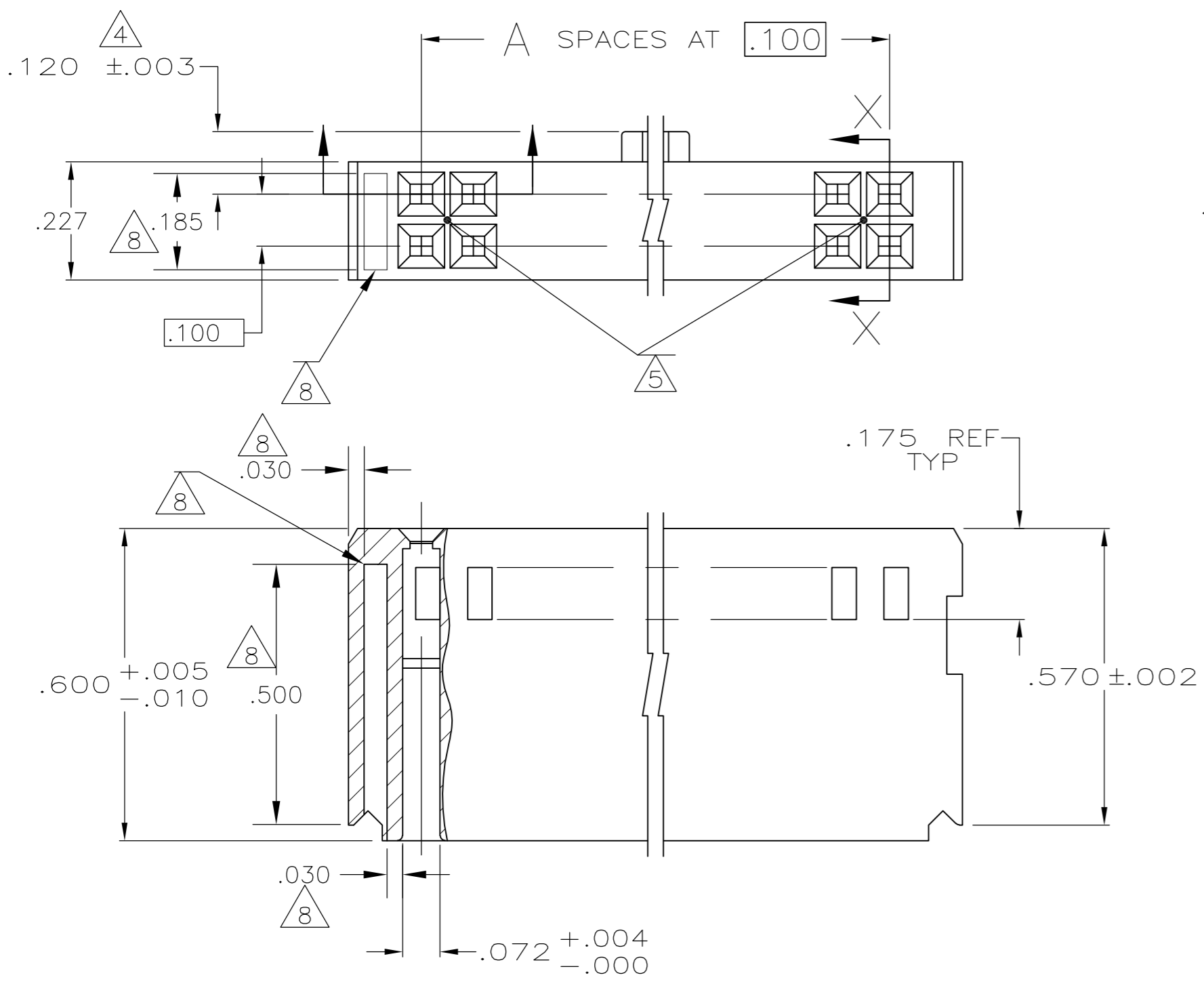
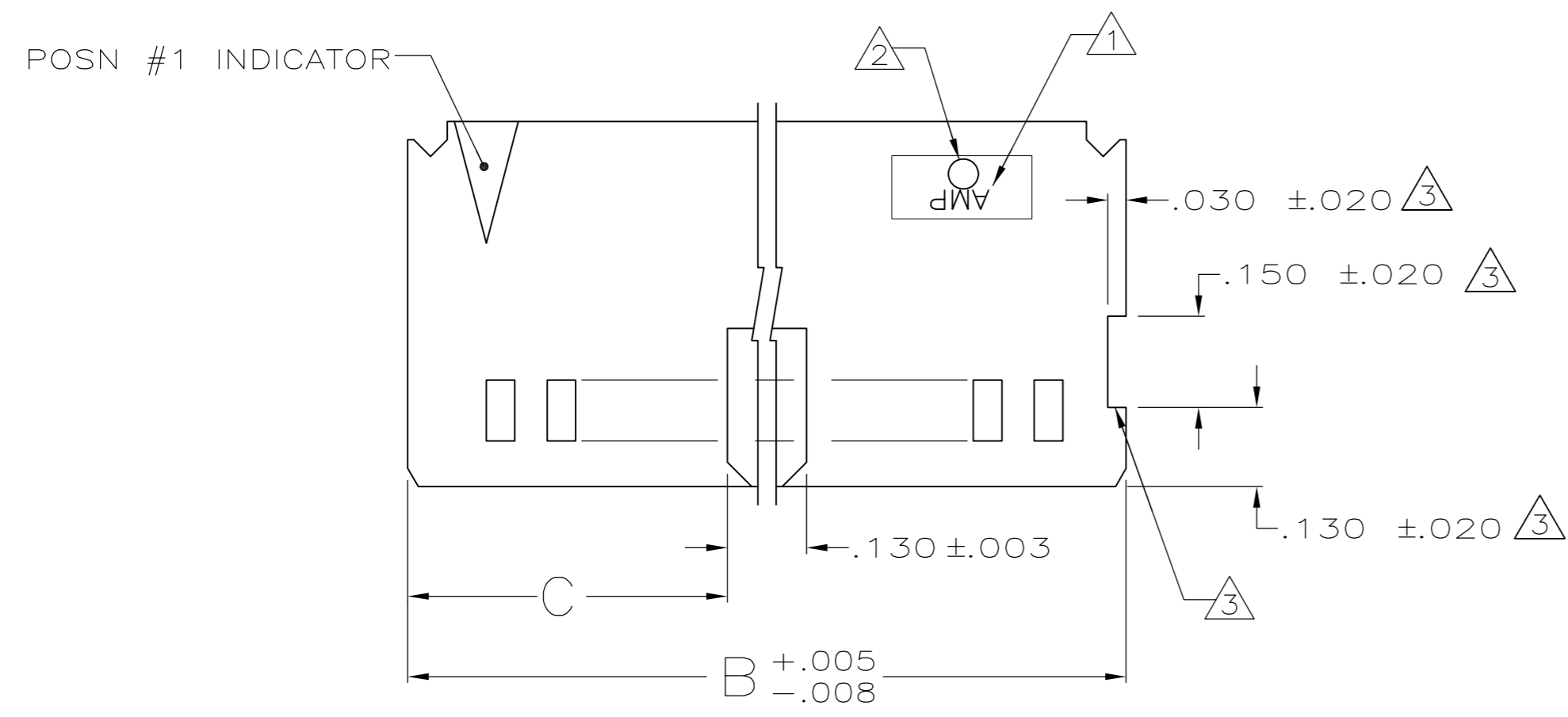

- 1 AMP TRADEMARK (MOLDED IN) .062±015 HIGH CHARACTERS LOCATED APPROX AS SHOWN
- 2 MOLD CAVITY IDENT (MOLDED IN) .046±015 HIGH CHARACTERS LOCATED APPROX AS SHOWN
- 3 RECESSED AREA AROUND MOLD GATE IS OPTIONAL. THIS FEATURE IS ALLOWABLE ON EITHER SIDE OF HOUSING OR MAY NOT BE PRESENT AT ALL.
- 4 COORDINATE DIMENSION APPLIES FROM CENTER OF FIRST ACTUAL FEATURE
- 5 RECESSED AREA AROUND GATE PERMISSIBLE. THIS FEATURE IS ALONG CENTERLINE OF MATING FACE.
- 6. WHEN MATING WITH AMP-LATCH UNIVERSAL HEADERS, P/N 1825851-1 MUST BE USED. PURCHASE SEPARATELY WITH HEADER- 2 REQUIRED.
- 7 OBSOLETE PARTS: OBSOLETE CIS STREAMLINING PER D.RENAUD/D.SINISI
- 8 VOID CORING IS OPTIONAL, AT MOLDER'S DISCRETION.

SIZE	CAGE CODE	DRAWING NO	RESTRICTED TO
A2	00779	C=102387	-

OBsolete	C	B	A	NO. OF POSN	PART NO.
7	.575	1.280	10	22	4-102387-5
	.225	.580	3	8	1-102387-4
	1.125	2.380	21	44	1-102387-3
	1.625	3.380	31	64	1-102387-2
	1.525	3.180	29	60	1-102387-1
	1.275	2.680	24	50	1-102387-0
	1.025	2.180	19	40	102387-9
	.875	1.880	16	34	102387-8
	.775	1.680	14	30	102387-7
	.675	1.480	12	26	102387-6
	.625	1.380	11	24	102387-5
	.525	1.180	9	20	102387-4
	.425	.980	7	16	102387-3
	.375	.880	6	14	102387-2
	.275	.680	4	10	102387-1

THIS DRAWING IS A CONTROLLED DOCUMENT.

DWN B MOYER 5-17-89
 CHK K. HELM 6-13-89

TE Connectivity

HOUSING, CRIMP SNAP-IN, SHORT ENTRY, MOD IV

MATERIAL: FLAME RETARDANT THERMOPLASTIC, COLOR: BLACK PER ASTM D4066
 FINISH: -

WEIGHT: -

CUSTOMER DRAWING

SCALE: 4:1 SHEET: 1 of 1 REV: S2

Mouser Electronics

Authorized Distributor

Click to View Pricing, Inventory, Delivery & Lifecycle Information:

[TE Connectivity:](#)

[102387-4](#)