

FEATURES

Small 20-lead QSOP

1000 V rms isolation rating

Safety and regulatory approvals (pending):

UL recognition (pending)

1000 V rms for 1 minute per UL 1577

Low power operation

3.3 V operation

1.6 mA per channel maximum at 0 Mbps to 1 Mbps

7.8 mA per channel maximum at 25 Mbps

5 V operation

2.2 mA per channel maximum at 0 Mbps to 1 Mbps

11.2 mA per channel maximum at 25 Mbps

Bidirectional communication

Up to 25 Mbps data rate (NRZ)

3 V/5 V level translation

High temperature operation: 105°C

High common-mode transient immunity: >15 kV/μs

APPLICATIONS

General-purpose, multichannel isolation

SPI interface/data converter isolation

RS-232/RS-422/RS-485 transceivers

Industrial field bus isolation

GENERAL DESCRIPTION

The ADuM7640/ADuM7641/ADuM7642/ADuM7643¹ are 6-channel digital isolators based on the Analog Devices, Inc., iCoupler® technology. These 1 kV digital isolation devices are packaged in a small 20-lead QSOP. They offer space savings and a lower price than 2.5 kV or 5 kV isolation solutions when only functional isolation is needed.

This family, like many Analog Devices isolators, offers very low power consumption, using one-tenth to one-sixth the power of other digital isolators, with the supply voltage on either side ranging from 3.0 V to 5.5 V. Despite their low power consumption, the ADuM7640/ADuM7641/ADuM7642/ADuM7643 provide low pulse width distortion (< 6 ns for C grade) and a channel-by-channel glitch filter to protect the device against extraneous noise disturbances. Four channel direction combinations are available with a maximum data rate of 1 Mbps or 25 Mbps. All products have a default output high logic state in the absence of input power.

¹ Protected by U.S. Patents 5,952,849; 6,873,065; and 7,075,329. Other patents pending.

Rev. 0

[Document Feedback](#)

Information furnished by Analog Devices is believed to be accurate and reliable. However, no responsibility is assumed by Analog Devices for its use, nor for any infringements of patents or other rights of third parties that may result from its use. Specifications subject to change without notice. No license is granted by implication or otherwise under any patent or patent rights of Analog Devices. Trademarks and registered trademarks are the property of their respective owners.

FUNCTIONAL BLOCK DIAGRAMS



Figure 1. ADuM7640

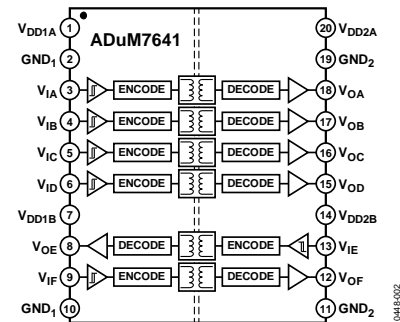

Figure 2. ADuM7641



Figure 3. ADuM7642



Figure 4. ADuM7643

TABLE OF CONTENTS

Features	1	Absolute Maximum Ratings	10
Applications.....	1	ESD Caution.....	10
General Description	1	Pin Configurations and Function Descriptions	11
Functional Block Diagrams.....	1	Typical Performance Characteristics	15
Revision History	2	Applications Information	17
Specifications.....	3	Printed Circuit Board Layout	17
Electrical Characteristics—5 V Operation.....	3	Propagation Delay-Related Parameters.....	17
Electrical Characteristics—3.3 V Operation	5	DC Correctness	17
Electrical Characteristics—Mixed 5 V/3.3 V Operation	7	Magnetic Field Immunity.....	18
Electrical Characteristics—Mixed 3.3 V/5 V Operation	8	Power Consumption	19
Package Characteristics	9	Insulation Lifetime	19
Regulatory Information.....	9	Outline Dimensions	20
Insulation and Safety Related Specifications	9	Ordering Guide	20
Recommended Operating Conditions	9		

REVISION HISTORY

9/12—Revision 0: Initial Version

SPECIFICATIONS

ELECTRICAL CHARACTERISTICS—5 V OPERATION

All typical specifications are at $T_A = 25^\circ\text{C}$, $V_{DD1} = V_{DD2} = 5\text{ V}$. Minimum/maximum specifications apply over the entire recommended operation range of $4.5\text{ V} \leq V_{DD1} \leq 5.5\text{ V}$, $4.5\text{ V} \leq V_{DD2} \leq 5.5\text{ V}$, and $-40^\circ\text{C} \leq T_A \leq +105^\circ\text{C}$, unless otherwise noted. Switching specifications are tested with $C_L = 15\text{ pF}$ and CMOS signal levels, unless otherwise noted.

Table 1.

Parameter	Symbol	A Grade			C Grade			Unit	Test Conditions/Comments
		Min	Typ	Max	Min	Typ	Max		
SWITCHING SPECIFICATIONS									
Pulse Width	PW	250			40			ns	Within PWD limit
Data Rate			1			25		Mbps	Within PWD limit
Propagation Delay	t_{PHL} , t_{PLH}		75		28	40	50	ns	50% input to 50% output
Pulse Width Distortion	PWD		25			2	6	ns	$ t_{PLH} - t_{PHL} $
Change vs. Temperature			5			3		ps/ $^\circ\text{C}$	
Propagation Delay Skew ¹	t_{PSK}		20				14	ns	
Channel Matching									
Codirectional ²	t_{PSKCD}		25			6	12	ns	
Opposing Directional ³	t_{PSKOD}		30			7	12	ns	
Jitter			2			2		ns	

¹ t_{PSK} is the magnitude of the worst-case difference in t_{PHL} or t_{PLH} that is measured between units at the same operating temperature, supply voltages, and output load within the recommended operating conditions.

² Codirectional channel matching is the absolute value of the difference in propagation delays between any two channels with inputs on the same side of the isolation barrier.

³ Opposing directional channel matching is the absolute value of the difference in propagation delays between any two channels with inputs on opposite sides of the isolation barrier.

Table 2.

Parameter	Symbol	1 Mbps—A and C Grades			25 Mbps—C Grade			Unit	Test Conditions/Comments
		Min	Typ	Max	Min	Typ	Max		
SUPPLY CURRENT									
ADuM7640	I_{DD1}		5.7	7.0		44	54	mA	No load
	I_{DD2}		4.4	5.9		11	13	mA	
ADuM7641	I_{DD1}		5.5	6.8		38	46	mA	
	I_{DD2}		4.6	5.7		15	19	mA	
ADuM7642	I_{DD1}		5.2	6.3		31	38	mA	
	I_{DD2}		4.8	6.0		19	24	mA	
ADuM7643	I_{DD1}		4.8	6.0		24	30	mA	
	I_{DD2}		5.0	6.3		22	29	mA	

Table 3.

Parameter	Symbol	Min	Typ	Max	Unit	Test Conditions/Comments
DC SPECIFICATIONS						
Input Voltage Threshold						
Logic High	V_{IH}	$0.7 V_{DDx}$			V	
Logic Low	V_{IL}			$0.3 V_{DDx}$	V	
Output Voltages						
Logic High	V_{OH}	$V_{DDx} - 0.1$	5.0		V	$I_{Ox} = -20 \mu A, V_{Ix} = V_{IxH}$
Logic Low	V_{OL}	$V_{DDx} - 0.4$	4.8		V	$I_{Ox} = -4 \text{ mA}, V_{Ix} = V_{IxH}$
Logic Low			0.0	0.1	V	$I_{Ox} = 20 \mu A, V_{Ix} = V_{IxL}$
Logic Low			0.2	0.4	V	$I_{Ox} = 4 \text{ mA}, V_{Ix} = V_{IxL}$
Input Current per Channel	I_I	-10	+0.01	+10	μA	$0 V \leq V_{Ix} \leq V_{DDx}$
Supply Current per Channel						
Quiescent Supply Current						
Input	$I_{DDI(Q)}$		0.95	1.16	mA	
Output	$I_{DDO(Q)}$		0.73	0.98	mA	
Dynamic Supply Current						
Input	$I_{DDI(D)}$		0.26		mA/Mbps	
Output	$I_{DDO(D)}$		0.04		mA/Mbps	
AC SPECIFICATIONS						
Output Rise/Fall Time	t_R/t_F		2.0		ns	10% to 90%
Common-Mode Transient Immunity ¹	$ CM $	15	25		kV/ μs	$V_{Ix} = V_{DDx}, V_{CM} = 1000 \text{ V}$, transient magnitude = 800 V
Refresh Rate	f_r		600		kHz	DC data inputs

¹ $|CM|$ is the maximum common-mode voltage slew rate that can be sustained while maintaining $V_{OL} < 0.8 \times V_{DDLx}$ or $V_{OH} > 0.7 \times V_{DDIx}$. The common-mode voltage slew rates apply to both rising and falling common-mode voltage edges.

ELECTRICAL CHARACTERISTICS—3.3 V OPERATION

All typical specifications are at $T_A = 25^\circ\text{C}$, $V_{DD1} = V_{DD2} = 3.3\text{ V}$. Minimum/maximum specifications apply over the entire recommended operation range of $3.0\text{ V} \leq V_{DD1} \leq 3.6\text{ V}$, $3.0\text{ V} \leq V_{DD2} \leq 3.6\text{ V}$, and $-40^\circ\text{C} \leq T_A \leq +105^\circ\text{C}$, unless otherwise noted. Switching specifications are tested with $C_L = 15\text{ pF}$ and CMOS signal levels, unless otherwise noted.

Table 4.

Parameter	Symbol	A Grade			C Grade			Unit	Test Conditions/Comments
		Min	Typ	Max	Min	Typ	Max		
SWITCHING SPECIFICATIONS									
Pulse Width	PW	250			40			ns	Within PWD limit
Data Rate				1			25	Mbps	Within PWD limit
Propagation Delay	t_{PHL} , t_{PLH}			85	33	49	66	ns	50% input to 50% output
Pulse Width Distortion	PWD			25		2	6	ns	$ t_{PLH} - t_{PHL} $
Change vs. Temperature			5			3		ps/ $^\circ\text{C}$	
Propagation Delay Skew ¹	t_{PSK}			20			14	ns	
Channel Matching									
Codirectional ²	t_{PSKCD}			25		6	12	ns	
Opposing Directional ³	t_{PSKOD}			30		6	15	ns	
Jitter				2		2		ns	

¹ t_{PSK} is the magnitude of the worst-case difference in t_{PHL} or t_{PLH} that is measured between units at the same operating temperature, supply voltages, and output load within the recommended operating conditions.

² Codirectional channel matching is the absolute value of the difference in propagation delays between any two channels with inputs on the same side of the isolation barrier.

³ Opposing directional channel matching is the absolute value of the difference in propagation delays between any two channels with inputs on opposite sides of the isolation barrier.

Table 5.

Parameter	Symbol	1 Mbps—A and C Grades			25 Mbps—C Grade			Unit	Test Conditions/Comments
		Min	Typ	Max	Min	Typ	Max		
SUPPLY CURRENT									
ADuM7640	I_{DD1}		4.1	5.2		32	38	mA	No load
	I_{DD2}		3.3	4.3		7.2	8.7	mA	
ADuM7641	I_{DD1}		3.9	4.9		27	33	mA	
	I_{DD2}		3.4	4.2		11	13	mA	
ADuM7642	I_{DD1}		3.7	4.7		23	27	mA	
	I_{DD2}		3.5	4.4		14	16	mA	
ADuM7643	I_{DD1}		3.5	4.4		18	21	mA	
	I_{DD2}		3.6	4.5		16	20	mA	

Table 6.

Parameter	Symbol	Min	Typ	Max	Unit	Test Conditions/Comments
DC SPECIFICATIONS						
Input Voltage Threshold						
Logic High	V_{IH}	$0.7 V_{DDx}$			V	
Logic Low	V_{IL}			$0.3 V_{DDx}$	V	
Output Voltages						
Logic High	V_{OH}	$V_{DDx} - 0.2$	3.3		V	$I_{Ox} = -20 \mu A, V_{Ix} = V_{IxH}$
		$V_{DDx} - 0.5$	3.1		V	$I_{Ox} = -4 mA, V_{Ix} = V_{IxH}$
Logic Low	V_{OL}		0.0	0.1	V	$I_{Ox} = 20 \mu A, V_{Ix} = V_{IxL}$
			0.2	0.4	V	$I_{Ox} = 4 mA, V_{Ix} = V_{IxL}$
Input Current per Channel	I_I	-10	+0.01	+10	μA	$0 V \leq V_{Ix} \leq V_{DDx}$
Supply Current per Channel						
Quiescent Supply Current						
Input	$I_{DDI(Q)}$		0.68	0.87	mA	
Output	$I_{DDO(Q)}$		0.55	0.72	mA	
Dynamic Supply Current						
Input	$I_{DDI(D)}$		0.19		mA/Mbps	
Output	$I_{DDO(D)}$		0.03		mA/Mbps	
AC SPECIFICATIONS						
Output Rise/Fall Time	t_R/t_F		2.8		ns	10% to 90%
Common-Mode Transient Immunity ¹	$ CM $	15	20		kV/ μs	$V_{Ix} = V_{DDx}, V_{CM} = 1000 V,$ transient magnitude = 800 V
Refresh Rate	f_r		550		kHz	DC data inputs

¹ $|CM|$ is the maximum common-mode voltage slew rate that can be sustained while maintaining $V_{OL} < 0.8 V_{DDLx}$ or $V_{OH} > 0.7 \times V_{DDIx}$. The common-mode voltage slew rates apply to both rising and falling common-mode voltage edges.

ELECTRICAL CHARACTERISTICS—MIXED 5 V/3.3 V OPERATION

All typical specifications are at $T_A = 25^\circ\text{C}$, $V_{DD1} = 5\text{ V}$, $V_{DD2} = 3.3\text{ V}$. Minimum/maximum specifications apply over the entire recommended operation range of $4.5\text{ V} \leq V_{DD1} \leq 5.5\text{ V}$, $3.0\text{ V} \leq V_{DD2} \leq 3.6\text{ V}$, and $-40^\circ\text{C} \leq T_A \leq +105^\circ\text{C}$, unless otherwise noted. Switching specifications are tested with $C_L = 15\text{ pF}$ and CMOS signal levels, unless otherwise noted.

Table 7.

Parameter	Symbol	A Grade			C Grade			Unit	Test Conditions/Comments
		Min	Typ	Max	Min	Typ	Max		
SWITCHING SPECIFICATIONS									
Pulse Width	PW	250			40			ns	Within PWD limit
Data Rate				1			25	Mbps	Within PWD limit
Propagation Delay	t_{PHL} , t_{PLH}			80	30	42	58	ns	50% input to 50% output
Pulse Width Distortion	PWD			25		2	6	ns	$ t_{PLH} - t_{PHL} $
Change vs. Temperature			5			3		ps/ $^\circ\text{C}$	
Propagation Delay Skew ¹	t_{PSK}			20			14	ns	
Channel Matching									
Codirectional ²	t_{PSKCD}			25		5	15	ns	
Opposing Directional ³	t_{PSKOD}			30		8	15	ns	
Jitter			2			2		ns	

¹ t_{PSK} is the magnitude of the worst-case difference in t_{PHL} or t_{PLH} that is measured between units at the same operating temperature, supply voltages, and output load within the recommended operating conditions.

² Codirectional channel matching is the absolute value of the difference in propagation delays between any two channels with inputs on the same side of the isolation barrier.

³ Opposing directional channel matching is the absolute value of the difference in propagation delays between any two channels with inputs on opposite sides of the isolation barrier.

Table 8.

Parameter	Symbol	1 Mbps—A, C Grades			25 Mbps—C Grade			Unit	Test Conditions/Comments
		Min	Typ	Max	Min	Typ	Max		
SUPPLY CURRENT									
ADuM7640	I_{DD1}		5.7	7.0		44	54	mA	No load
	I_{DD2}		3.3	4.1		7.5	8.7	mA	
ADuM7641	I_{DD1}		5.4	6.8		38	46	mA	
	I_{DD2}		3.4	4.0		11	13	mA	
ADuM7642	I_{DD1}		5.1	6.3		31	38	mA	
	I_{DD2}		3.5	4.3		14	16	mA	
ADuM7643	I_{DD1}		4.8	6.0		24	30	mA	
	I_{DD2}		3.6	4.3		16	20	mA	

Table 9.

Parameter	Symbol	Min	Typ	Max	Unit	Test Conditions/Comments
DC SPECIFICATIONS						
Input Voltage Threshold						
Logic High	V_{IH}	0.7 V_{DDX}			V	
Logic Low	V_{IL}				V	0.3 V_{DDX}
Output Voltages						
Logic High	V_{OH}	$V_{DDX} - 0.1$	V_{DDX}		V	$I_{OX} = -20\ \mu\text{A}$, $V_{IX} = V_{IXH}$
		$V_{DDX} - 0.5$	$V_{DDX} - 0.2$		V	$I_{OX} = -4\ \text{mA}$, $V_{IX} = V_{IXH}$
Logic Low	V_{OL}		0.0	0.1	V	$I_{OX} = 20\ \mu\text{A}$, $V_{IX} = V_{IXL}$
			0.2	0.4	V	$I_{OX} = 4\ \text{mA}$, $V_{IX} = V_{IXL}$
Input Current per Channel	I_i	-10	+0.01	+10	μA	$0\text{ V} \leq V_{IX} \leq V_{DDX}$
AC SPECIFICATIONS						
Output Rise/Fall Time	t_R/t_F		2.5		ns	10% to 90%
Common-Mode Transient Immunity ¹	$ CM $	15	20		kV/ μs	$V_{IX} = V_{DDX}$, $V_{CM} = 1000\text{ V}$, transient magnitude = 800 V
Refresh Rate	f_r		600		kHz	DC data inputs

¹ $|CM|$ is the maximum common-mode voltage slew rate that can be sustained while maintaining $V_{OL} < 0.8 V_{DDLX}$ or $V_{OH} > 0.7 \times V_{DDIX}$. The common-mode voltage slew rates apply to both rising and falling common-mode voltage edges.

ELECTRICAL CHARACTERISTICS—MIXED 3.3 V/5 V OPERATION

All typical specifications are at $T_A = 25^\circ\text{C}$, $V_{DD1} = 3.3\text{ V}$, $V_{DD2} = 5\text{ V}$. Minimum/maximum specifications apply over the entire recommended operation range of $3.0\text{ V} \leq V_{DD1} \leq 3.6\text{ V}$, $4.5\text{ V} \leq V_{DD2} \leq 5.5\text{ V}$, and $-40^\circ\text{C} \leq T_A \leq +105^\circ\text{C}$, unless otherwise noted. Switching specifications are tested with $C_L = 15\text{ pF}$ and CMOS signal levels, unless otherwise noted.

Table 10.

Parameter	Symbol	A Grade			C Grade			Unit	Test Conditions/Comments
		Min	Typ	Max	Min	Typ	Max		
SWITCHING SPECIFICATIONS									
Pulse Width	PW	250			40			ns	Within PWD limit
Data Rate				1			25	Mbps	Within PWD limit
Propagation Delay	t_{PHL} , t_{PLH}			80	29	46	60	ns	50% input to 50% output
Pulse Width Distortion	PWD			25		2	6	ns	$ t_{PLH} - t_{PHL} $
Change vs. Temperature			5			3		ps/ $^\circ\text{C}$	
Propagation Delay Skew ¹	t_{PSK}			20			14	ns	
Channel Matching									
Codirectional ²	t_{PSKCD}			25		6	13	ns	
Opposing Directional ³	t_{PSKOD}			30		9	18	ns	
Jitter			2			2		ns	

¹ t_{PSK} is the magnitude of the worst-case difference in t_{PHL} or t_{PLH} that is measured between units at the same operating temperature, supply voltages, and output load within the recommended operating conditions.

² Codirectional channel matching is the absolute value of the difference in propagation delays between any two channels with inputs on the same side of the isolation barrier.

³ Opposing directional channel matching is the absolute value of the difference in propagation delays between any two channels with inputs on opposite sides of the isolation barrier.

Table 11.

Parameter	Symbol	1 Mbps—A, C Grades			25 Mbps—C Grade			Unit	Test Conditions/Comments
		Min	Typ	Max	Min	Typ	Max		
SUPPLY CURRENT									
ADuM7640	I_{DD1}		4.1	4.9		32	38	mA	No load
	I_{DD2}		4.5	5.9		11	13	mA	
ADuM7641	I_{DD1}		3.9	4.7		27	33	mA	
	I_{DD2}		4.6	5.7		15	19	mA	
ADuM7642	I_{DD1}		3.7	4.4		23	27	mA	
	I_{DD2}		4.8	6.0		19	24	mA	
ADuM7643	I_{DD1}		3.5	4.2		18	21	mA	
	I_{DD2}		5.0	6.2		22	29	mA	

Table 12.

Parameter	Symbol	Min	Typ	Max	Unit	Test Conditions/Comments
DC SPECIFICATIONS						
Input Voltage Threshold						
Logic High	V_{IH}	$0.7 V_{DDx}$			V	
Logic Low	V_{IL}				V	$0.3 V_{DDx}$
Output Voltages						
Logic High	V_{OH}	$V_{DDx} - 0.1$	V_{DDx}		V	$I_{Ox} = -20\ \mu\text{A}$, $V_{Ix} = V_{IxH}$
		$V_{DDx} - 0.5$	$V_{DDx} - 0.2$		V	$I_{Ox} = -4\ \text{mA}$, $V_{Ix} = V_{IxH}$
Logic Low	V_{OL}		0.0	0.1	V	$I_{Ox} = 20\ \mu\text{A}$, $V_{Ix} = V_{IxL}$
			0.2	0.4	V	$I_{Ox} = 4\ \text{mA}$, $V_{Ix} = V_{IxL}$
Input Current per Channel	I_I	-10	+0.01	+10	μA	$0\text{ V} \leq V_{Ix} \leq V_{DDx}$
AC SPECIFICATIONS						
Output Rise/Fall Time	t_R/t_F		2.5		ns	10% to 90%
Common-Mode Transient Immunity ¹	$ CM $	15	20		kV/ μs	$V_{Ix} = V_{DDx}$, $V_{CM} = 1000\text{ V}$, transient magnitude = 800 V
Refresh Rate	f_r		550		kHz	DC data inputs

¹ $|CM|$ is the maximum common-mode voltage slew rate that can be sustained while maintaining $V_{OL} < 0.8 V_{DDLx}$ or $V_{OH} > 0.7 \times V_{DDLx}$. The common-mode voltage slew rates apply to both rising and falling common-mode voltage edges.

PACKAGE CHARACTERISTICS

Table 13.

Parameter	Symbol	Min	Typ	Max	Unit	Test Conditions/Comments
Resistance (Input to Output) ¹	R _{I-O}		10 ¹³		Ω	
Capacitance (Input to Output) ¹	C _{I-O}		2		pF	f = 1 MHz
Input Capacitance ²	C _I		4.0		pF	
IC Junction-to-Ambient Thermal Resistance	θ _{JA}		76		°C/W	Thermocouple located at center of package underside

¹ The device is considered a 2-terminal device: Pin 1 through Pin 10 are shorted together, and Pin 11 through Pin 20 are shorted together.

² Input capacitance is from any input data pin to ground.

REGULATORY INFORMATION

The ADuM7640/ADuM7641/ADuM7642/ADuM7643 are approved by the organizations listed in Table 14. See Table 18 and the Insulation Lifetime section for recommended maximum working voltages for specific cross-isolation waveforms and insulation levels.

Table 14.

UL (Pending)

Recognized Under UL 1577 Component Recognition Program¹
 Single Protection, 1000 V rms Isolation Voltage
 File E274400

¹ In accordance with UL 1577, each ADuM7640/ADuM7641/ADuM7642/ADuM7643 is proof tested by applying an insulation test voltage ≥ 1200 V rms for 1 sec (current leakage detection limit = 5 μA).

INSULATION AND SAFETY RELATED SPECIFICATIONS

Table 15.

Parameter	Symbol	Value	Unit	Test Conditions/Comments
Rated Dielectric Insulation Voltage		1000	V rms	1 minute duration
Minimum External Air Gap (Clearance)	L(I01)	3.8	mm min	Measured from input terminals to output terminals, shortest distance through air
Minimum External Tracking (Creepage)	L(I02)	2.8	mm min	Measured from input terminals to output terminals, shortest distance path along body
Minimum Internal Gap (Internal Clearance)		2.6	μm min	Insulation distance through insulation
Tracking Resistance (Comparative Tracking Index)	CTI	>400	V	DIN IEC 112/VDE 0303 Part 1
Isolation Group		II		Material Group (DIN VDE 0110, 1/89, Table 1)

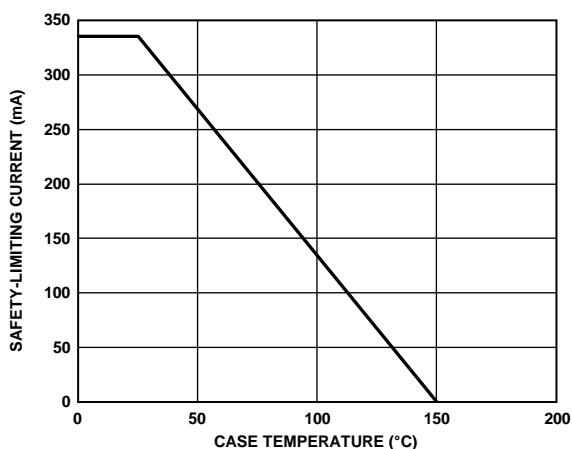

Figure 5. Thermal Derating Curve, Dependence of Safety-Limiting Values on Case Temperature per DIN V VDE V 0884-10

RECOMMENDED OPERATING CONDITIONS

Table 16.

Parameter	Symbol	Min	Max	Unit
Operating Temperature	T _A	-40	+105	°C
Supply Voltages ¹	V _{DD1} , V _{DD2}	3.0	5.5	V
Input Signal Rise and Fall Times			1.0	ms

¹ All voltages are relative to their respective grounds. See the DC Correctness section for information about immunity to external magnetic fields.

ABSOLUTE MAXIMUM RATINGS

$T_A = 25^\circ\text{C}$, unless otherwise noted.

Table 17.

Parameter	Rating
Storage Temperature (T_{ST}) Range	-65°C to $+150^\circ\text{C}$
Ambient Operating Temperature (T_A)	-40°C to $+105^\circ\text{C}$
Supply Voltages (V_{DD1} , V_{DD2})	-0.5 V to $+7.0\text{ V}$
Input Voltages (V_{IA} , V_{IB} , V_{IC} , V_{ID} , V_{IE} , V_{IF}) ^{1,2}	-0.5 V to $V_{DD1} + 0.5\text{ V}$
Output Voltages (V_{OA} , V_{OB} , V_{OC} , V_{OD} , V_{OE} , V_{OF}) ^{1,2}	-0.5 V to $V_{DD0} + 0.5\text{ V}$
Average Output Current per Pin ³	
Side 1 (I_{O1})	-10 mA to $+10\text{ mA}$
Side 2 (I_{O2})	-10 mA to $+10\text{ mA}$
Common-Mode Transients ³	$-100\text{ kV}/\mu\text{s}$ to $+100\text{ kV}/\mu\text{s}$

¹ V_{DD1} and V_{DD0} refer to the supply voltages on the input and output sides of a given channel, respectively. See the Printed Circuit Board Layout section.

² See Figure 5 for maximum rated current values for various temperatures.

³ Refers to common-mode transients across the insulation barrier. Common-mode transients exceeding the absolute maximum ratings may cause latch-up or permanent damage.

Table 18. Maximum Continuous Working Voltage¹

Parameter	Max	Unit	Constraint
AC Voltage, Bipolar Waveform	420	V peak	50-year minimum lifetime
AC Voltage, Unipolar Waveform			
Basic Insulation	420	V peak	50-year minimum lifetime
DC Voltage			
Basic Insulation	420	V peak	50-year minimum lifetime

¹ Refers to continuous voltage magnitude imposed across the isolation barrier. See the Insulation Lifetime section for more information.

Table 19. Truth Table (Positive Logic)

V_{IX} Input ¹	V_{DD1} State ²	V_{DD0} State ³	V_{OX} Output ¹	Description
H	Powered	Powered	H	Normal operation; data is high.
L	Powered	Powered	L	Normal operation; data is low.
X	Unpowered	Powered	H	Input unpowered. Output pins are in the default high state. Outputs return to input state within $1.6\ \mu\text{s}$ of V_{DD1} power restoration. See the pin function descriptions (Table 20 through Table 23) for more information.
X	Powered	Unpowered	Z	Output unpowered. Output pins are in high impedance state. Outputs return to input state within $1.6\ \mu\text{s}$ of V_{DD0} power restoration. See the pin function descriptions (Table 20 through Table 23) for more information.

¹ V_{IX} and V_{OX} refer to the input and output signals of a given channel (A, B, C, D, E or F).

² V_{DD1} refers to the supply voltage on the input side of a given channel (A, B, C, D, E or F).

³ V_{DD0} refers to the supply voltage on the output side of a given channel (A, B, C, D, E or F).

Stresses above those listed under Absolute Maximum Ratings may cause permanent damage to the device. This is a stress rating only; functional operation of the device at these or any other conditions above those indicated in the operational section of this specification is not implied. Exposure to absolute maximum rating conditions for extended periods may affect device reliability.

ESD CAUTION



ESD (electrostatic discharge) sensitive device.

Charged devices and circuit boards can discharge without detection. Although this product features patented or proprietary protection circuitry, damage may occur on devices subjected to high energy ESD. Therefore, proper ESD precautions should be taken to avoid performance degradation or loss of functionality.

PIN CONFIGURATIONS AND FUNCTION DESCRIPTIONS



* PIN 2 AND PIN 10 ARE INTERNALLY CONNECTED. CONNECTING BOTH PINS TO PCB SIDE 1 GROUND IS RECOMMENDED. PIN 11 AND PIN 19 ARE INTERNALLY CONNECTED. CONNECTING BOTH PINS TO PCB SIDE 2 GROUND IS RECOMMENDED.

10-448-006

Figure 6. ADuM7640 Pin Configuration

Table 20. ADuM7640 Pin Function Descriptions

Pin No.	Mnemonic	Description
1	V _{DD1A}	Supply Voltage A for Isolator Side 1 (3.0 V to 5.5 V). Pin 1 must be connected externally to Pin 7. Connect a 0.01 μ F to 0.1 μ F between V _{DD1A} (Pin 1) and GND ₁ (Pin 2).
2	GND ₁	Ground Reference for Isolator Side 1. Pin 2 and Pin 10 are internally connected, and connecting both pins to the PCB ground plane is recommended.
3	V _{IA}	Logic Input A.
4	V _{IB}	Logic Input B.
5	V _{IC}	Logic Input C.
6	V _{ID}	Logic Input D.
7	V _{DD1B}	Supply Voltage B for Isolator Side 1 (3.0 V to 5.5 V). Pin 7 must be connected externally to Pin 1. Connect a 0.01 μ F to 0.1 μ F between V _{DD1B} (Pin 7) and GND ₁ (Pin 10).
8	V _{IE}	Logic Input E.
9	V _{IF}	Logic Input F.
10	GND ₁	Ground Reference for Isolator Side 1. Pin 2 and Pin 10 are internally connected, and connecting both pins to the PCB ground plane is recommended.
11	GND ₂	Ground Reference for Isolator Side 2. Pin 11 and Pin 19 are internally connected, and connecting both pins to the PCB ground plane is recommended.
12	V _{OF}	Logic Output F.
13	V _{OE}	Logic Output E.
14	V _{DD2B}	Supply Voltage B for Isolator Side 2 (3.0 V to 5.5 V). Pin 14 must be connected externally to Pin 20. Connect a 0.01 μ F to 0.1 μ F between V _{DD2B} (Pin 14) and GND ₂ (Pin 11).
15	V _{OD}	Logic Output D.
16	V _{OC}	Logic Output C.
17	V _{OB}	Logic Output B.
18	V _{OA}	Logic Output A.
19	GND ₂	Ground Reference for Isolator Side 2. Pin 11 and Pin 19 are internally connected, and connecting both pins to the PCB ground plane is recommended.
20	V _{DD2A}	Supply Voltage A for Isolator Side 2 (3.0 V to 5.5 V). Pin 20 must be connected externally to Pin 14. Connect a 0.01 μ F to 0.1 μ F between V _{DD2A} (Pin 20) and GND ₂ (Pin 19).

Reference the [AN-1109 Application Note](#) for specific layout guidelines.

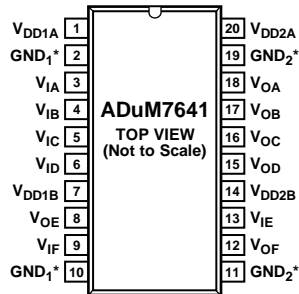

*PIN 2 AND PIN 10 ARE INTERNALLY CONNECTED. CONNECTING BOTH PINS TO PCB SIDE 1 GROUND IS RECOMMENDED. PIN 11 AND PIN 19 ARE INTERNALLY CONNECTED. CONNECTING BOTH PINS TO PCB SIDE 2 GROUND IS RECOMMENDED.

10448-007

Figure 7. ADuM7641 Pin Configuration

Table 21. ADuM7641 Pin Function Descriptions

Pin No.	Mnemonic	Description
1	V _{DD1A}	Supply Voltage A for Isolator Side 1 (3.0 V to 5.5 V). Pin 1 must be connected externally to Pin 7. Connect a 0.01 μ F to 0.1 μ F between V _{DD1A} (Pin 1) and GND ₁ (Pin 2).
2	GND ₁	Ground Reference for Isolator Side 1. Pin 2 and Pin 10 are internally connected, and connecting both pins to the PCB ground plane is recommended.
3	V _{IA}	Logic Input A.
4	V _{IB}	Logic Input B.
5	V _{IC}	Logic Input C.
6	V _{ID}	Logic Input D.
7	V _{DD1B}	Supply Voltage B for Isolator Side 1 (3.0 V to 5.5 V). Pin 7 must be connected externally to Pin 1. Connect a 0.01 μ F to 0.1 μ F between V _{DD1B} (Pin 7) and GND ₁ (Pin 10).
8	V _{OE}	Logic Output E.
9	V _{IF}	Logic Input F.
10	GND ₁	Ground Reference for Isolator Side 1. Pin 2 and Pin 10 are internally connected, and connecting both pins to the PCB ground plane is recommended.
11	GND ₂	Ground Reference for Isolator Side 2. Pin 11 and Pin 19 are internally connected, and connecting both pins to the PCB ground plane is recommended.
12	V _{OF}	Logic Output F.
13	V _{IE}	Logic Input E.
14	V _{DD2B}	Supply Voltage B for Isolator Side 2 (3.0 V to 5.5 V). Pin 14 must be connected externally to Pin 20. Connect a 0.01 μ F to 0.1 μ F between V _{DD2B} (Pin 14) and GND ₂ (Pin 11).
15	V _{OD}	Logic Output D.
16	V _{OC}	Logic Output C.
17	V _{OB}	Logic Output B.
18	V _{OA}	Logic Output A.
19	GND ₂	Ground Reference for Isolator Side 2. Pin 11 and Pin 19 are internally connected, and connecting both pins to the PCB ground plane is recommended.
20	V _{DD2A}	Supply Voltage A for Isolator Side 2 (3.0 V to 5.5 V). Pin 20 must be connected externally to Pin 14. Connect a 0.01 μ F to 0.1 μ F between V _{DD2A} (Pin 20) and GND ₂ (Pin 19).

Reference the [AN-1109 Application Note](#) for specific layout guidelines.



*PIN 2 AND PIN 10 ARE INTERNALLY CONNECTED. CONNECTING BOTH PINS TO PCB SIDE 1 GROUND IS RECOMMENDED. PIN 11 AND PIN 19 ARE INTERNALLY CONNECTED. CONNECTING BOTH PINS TO PCB SIDE 2 GROUND IS RECOMMENDED.

10-448-008

Figure 8. ADuM7642 Pin Configuration

Table 22. ADuM7642 Pin Function Descriptions

Pin No.	Mnemonic	Description
1	V _{DD1A}	Supply Voltage A for Isolator Side 1 (3.0 V to 5.5 V). Pin 1 must be connected externally to Pin 7. Connect a 0.01 μ F to 0.1 μ F between V _{DD1A} (Pin 1) and GND ₁ (Pin 2).
2	GND ₁	Ground Reference for Isolator Side 1. Pin 2 and Pin 10 are internally connected, and connecting both pins to the PCB ground plane is recommended.
3	V _{IA}	Logic Input A.
4	V _{IB}	Logic Input B.
5	V _{IC}	Logic Input C.
6	V _{OD}	Logic Output D.
7	V _{DD1B}	Supply Voltage B for Isolator Side 1 (3.0 V to 5.5 V). Pin 7 must be connected externally to Pin 1. Connect a 0.01 μ F to 0.1 μ F between V _{DD1B} (Pin 7) and GND ₁ (Pin 10).
8	V _{OE}	Logic Output E.
9	V _{IF}	Logic Input F.
10	GND ₁	Ground Reference for Isolator Side 1. Pin 2 and Pin 10 are internally connected, and connecting both pins to the PCB ground plane is recommended.
11	GND ₂	Ground Reference for Isolator Side 2. Pin 11 and Pin 19 are internally connected, and connecting both pins to the PCB ground plane is recommended.
12	V _{OF}	Logic Output F.
13	V _{IE}	Logic Input E.
14	V _{DD2B}	Supply Voltage B for Isolator Side 2 (3.0 V to 5.5 V). Pin 14 must be connected externally to Pin 20. Connect a 0.01 μ F to 0.1 μ F between V _{DD2B} (Pin 14) and GND ₂ (Pin 11).
15	V _{ID}	Logic Input D.
16	V _{OC}	Logic Output C.
17	V _{OB}	Logic Output B.
18	V _{OA}	Logic Output A.
19	GND ₂	Ground Reference for Isolator Side 2. Pin 11 and Pin 19 are internally connected, and connecting both pins to the PCB ground plane is recommended.
20	V _{DD2A}	Supply Voltage A for Isolator Side 2 (3.0 V to 5.5 V). Pin 20 must be connected externally to Pin 14. Connect a 0.01 μ F to 0.1 μ F between V _{DD2A} (Pin 20) and GND ₂ (Pin 19).

Reference the [AN-1109 Application Note](#) for specific layout guidelines.



*PIN 2 AND PIN 10 ARE INTERNALLY CONNECTED. CONNECTING BOTH PINS TO PCB SIDE 1 GROUND IS RECOMMENDED. PIN 11 AND PIN 19 ARE INTERNALLY CONNECTED. CONNECTING BOTH PINS TO PCB SIDE 2 GROUND IS RECOMMENDED.

10448-009

Figure 9. ADuM7643 Pin Configuration

Table 23. ADuM7643 Pin Function Descriptions

Pin No.	Mnemonic	Description
1	V _{DD1A}	Supply Voltage A for Isolator Side 1 (3.0 V to 5.5 V). Pin 1 must be connected externally to Pin 7. Connect a 0.01 μF to 0.1 μF between V _{DD1A} (Pin 1) and GND ₁ (Pin 2).
2	GND ₁	Ground Reference for Isolator Side 1. Pin 2 and Pin 10 are internally connected, and connecting both pins to the PCB ground plane is recommended.
3	V _{1A}	Logic Input A.
4	V _{1B}	Logic Input B.
5	V _{1OC}	Logic Output C.
6	V _{1OD}	Logic Output D.
7	V _{DD1B}	Supply Voltage B for Isolator Side 1 (3.0 V to 5.5 V). Pin 7 must be connected externally to Pin 1. Connect a 0.01 μF to 0.1 μF between V _{DD1B} (Pin 7) and GND ₁ (Pin 10).
8	V _{1OE}	Logic Output E.
9	V _{1IF}	Logic Input F.
10	GND ₁	Ground Reference for Isolator Side 1. Pin 2 and Pin 10 are internally connected, and connecting both pins to the PCB ground plane is recommended.
11	GND ₂	Ground Reference for Isolator Side 2. Pin 11 and Pin 19 are internally connected, and connecting both pins to the PCB ground plane is recommended.
12	V _{1OF}	Logic Output F.
13	V _{1IE}	Logic Input E.
14	V _{DD2B}	Supply Voltage B for Isolator Side 2 (3.0 V to 5.5 V). Pin 14 must be connected externally to Pin 20. Connect a 0.01 μF to 0.1 μF between V _{DD2B} (Pin 14) and GND ₂ (Pin 11).
15	V _{1ID}	Logic Input D.
16	V _{1IC}	Logic Input C.
17	V _{1OB}	Logic Output B.
18	V _{1OA}	Logic Output A.
19	GND ₂	Ground Reference for Isolator Side 2. Pin 11 and Pin 19 are internally connected, and connecting both pins to the PCB ground plane is recommended.
20	V _{DD2A}	Supply Voltage A for Isolator Side 2 (3.0 V to 5.5 V). Pin 20 must be connected externally to Pin 14. Connect a 0.01 μF to 0.1 μF between V _{DD2A} (Pin 20) and GND ₂ (Pin 19).

Reference the [AN-1109 Application Note](#) for specific layout guidelines.

TYPICAL PERFORMANCE CHARACTERISTICS



Figure 10. Typical Supply Current per Input Channel vs. Data Rate for 5 V and 3.3 V Operation

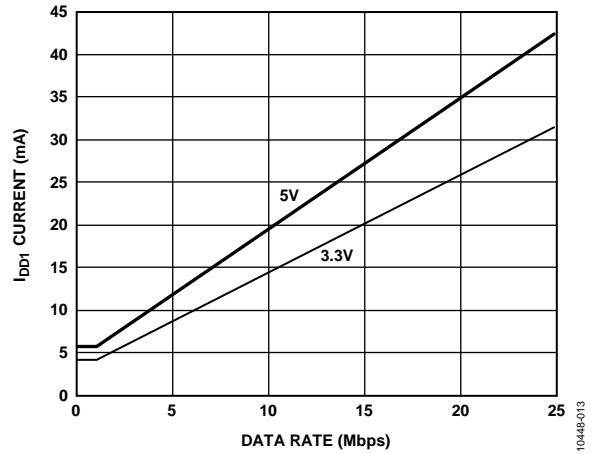

Figure 13. Typical ADuM7640 V_{DD1} Supply Current vs. Data Rate for 5 V and 3.3 V Operation



Figure 11. Typical Supply Current per Output Channel vs. Data Rate for 5 V and 3.3 V Operation (No Output Load)

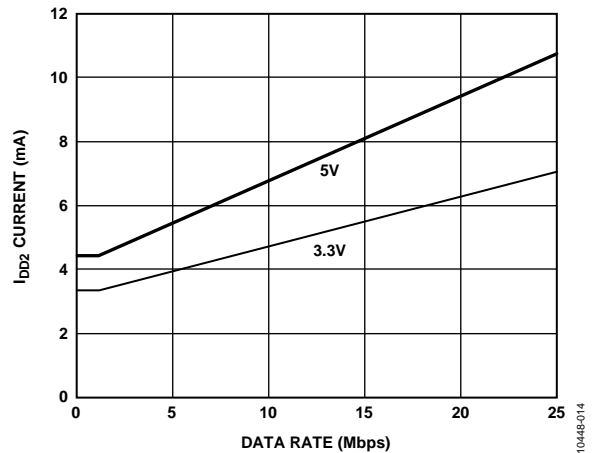

Figure 14. Typical ADuM7640 V_{DD2} Supply Current vs. Data Rate for 5 V and 3.3 V Operation



Figure 12. Typical Supply Current per Output Channel vs. Data Rate for 5 V and 3.3 V Operation (15 pF Output Load)

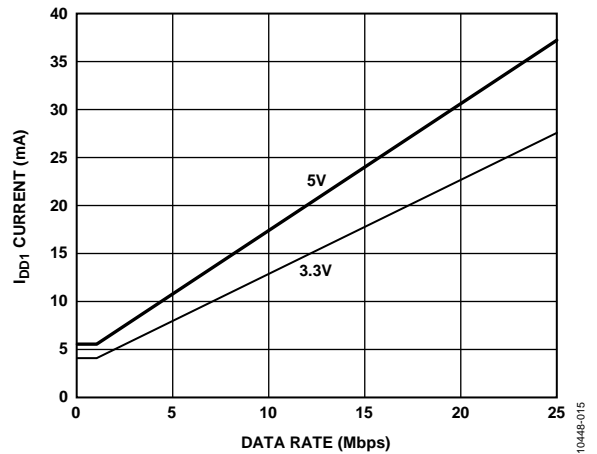

Figure 15. Typical ADuM7641 V_{DD1} Supply Current vs. Data Rate for 5 V and 3.3 V Operation



Figure 16. Typical ADuM7641 V_{DD2} Supply Current vs. Data Rate for 5 V and 3.3 V Operation

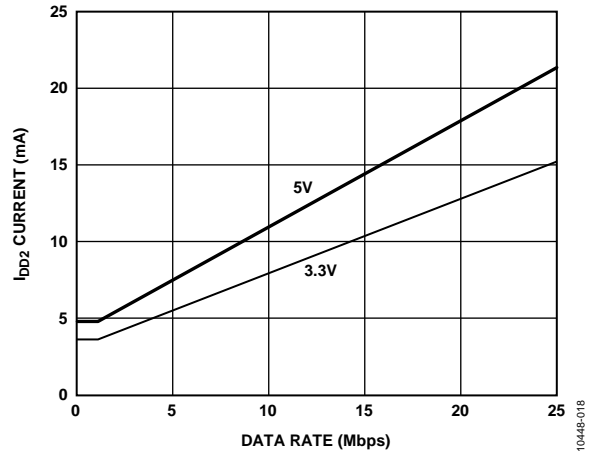

Figure 18. Typical ADuM7642 V_{DD2} Supply Current vs. Data Rate for 5 V and 3.3 V Operation



Figure 17. Typical ADuM7642 V_{DD1} Supply Current vs. Data Rate for 5 V and 3.3 V Operation

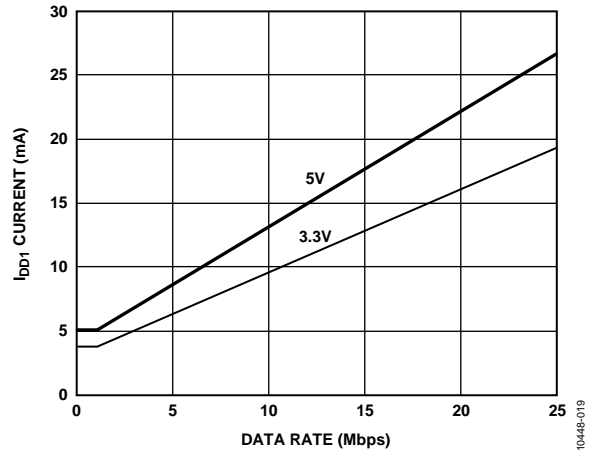

Figure 19. Typical ADuM7643 V_{DD1} or V_{DD2} Supply Current vs. Data Rate for 5 V and 3.3 V Operation

APPLICATIONS INFORMATION

PRINTED CIRCUIT BOARD LAYOUT

The [ADuM7640/ADuM7641/ADuM7642/ADuM7643](#) digital isolators require no external interface circuitry for the logic interfaces. Power supply bypassing is strongly recommended at the input and output supply pins (see Figure 20). Connect four bypass capacitors between Pin 1 and Pin 2 for V_{DD1A} , between Pin 7 and Pin 10 for V_{DD1B} , between Pin 11 and Pin 14 for V_{DD2B} , and between Pin 19 and Pin 20 for V_{DD2A} . Connect the V_{DD1A} supply pin and the V_{DD1B} supply pin together, and connect the V_{DD2B} supply pin and V_{DD2A} supply pin together. The capacitor values should be from 0.01 μF to 0.1 μF . The total lead length between both ends of the capacitor and the power supply pin should not exceed 20 mm.



Figure 20. Recommended Printed Circuit Board Layout

In applications involving high common-mode transients, it is important to minimize board coupling across the isolation barrier. Furthermore, users should design the board layout so that any coupling that occurs affects all pins equally on a given component side. Failure to follow this design guideline can cause voltage differentials between pins that exceed the absolute maximum ratings of the device, which can lead to latch-up or permanent damage.

With proper PCB design choices, the [ADuM7640/ADuM7641/ADuM7642/ADuM7643](#) can readily meet CISPR 22 Class A (and FCC Class A) emissions standards, as well as the more stringent CISPR 22 Class B (and FCC Class B) standards in an unshielded environment. For PCB-related EMI mitigation techniques, including board layout and stack-up issues, see the [AN-1109 Application Note](#).

PROPAGATION DELAY-RELATED PARAMETERS

Propagation delay is a parameter that describes the time it takes a logic signal to propagate through a component. The input-to-output propagation delay time for a high-to-low transition may differ from the propagation delay time for a low-to-high transition.

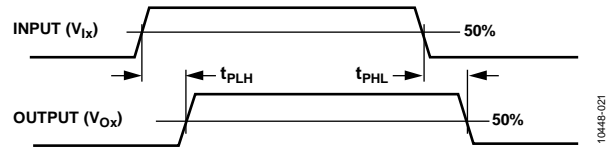

Figure 21. Propagation Delay Parameters

Pulse width distortion is the maximum difference between these two propagation delay values and is an indication of how accurately the timing of the input signal is preserved.

Channel-to-channel matching refers to the maximum amount of time that the propagation delay differs between channels within a single [ADuM7640/ADuM7641/ADuM7642/ADuM7643](#) component.

Propagation delay skew refers to the maximum amount of time that the propagation delay differs between multiple [ADuM7640/ADuM7641/ADuM7642/ADuM7643](#) components operating under the same conditions.

DC CORRECTNESS

Positive and negative logic transitions at the isolator input cause narrow (~ 1 ns) pulses to be sent to the decoder using the transformer. The decoder is bistable and is, therefore, either set or reset by the pulses, indicating input logic transitions. In the absence of logic transitions at the input for more than ~ 1 μs , a periodic set of refresh pulses indicative of the correct input state is sent to ensure dc correctness at the output. If the decoder receives no internal pulses for more than approximately 5 μs , the input side is assumed to be unpowered or nonfunctional, in which case the isolator output is forced to a default high state by the watchdog timer circuit.

MAGNETIC FIELD IMMUNITY

The magnetic field immunity of the ADuM7640/ADuM7641/ADuM7642/ADuM7643 is determined by the changing magnetic field, which induces a voltage in the transformer receiving coil large enough to either falsely set or reset the decoder. The following analysis defines the conditions under which this can occur. The 3 V operating condition of the ADuM7640/ADuM7641/ADuM7642/ADuM7643 is examined because it represents the most susceptible mode of operation.

The pulses at the transformer output have an amplitude greater than 1.0 V. The decoder has a sensing threshold at approximately 0.5 V, thus establishing a 0.5 V margin in which induced voltages can be tolerated. The voltage induced across the receiving coil is given by

$$V = (-d\beta/dt) \sum \pi r_n^2; n = 1, 2, \dots, N$$

where:

β is magnetic flux density (gauss).

r_n is the radius of the n^{th} turn in the receiving coil (cm).

N is the total number of turns in the receiving coil.

Given the geometry of the receiving coil in the ADuM7640/ADuM7641/ADuM7642/ADuM7643 and an imposed requirement that the induced voltage be, at most, 50% of the 0.5 V margin at the decoder, a maximum allowable magnetic field at a given frequency can be calculated. The result is shown in Figure 22.

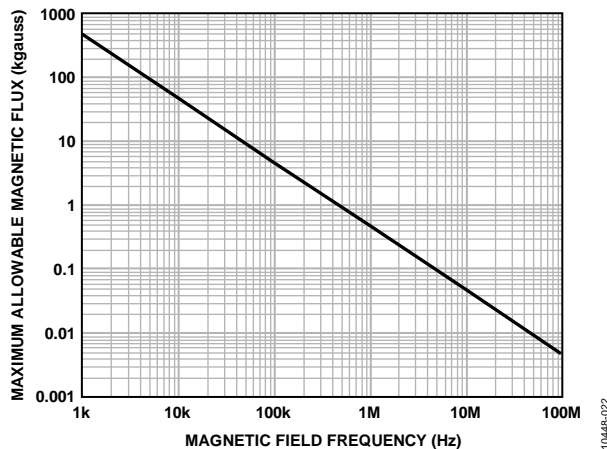

Figure 22. Maximum Allowable External Magnetic Flux Density

For example, at a magnetic field frequency of 1 MHz, the maximum allowable magnetic field of 0.5 kgauss induces a voltage of 0.25 V at the receiving coil. This voltage is approximately 50% of the sensing threshold and does not cause a faulty output transition. Similarly, if such an event occurs during a transmitted pulse and is of the worst-case polarity, it reduces the received pulse from >1.0 V to 0.75 V, still well above the 0.5 V sensing threshold of the decoder.

The preceding magnetic flux density values correspond to specific current magnitudes at given distances from the ADuM7640/ADuM7641/ADuM7642/ADuM7643 transformers. Figure 23 shows these allowable current magnitudes as a function of frequency for selected distances. As shown in Figure 23, the ADuM7640/ADuM7641/ADuM7642/ADuM7643 are extremely immune and can be affected only by extremely large currents operated at high frequency very close to the component. For the 1 MHz example noted previously, a 1.2 kA current would have to be placed 5 mm away from the ADuM7640/ADuM7641/ADuM7642/ADuM7643 to affect the operation of the component.



Figure 23. Maximum Allowable Current for Various Current-to-ADuM7640/ADuM7641/ADuM7642/ADuM7643 Spacings

Note that at combinations of strong magnetic field and high frequency, any loops formed by printed circuit board traces can induce error voltages sufficiently large to trigger the thresholds of succeeding circuitry. Take care in the layout of such traces to avoid this possibility.

POWER CONSUMPTION

The supply current at a given channel of the [ADuM7640/ADuM7641/ADuM7642/ADuM7643](#) isolator is a function of the supply voltage, the data rate of the channel, and the output load of the channel.

For each input channel, the supply current is given by

$$I_{DDI} = I_{DDI(Q)} \quad f \leq 0.5 f_r$$

$$I_{DDI} = I_{DDI(D)} \times (2f - f_r) + I_{DDI(Q)} \quad f > 0.5 f_r$$

For each output channel, the supply current is given by

$$I_{DDO} = I_{DDO(Q)} \quad f \leq 0.5 f_r$$

$$I_{DDO} = (I_{DDO(D)} + (0.5 \times 10^{-3}) \times C_L \times V_{DDO}) \times (2f - f_r) + I_{DDO(Q)} \quad f > 0.5 f_r$$

where:

$I_{DDI(D)}$, $I_{DDO(D)}$ are the input and output dynamic supply currents per channel (mA/Mbps).

$I_{DDI(Q)}$, $I_{DDO(Q)}$ are the specified input and output quiescent supply currents (mA).

f is the input logic signal frequency (MHz); it is half the input data rate, expressed in units of Mbps.

f_r is the input stage refresh rate (Mbps).

C_L is the output load capacitance (pF).

V_{DDO} is the output supply voltage (V).

To calculate the total V_{DD1} and V_{DD2} supply current, the supply currents for each input and output channel corresponding to V_{DD1} and V_{DD2} are calculated and totaled. Figure 10 and Figure 11 show per-channel supply currents as a function of data rate for an unloaded output condition. Figure 12 shows the per-channel supply current as a function of data rate for a 15 pF output condition. Figure 13 through Figure 17 show the total V_{DD1} and V_{DD2} supply current as a function of data rate for [ADuM7640/ADuM7641/ADuM7642/ADuM7643](#) channel configurations.

INSULATION LIFETIME

All insulation structures eventually break down when subjected to voltage stress over a sufficiently long period. The rate of insulation degradation depends on the characteristics of the voltage waveform applied across the insulation. In addition to the testing performed by the regulatory agencies, Analog Devices carries out an extensive set of evaluations to determine the lifetime of the insulation structure within the [ADuM7640/ADuM7641/ADuM7642/ADuM7643](#) components.

Analog Devices performs accelerated life testing using voltage levels higher than the rated continuous working voltage. Acceleration factors for several operating conditions are determined. These factors allow calculation of the time to failure at the actual working voltage. The values shown in Table 18 summarize the peak voltage for 50 years of service life for a bipolar ac operating condition and the maximum working voltages. In many cases, the approved working voltage is higher than the 50-year service life voltage. Operation at these high working voltages can lead to shortened insulation life in some cases.

The insulation lifetime of the [ADuM7640/ADuM7641/ADuM7642/ADuM7643](#) depends on the voltage waveform type imposed across the isolation barrier. The *iCoupler* insulation structure degrades at different rates depending on whether the waveform is bipolar ac, unipolar ac, or dc. Figure 24, Figure 25, and Figure 26 illustrate these different isolation voltage waveforms.

Bipolar ac voltage is the most stringent environment. The goal of a 50-year operating lifetime under the bipolar ac condition determines the Analog Devices recommended maximum working voltage.

In the case of unipolar ac or dc voltage, the stress on the insulation is significantly lower. This allows operation at higher working voltages while still achieving a 50-year service life. The working voltages listed in Table 18 can be applied while maintaining the 50-year minimum lifetime, provided that the voltage conforms to either the unipolar ac or dc voltage case. Any cross-insulation voltage waveform that does not conform to Figure 25 or Figure 26 should be treated as a bipolar ac waveform, and its peak voltage should be limited to the 50-year lifetime voltage value listed in Table 18.

The voltage presented in Figure 25 is shown as sinusoidal for illustration purposes only. It is meant to represent any voltage waveform varying between 0 V and some limiting value. The limiting value can be positive or negative, but the voltage cannot cross 0 V.

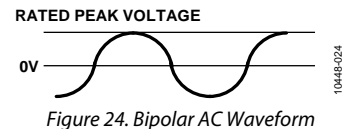

Figure 24. Bipolar AC Waveform

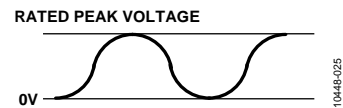

Figure 25. Unipolar AC Waveform

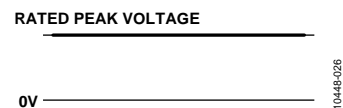
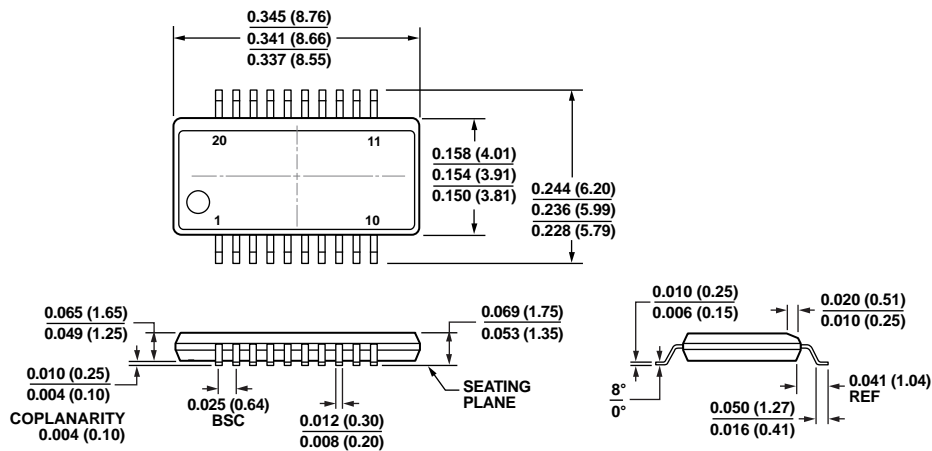

Figure 26. DC Waveform

OUTLINE DIMENSIONS



COMPLIANT TO JEDEC STANDARDS MO-137-AD
 CONTROLLING DIMENSIONS ARE IN INCHES; MILLIMETER DIMENSIONS
 (IN PARENTHESES) ARE ROUNDED-OFF INCH EQUIVALENTS FOR
 REFERENCE ONLY AND ARE NOT APPROPRIATE FOR USE IN DESIGN.

Figure 27. 20-Lead Shrink Small Outline Package [QSOP]
 (RQ-20)

Dimensions shown in inches and (millimeters)

08-19-2008-A

ORDERING GUIDE

Model ¹	Number of Inputs, V _{DD1} Side	Number of Inputs, V _{DD2} Side	Maximum Data Rate	Maximum Propagation Delay, 5 V	Maximum Pulse Width Distortion	Temperature Range	Package Description	Package Option
ADuM7640ARQZ	6	0	1 Mbps	20 ns	75 ns	-40°C to +105°C	20-Lead QSOP	RQ-20
ADuM7640ARQZ-RL7	6	0	1 Mbps	20 ns	75 ns	-40°C to +105°C	20-Lead QSOP, 7" Tape and Reel	RQ-20
ADuM7640CRQZ	6	0	25 Mbps	14 ns	50 ns	-40°C to +105°C	20-Lead QSOP	RQ-20
ADuM7640CRQZ-RL7	6	0	25 Mbps	14 ns	50 ns	-40°C to +105°C	20-Lead QSOP, 7" Tape and Reel	RQ-20
ADuM7641ARQZ	5	1	1 Mbps	20 ns	75 ns	-40°C to +105°C	20-Lead QSOP	RQ-20
ADuM7641ARQZ-RL7	5	1	1 Mbps	20 ns	75 ns	-40°C to +105°C	20-Lead QSOP, 7" Tape and Reel	RQ-20
ADuM7641CRQZ	5	1	25 Mbps	14 ns	50 ns	-40°C to +105°C	20-Lead QSOP	RQ-20
ADuM7641CRQZ-RL7	5	1	25 Mbps	14 ns	50 ns	-40°C to +105°C	20-Lead QSOP, 7" Tape and Reel	RQ-20
ADuM7642ARQZ	4	2	1 Mbps	20 ns	75 ns	-40°C to +105°C	20-Lead QSOP	RQ-20
ADuM7642ARQZ-RL7	4	2	1 Mbps	20 ns	75 ns	-40°C to +105°C	20-Lead QSOP, 7" Tape and Reel	RQ-20
ADuM7642CRQZ	4	2	25 Mbps	14 ns	50 ns	-40°C to +105°C	20-Lead QSOP	RQ-20
ADuM7642CRQZ-RL7	4	2	25 Mbps	14 ns	50 ns	-40°C to +105°C	20-Lead QSOP, 7" Tape and Reel	RQ-20
ADuM7643ARQZ	3	3	1 Mbps	20 ns	75 ns	-40°C to +105°C	20-Lead QSOP	RQ-20
ADuM7643ARQZ-RL7	3	3	1 Mbps	20 ns	75 ns	-40°C to +105°C	20-Lead QSOP, 7" Tape and Reel	RQ-20
ADuM7643CRQZ	3	3	25 Mbps	14 ns	50 ns	-40°C to +105°C	20-Lead QSOP	RQ-20
ADuM7643CRQZ-RL7	3	3	25 Mbps	14 ns	50 ns	-40°C to +105°C	20-Lead QSOP, 7" Tape and Reel	RQ-20

¹ Z = RoHS Compliant Part.

Mouser Electronics

Authorized Distributor

Click to View Pricing, Inventory, Delivery & Lifecycle Information:

[Analog Devices Inc.:](#)

[ADUM7641ARQZ](#) [ADUM7641ARQZ-RL7](#) [ADUM7641CRQZ](#) [ADUM7641CRQZ-RL7](#)