

N-Channel Switch

J111, J112, J113, MMBFJ111, MMBFJ112, MMBFJ113

Features

- This Device is Designed for Low Level Analog Switching, Sample and Hold Circuits and Chopper Stabilized Amplifiers
- Sourced from Process 51
- Source & Drain are Interchangeable
- These are Pb-Free Devices

ABSOLUTE MAXIMUM RATINGS (T_A = 25°C unless otherwise noted) (Note 1, 2)

Symbol	Parameter	Value	Unit
V _{DG}	Drain-Gate Voltage	35	V
V _{GS}	Gate-Source Voltage	-35	V
I _{GF}	Forward Gate Current	50	mA
T _J , T _{STG}	Operating and Storage Junction Temperature Range	-55 to 150	°C

Stresses exceeding those listed in the Maximum Ratings table may damage the device. If any of these limits are exceeded, device functionality should not be assumed, damage may occur and reliability may be affected.

1. These ratings are based on a maximum junction temperature of 150°C.
2. These are steady-state limits. ON Semiconductor should be consulted on applications involving pulsed or low-duty-cycle operations.

THERMAL CHARACTERISTICS (T_A = 25°C unless otherwise noted)

Symbol	Parameter	Max		Unit
		J111 / J112 / J113 (Note 3)	MMBFJ111 / MMBFJ112 / MMBFJ113 (Note 4)	
P _D	Total Device Dissipation	625	350	mW
	Derate Above 25°C	5.0	2.8	mW/°C
R _{θJC}	Thermal Resistance, Junction-to-Case	125	-	°C/W
R _{θJA}	Thermal Resistance, Junction-to-Ambient	200	357	°C/W

3. PCB size: FR-4, 76 mm x 114 mm x 1.57 mm (3.0 inch x 4.5 inch x 0.062 inch) with minimum land pattern size.
4. Device mounted on FR-4 PCB 36 mm x 18 mm x 1.5 mm; mounting pad for the collector lead minimum 6 cm².

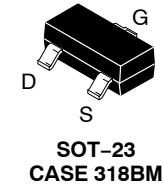
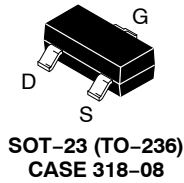
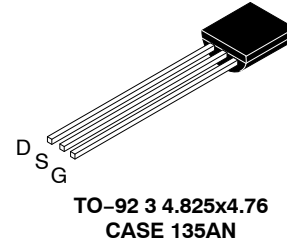
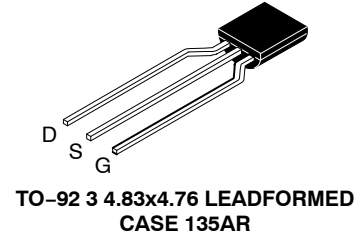

MARKING DIAGRAMS

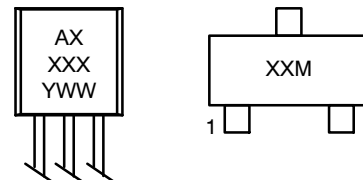

XXXX, XX = Specific Device Code
A = Assembly Plant Code
Y = Year
WW = Work Week
M = Date Code

ORDERING INFORMATION

See detailed ordering and shipping information on page 6 of this data sheet.

J111, J112, J113, MMBFJ111, MMBFJ112, MMBFJ113

ELECTRICAL CHARACTERISTICS (T_J = 25°C unless otherwise noted)

Symbol	Parameter	Test Condition	Min	Max	Unit
--------	-----------	----------------	-----	-----	------

OFF CHARACTERISTICS

V _{(BR)GSS}	Gate-Source Breakdown Voltage	I _G = -1.0 μA, V _{DS} = 0	-35	-	V	
I _{GSS}	Gate Reverse Current	V _{GS} = -15 V, V _{DS} = 0	-	-1.0	nA	
V _{GS(off)}	Gate-Source Cut-Off Voltage	V _{DS} = 5 V, I _D = 1.0 μA	111	-3.0	-10.0	V
			112	-1.0	-5.0	
			113	-0.5	-3.0	
I _{D(off)}	Drain Cutoff Leakage Current	V _{DS} = 5.0 V, V _{GS} = -10 V	-	1.0	nA	

ON CHARACTERISTICS

I _{DSS}	Zero-Gate Voltage Drain Current (Note 5)	V _{DS} = 15 V, V _{GS} = 0	111	20	-	mA
			112	5.0	-	
			113	2.0	-	
r _{DS(on)}	Drain-Source On Resistance	V _{DS} ≤ 0.1 V, V _{GS} = 0	111	-	30	Ω
			112	-	50	
			113	-	100	

SMALL SIGNAL CHARACTERISTICS

C _{dg(on)} C _{sg(on)}	Drain-Gate & Source-Gate On Capacitance	V _{DS} = 0, V _{GS} = 0, f = 1.0 MHz	-	28	pF
C _{dg(off)}	Drain-Gate Off Capacitance	V _{DS} = 0, V _{GS} = -10 V, f = 1.0 MHz	-	5.0	pF
C _{sg(off)}	Source-Gate Off Capacitance	V _{DS} = 0, V _{GS} = -10 V, f = 1.0 MHz	-	5.0	pF

Product parametric performance is indicated in the Electrical Characteristics for the listed test conditions, unless otherwise noted. Product performance may not be indicated by the Electrical Characteristics if operated under different conditions.

5. Pulse test: pulse width ≤ 300 μs, duty cycle ≤ 2%.

TYPICAL PERFORMANCE CHARACTERISTICS

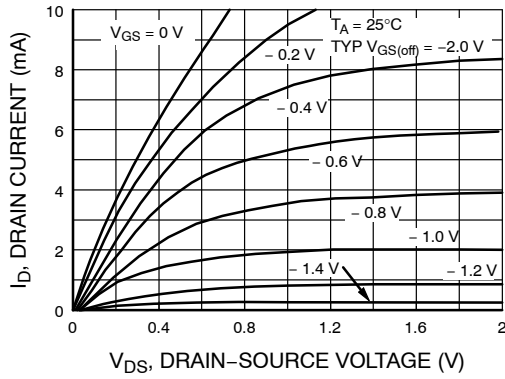

Figure 1. Common Drain-Source



Figure 2. Parameter Interactions



Figure 3. Transfer Characteristics



Figure 4. Transfer Characteristics

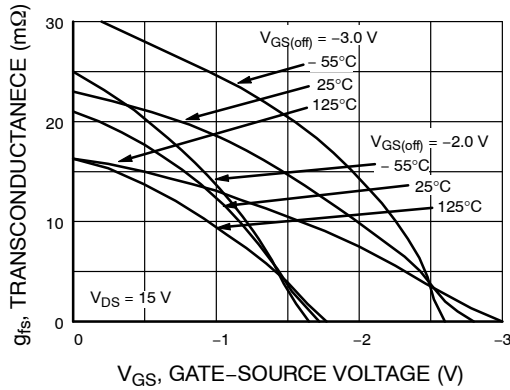

Figure 5. Transfer Characteristics



Figure 6. Transfer Characteristics

TYPICAL PERFORMANCE CHARACTERISTICS (CONTINUED)



Figure 7. On Resistance vs. Drain Current

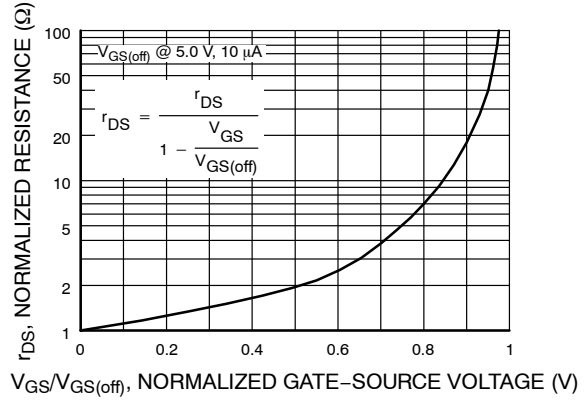

Figure 8. Normalized Drain Resistance vs. Bias Voltage

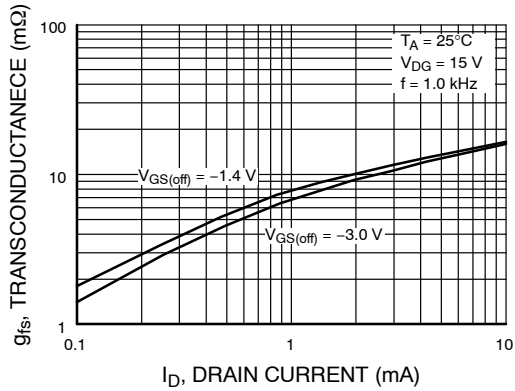

Figure 9. Transconductance vs. Drain Current

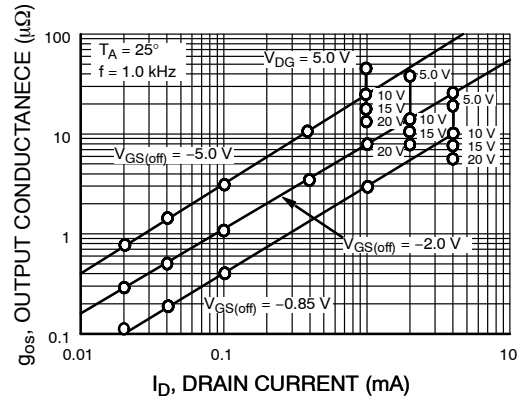

Figure 10. Output Conductance vs. Drain Current



Figure 11. Capacitance vs. Voltage



Figure 12. Noise Voltage vs. Frequency

J111, J112, J113, MMBFJ111, MMBFJ112, MMBFJ113

TYPICAL PERFORMANCE CHARACTERISTICS (CONTINUED)

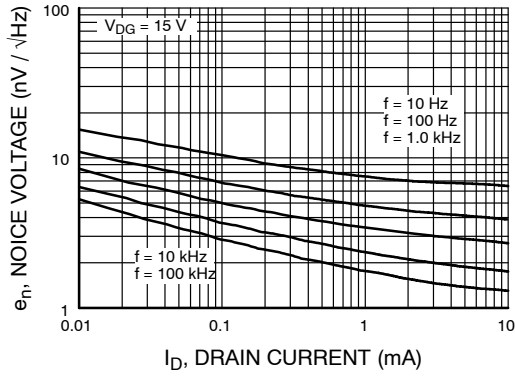

Figure 13. Noise Voltage vs. Current

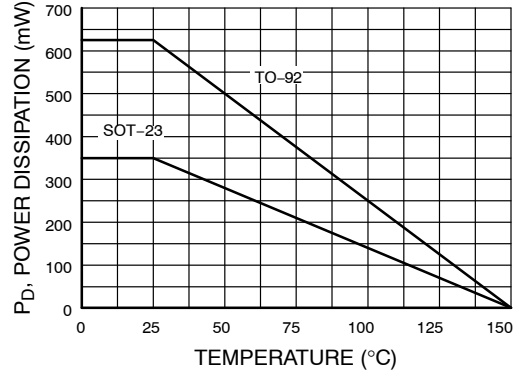

Figure 14. Power Dissipation vs. Ambient Temperature

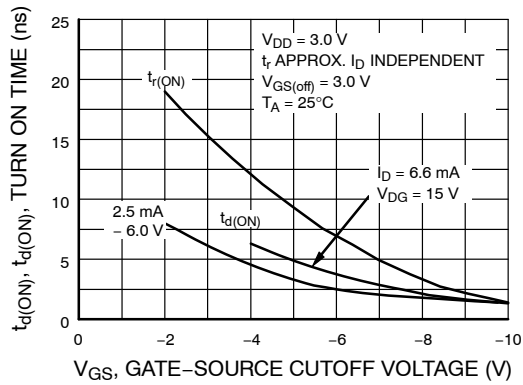

Figure 15. Switching Turn-On Time vs. Gate-Source Voltage

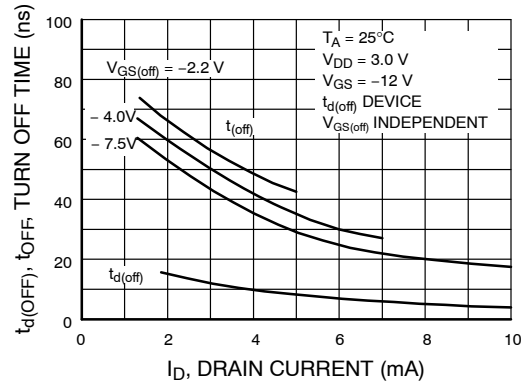

Figure 16. Switching Turn-Off Time vs. Drain Current

J111, J112, J113, MMBFJ111, MMBFJ112, MMBFJ113

ORDERING INFORMATION

Part Number	Top Mark	Package	Shipping [†]
J111	AJ 111 YWW	TO-92 3L (Pb-Free)	10000 Units / Bulk
J111-D26Z	AJ 111 YWW	TO-92 3L (Pb-Free)	2000 / Tape & Reel
J111-D74Z	AJ 111 YWW	TO-92 3L (Pb-Free)	2000 / Ammo
J112	AJ 112 YWW	TO-92 3L (Pb-Free)	10000 Units / Bulk
J112-D26Z	AJ 112 YWW	TO-92 3L (Pb-Free)	2000 / Tape & Reel
J112-D27Z	AJ 112 YWW	TO-92 3L (Pb-Free)	2000 / Tape & Reel
J112-D74Z	AJ 112 YWW	TO-92 3L (Pb-Free)	2000 / Ammo
J113	AJ 113 YWW	TO-92 3L (Pb-Free)	10000 Units / Bulk
J113-D74Z	AJ 113 YWW	TO-92 3L (Pb-Free)	2000 / Ammo
MMBFJ111	6P	SOT-23 3L (Pb-Free)	3000 / Tape & Reel
MMBFJ112	6R	SOT-23 3L (Pb-Free)	3000 / Tape & Reel
MMBFJ113	6S	SOT-23 3L (Pb-Free)	3000 / Tape & Reel

†For information on tape and reel specifications, including part orientation and tape sizes, please refer to our Tape and Reel Packaging Specifications Brochure, BRD8011/D.

TO-92 3 4.825x4.76
CASE 135AN
ISSUE O

DATE 31 JUL 2016

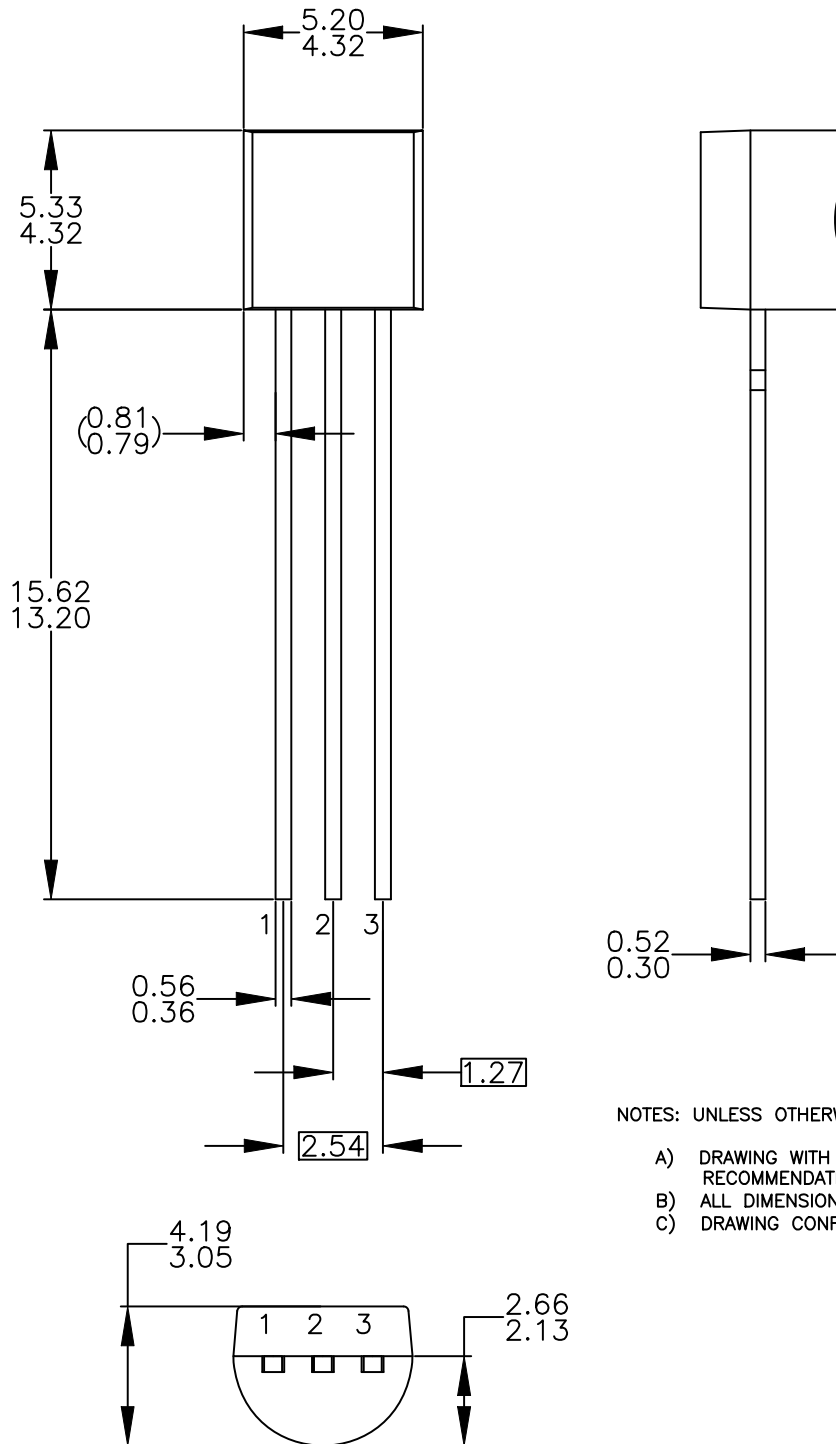

NOTES: UNLESS OTHERWISE SPECIFIED

- A) DRAWING WITH REFERENCE TO JEDEC TO-92 RECOMMENDATIONS.
- B) ALL DIMENSIONS ARE IN MILLIMETERS.
- C) DRAWING CONFORMS TO ASME Y14.5M-2009.

DOCUMENT NUMBER:	98AON13880G	Electronic versions are uncontrolled except when accessed directly from the Document Repository. Printed versions are uncontrolled except when stamped "CONTROLLED COPY" in red.
DESCRIPTION:	TO-92 3 4.825X4.76	PAGE 1 OF 1

onsemi and ONSEMI are trademarks of Semiconductor Components Industries, LLC dba onsemi or its subsidiaries in the United States and/or other countries. onsemi reserves the right to make changes without further notice to any products herein. onsemi makes no warranty, representation or guarantee regarding the suitability of its products for any particular purpose, nor does onsemi assume any liability arising out of the application or use of any product or circuit, and specifically disclaims any and all liability, including without limitation special, consequential or incidental damages. onsemi does not convey any license under its patent rights nor the rights of others.

TO-92 3 4.83x4.76 LEADFORMED
CASE 135AR
ISSUE O

DATE 30 SEP 2016

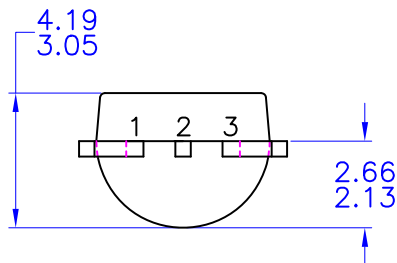
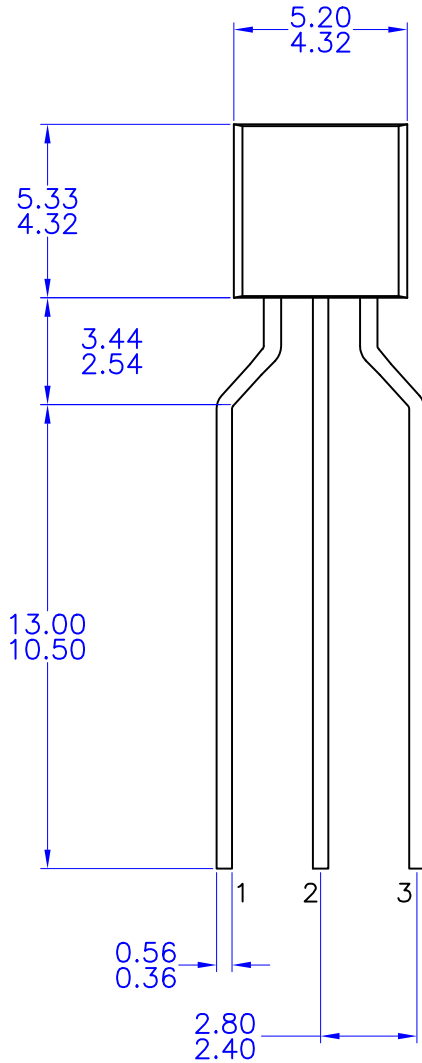

NOTES: UNLESS OTHERWISE SPECIFIED

- A) DRAWING WITH REFERENCE TO JEDEC TO-92 RECOMMENDATIONS.
- B) ALL DIMENSIONS ARE IN MILLIMETERS.
- C) DRAWING CONFORMS TO ASME Y14.5M-1994

DOCUMENT NUMBER:	98AON13879G	Electronic versions are uncontrolled except when accessed directly from the Document Repository. Printed versions are uncontrolled except when stamped "CONTROLLED COPY" in red.
DESCRIPTION:	TO-92 3 4.83X4.76 LEADFORMED	PAGE 1 OF 1

onsemi and ONSEMI are trademarks of Semiconductor Components Industries, LLC dba onsemi or its subsidiaries in the United States and/or other countries. onsemi reserves the right to make changes without further notice to any products herein. onsemi makes no warranty, representation or guarantee regarding the suitability of its products for any particular purpose, nor does onsemi assume any liability arising out of the application or use of any product or circuit, and specifically disclaims any and all liability, including without limitation special, consequential or incidental damages. onsemi does not convey any license under its patent rights nor the rights of others.

onsemi, **Onsemi**, and other names, marks, and brands are registered and/or common law trademarks of Semiconductor Components Industries, LLC dba "**onsemi**" or its affiliates and/or subsidiaries in the United States and/or other countries. **onsemi** owns the rights to a number of patents, trademarks, copyrights, trade secrets, and other intellectual property. A listing of **onsemi**'s product/patent coverage may be accessed at www.onsemi.com/site/pdf/Patent-Marking.pdf. **onsemi** reserves the right to make changes at any time to any products or information herein, without notice. The information herein is provided "as-is" and **onsemi** makes no warranty, representation or guarantee regarding the accuracy of the information, product features, availability, functionality, or suitability of its products for any particular purpose, nor does **onsemi** assume any liability arising out of the application or use of any product or circuit, and specifically disclaims any and all liability, including without limitation special, consequential or incidental damages. Buyer is responsible for its products and applications using **onsemi** products, including compliance with all laws, regulations and safety requirements or standards, regardless of any support or applications information provided by **onsemi**. "Typical" parameters which may be provided in **onsemi** data sheets and/or specifications can and do vary in different applications and actual performance may vary over time. All operating parameters, including "Typicals" must be validated for each customer application by customer's technical experts. **onsemi** does not convey any license under any of its intellectual property rights nor the rights of others. **onsemi** products are not designed, intended, or authorized for use as a critical component in life support systems or any FDA Class 3 medical devices or medical devices with a same or similar classification in a foreign jurisdiction or any devices intended for implantation in the human body. Should Buyer purchase or use **onsemi** products for any such unintended or unauthorized application, Buyer shall indemnify and hold **onsemi** and its officers, employees, subsidiaries, affiliates, and distributors harmless against all claims, costs, damages, and expenses, and reasonable attorney fees arising out of, directly or indirectly, any claim of personal injury or death associated with such unintended or unauthorized use, even if such claim alleges that **onsemi** was negligent regarding the design or manufacture of the part. **onsemi** is an Equal Opportunity/Affirmative Action Employer. This literature is subject to all applicable copyright laws and is not for resale in any manner.

ADDITIONAL INFORMATION

TECHNICAL PUBLICATIONS:

Technical Library: www.onsemi.com/design/resources/technical-documentation
onsemi Website: www.onsemi.com

ONLINE SUPPORT: www.onsemi.com/support

For additional information, please contact your local Sales Representative at www.onsemi.com/support/sales



Mouser Electronics

Authorized Distributor

Click to View Pricing, Inventory, Delivery & Lifecycle Information:

[onsemi:](#)

[J112](#) [MMBFJ111](#) [MMBFJ113](#) [J111](#) [J113](#) [MMBFJ112](#) [J113-D74Z](#) [J111-D26Z](#) [J111-D74Z](#) [J112-D26Z](#) [J112-D27Z](#)
[J112-D74Z](#)