

RoHS, ELV適合品
RoHS, ELV COMPLIANT

Note1. The soldering process is allowed up to twice under the same condition. However, the interval between the first and second process must be maintained at the room temperature.
1. リフロー回数: 2回, 但し, 2回目のリフローにおいては, 一度, 室温に戻すこと.
Note2. The temperature indicates the board surface temperature on the connector lead area.
2. リフロー温度の測定は, コネクタリード部の基板表面温度を測定のこと.
Note3. Hand soldering: 280~300°C, 2s max.
3. 手半田温度: 280~300°C, 2S以内
Note4. Coplanarity: 0.1 max.
4. 端子平坦度: 0.1以下
Note5. Recommended thickness of PCB: 1.6mm
5. 推奨基板厚: 1.6mm

RECOMMENDED REFLOW PROFILE	
IR reflow condition	IR リフロー条件
Preheating area 150°C for 60 to 120 seconds	予備加熱: 60~120秒, 150°C
Peak temperature: 230°C	ピーク温度: 230°C
Soldering area 235±15°C or 10 seconds max.	リフロー温度: 230~240°C, 10秒以内
230°C min. for 10-30 seconds	230°C以上: 10~30秒

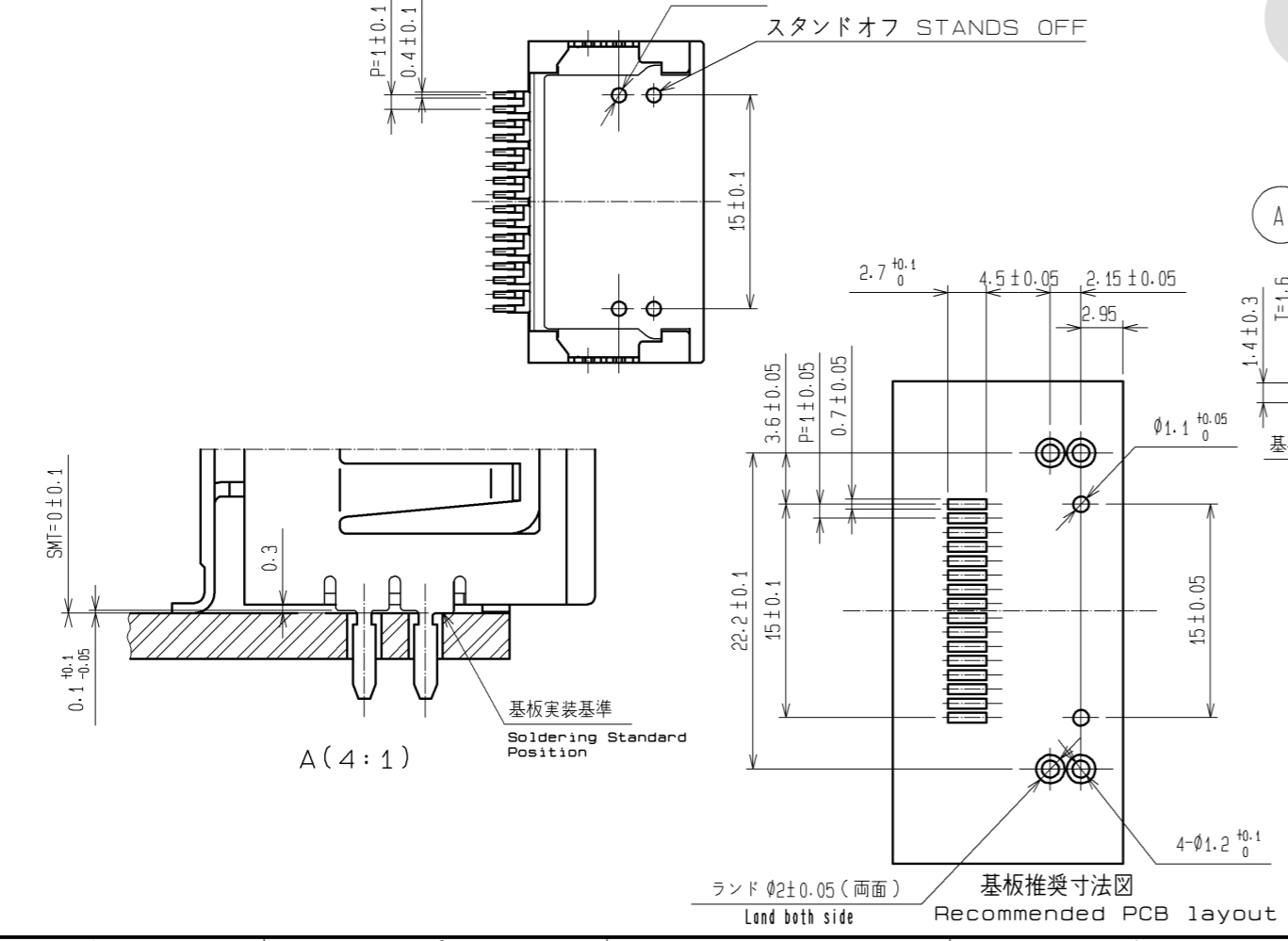
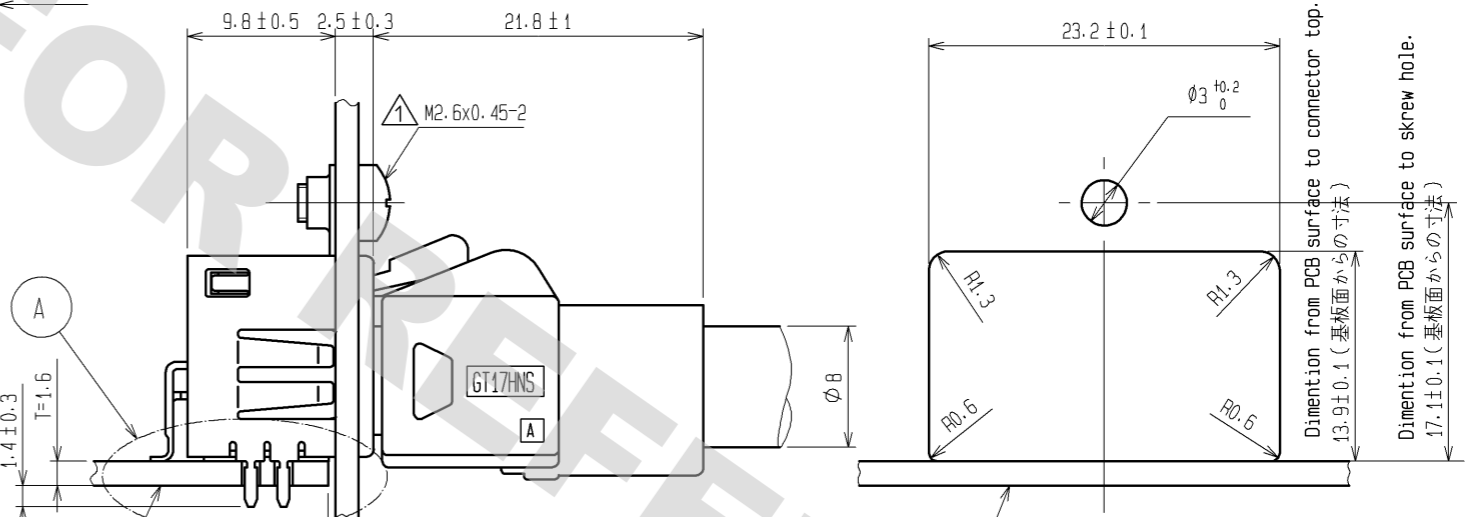
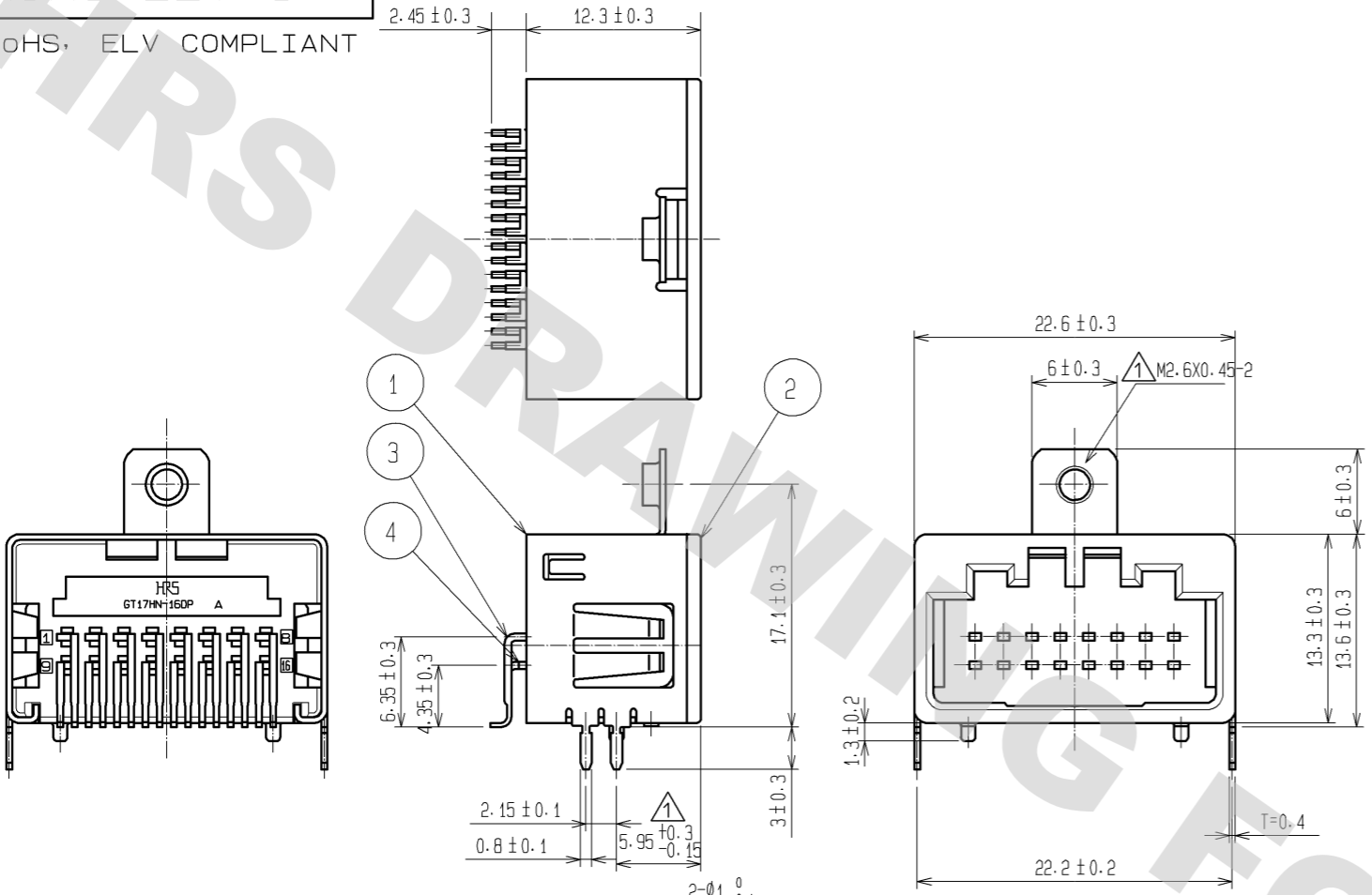
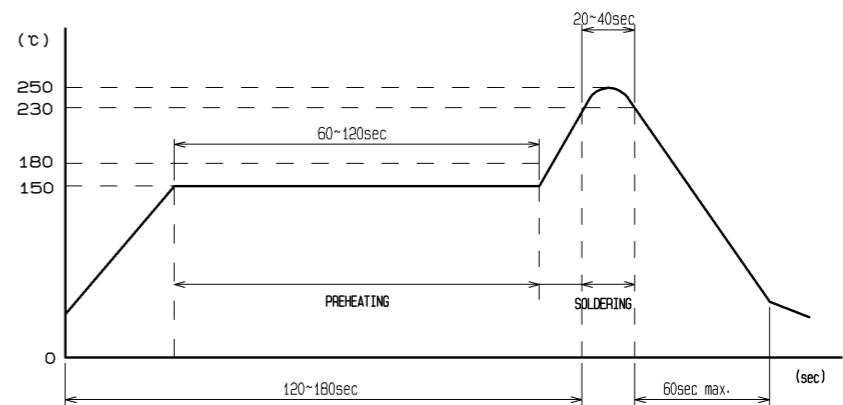

NO.	MATERIAL	FINISH	REMARKS	NO.	MATERIAL	FINISH	REMARKS
2	PPS	BROWN		5	PS	TRAY NATURAL	
1	COPPER ALLOY	TIN PLATING		4	BRASS	TIN PLATING	
				3	BRASS	TIN PLATING	

UNITS	SCALE	COUNT	DESCRIPTION OF REVISIONS	DESIGNED	CHECKED	DATE
mm	2:1	3	DIS-T-001319	NA. HARUBAYASHI	AR. SHIRAI	09.08.08

APPROVED	DATE	DRAWING NO.
KS. SATOH	09.04.13	EDC3-166859-00
CHECKED	DATE	PART NO.
NH. NAKATA	09.04.13	GT17HN-16DP-2H
DESIGNED	DATE	CODE NO.
MH. SHOUJI	09.04.08	CL767-0153-7-00
DRAWN	DATE	
MH. SHOUJI	09.04.08	

DRAWING FOR REFERENCE: This is subject to change without notice
08/11/2012

DRAWING FOR REFERENCE: This is subject to change without notice
08/11/2012

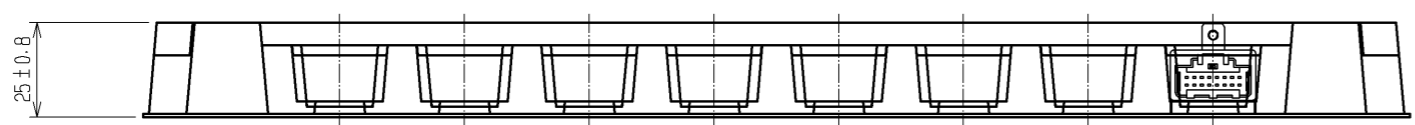
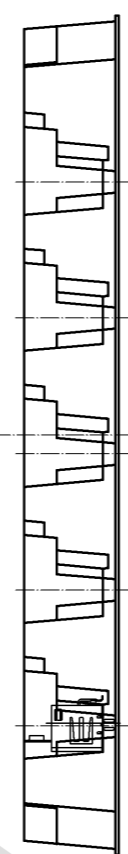
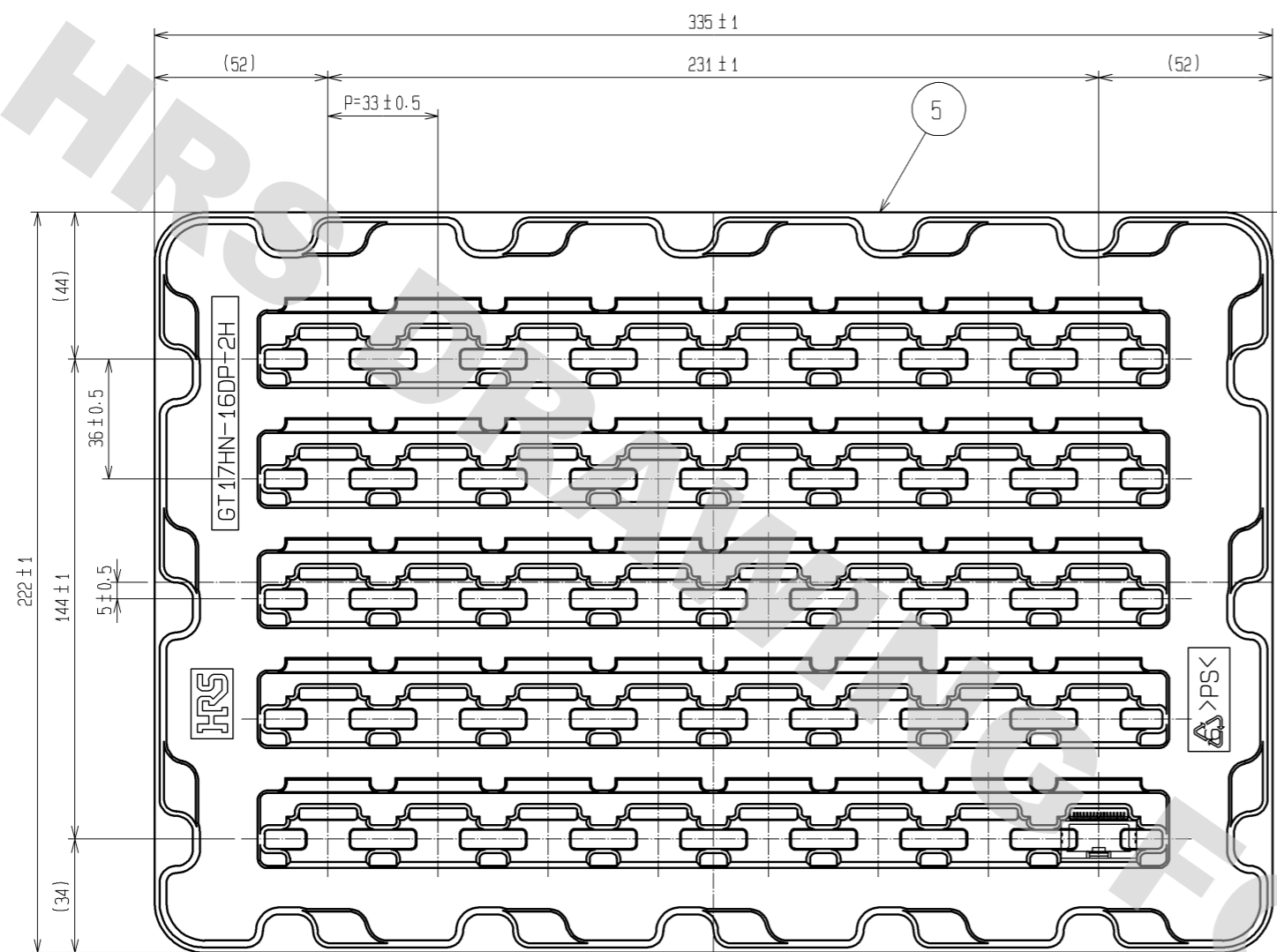

1トレー 40個 入り 40 PCS / TRAY

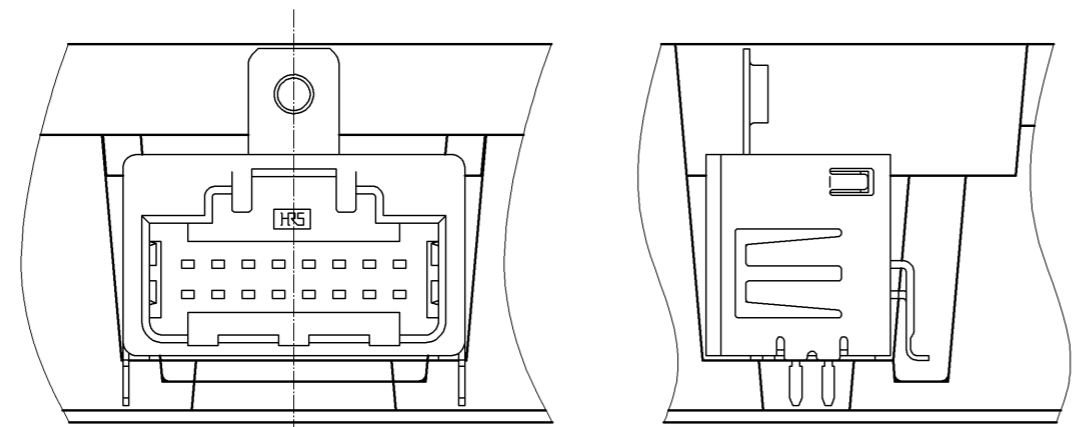

製品格納状態図(2:1)
PACKAGING CONDITION

梱包仕様
W=270・D=360・H=150のサイズのダンボール箱に下図のように製品を入れる。
ダンボール箱には納入先、製品名、入り数を明記する。

PACKAGING STYLE
BOX SIZE : W=270・D=360・H=150
The Delivery, a product name and a number are in the cardboard box .

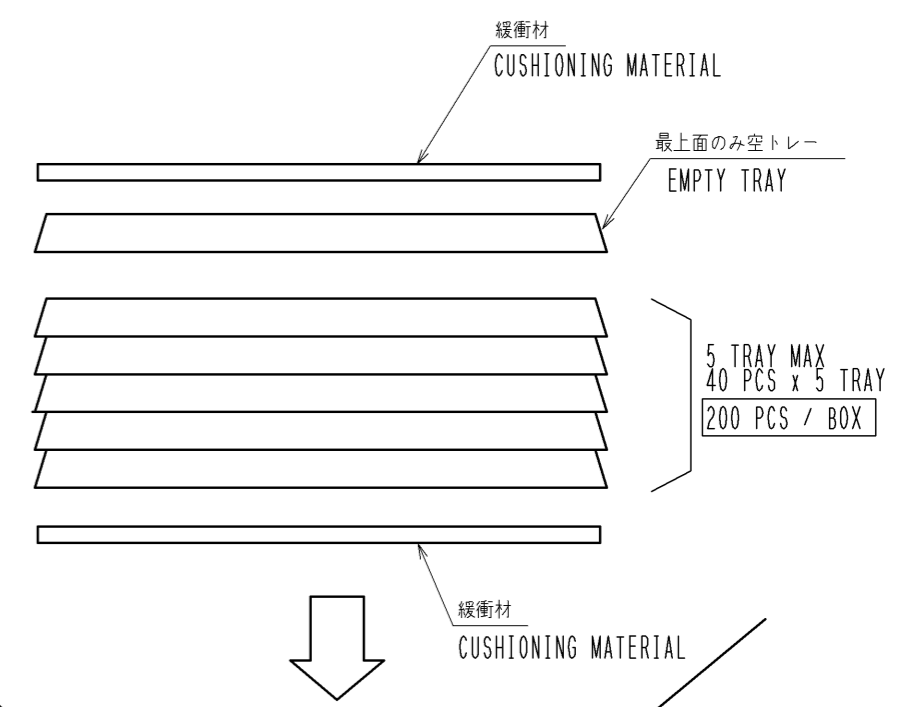

納入先	
品名	
数量	個

HRS	DRAWING NO.	EDC3-166859-00
	PART NO.	GT17HN-16DP-2H
	CODE NO.	CL767-0153-7-00
		2/2

Mouser Electronics

Authorized Distributor

Click to View Pricing, Inventory, Delivery & Lifecycle Information:

[Hirose Electric:](#)

[GT17HN-16DP-2H](#)