

**SERIES:** PQQ10W-S | **DESCRIPTION:** DC-DC CONVERTER

**FEATURES**

- 10W isolated output
- ultra wide 4:1 input range
- single regulated output
- high efficiency up to 88%
- short circuit and over-current protection
- 1500 Vdc isolation
- operating temperature -40°C ~ 85°C
- designed to meet EN/BS EN 62368
- control pin

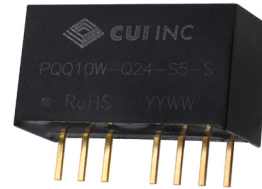

MODEL	input voltage		output voltage	output current		output power	ripple & noise <sup>1</sup>	efficiency <sup>2</sup>
	typ (Vdc)	range (Vdc)	(Vdc)	min (mA)	max (mA)	max (W)	max (mVp-p)	typ (%)
PQQ10W-Q24-S3-S	24	9~36	3.3	0	2,400	8	150	84
PQQ10W-Q24-S5-S	24	9~36	5.0	0	2,000	10	150	87
PQQ10W-Q24-S9-S	24	9~36	9.0	0	1,111	10	150	88
PQQ10W-Q24-S12-S	24	9~36	12.0	0	833	10	150	88
PQQ10W-Q24-S15-S	24	9~36	15.0	0	667	10	150	88
PQQ10W-Q24-S24-S	24	9~36	24.0	0	417	10	150	87

Notes: 1. Ripple and noise are measured at 20 MHz BW by "parallel cable" method. See figure 3.  
2. At nominal input voltage.

**PART NUMBER KEY**

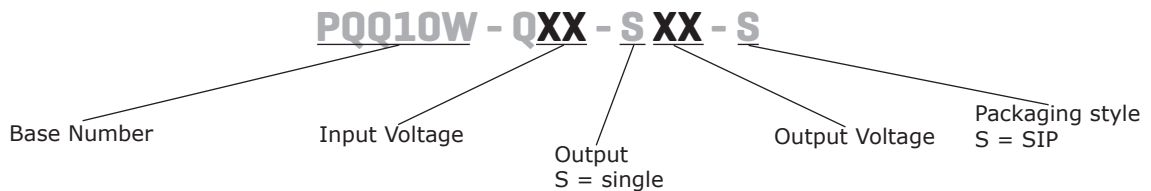

**INPUT**

parameter	conditions/description	min	typ	max	units
operating input voltage		9	24	40	Vdc
start-up voltage				9	Vdc
surge voltage	for maximum of 1 second	-0.7		50	Vdc
current	full load / no load				
	3.3 Vdc output		389/25	398/45	mA
	5 Vdc output		474/25	485/45	mA
	other outputs		474/9	485/18	mA
filter	capacitance filter				
CTRL	module on: CTRL pin open or pulled high (3.5-12 Vdc) module off: CTRL pin pulled low to GND (0-1.2 Vdc)				

**OUTPUT**

parameter	conditions/description	min	typ	max	units
maximum capacitive load	3.3 & 5 Vdc output			2,200	μF
	9 Vdc output			680	μF
	12 Vdc output			470	μF
	15 Vdc output			330	μF
	24 Vdc output			220	μF
voltage accuracy				±2	%
line regulation				±0.5	%
load regulation	5%~100% load			±1	%
switching frequency	PWM mode		500		kHz
transient recovery time	25% load step change		300	500	μS
transient response deviation	nominal input voltage				
	3.3 & 5 Vdc output		±5	±8	%
	other outputs		±3	±5	%
temperature coefficient	at full load			±0.03	%/°C

## PROTECTIONS

parameter	conditions/description	min	typ	max	units
over current protection		110		230	%
short circuit protection	continuous, auto recovery				

## SAFETY AND COMPLIANCE

parameter	conditions/description	min	typ	max	units
isolation voltage	input to output, for 1 minute with 1 mA max	1,500			Vdc
isolation resistance	input to output at 500 Vdc	1,000			MΩ
isolation capacitance	input to output, 100 kHz / 0.1 V		1,000		pF
safety approvals	designed to meet 62368: EN, BS EN				
EMI/EMC	CISPR32/EN 55032 Class B (see recommended circuit)				
ESD	IEC/EN61000-4-2 Contact ±6KV, perf. Criteria B				
radiated immunity	IEC/EN61000-4-3 10V/m, perf. Criteria A				
EFT/burst	IEC/EN61000-4-4 ±2KV (see recommended circuit), perf. Criteria B				
surge	IEC/EN61000-4-5 line to line ±2KV (see recommended circuit), perf. Criteria B				
conducted immunity	IEC/EN61000-4-6 3 Vr.m.s, perf. Criteria A				
MTBF	as per MIL-HDBK-217F, 25°C	1,000			K hours
RoHS	yes				

## ENVIRONMENTAL

parameter	conditions/description	min	typ	max	units
operating temperature	see derating curve	-40		85	°C
storage temperature		-55		125	°C
storage humidity	non-condensing	5		95	%
vibration	10-150Hz, 0.75mm, 5G, 90min. along X, Y and Z				

## MECHANICAL

parameter	conditions/description	min	typ	max	units
dimensions	22.00 × 9.50 × 12.00 [0.866 × 0.374 × 0.472 inch]				mm
case material	black plastic				
weight			5.5		g

## MECHANICAL DRAWING

units: mm [inch]  
 pin section tolerance: ±0.10[±0.004]  
 general tolerance: ±0.50[±0.020]

PIN Out	
PIN	Function
1	GND
2	Vin
3	Ctrl
5	NC
6	+Vo
7	0V
8	NC

NC: Pin to be isolated from circuitry.

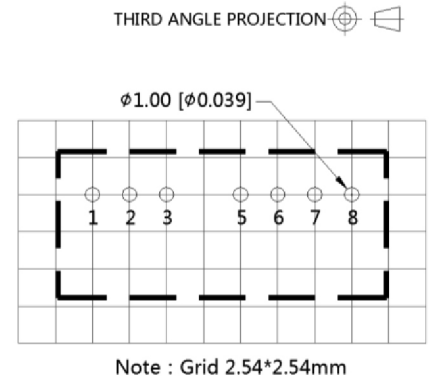
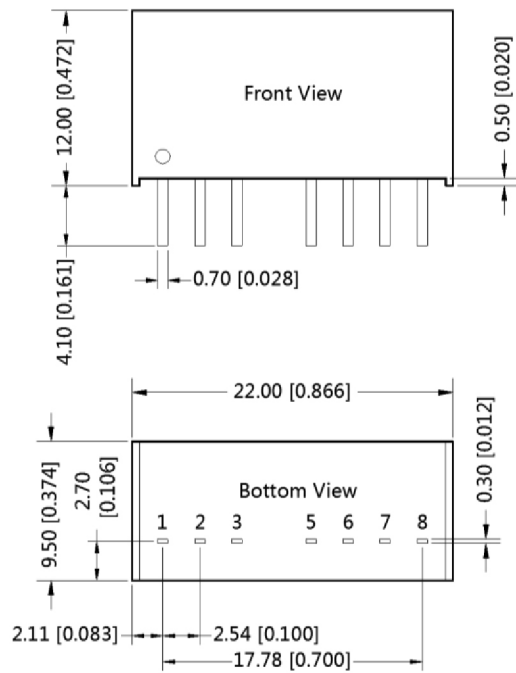

## DERATING CURVES

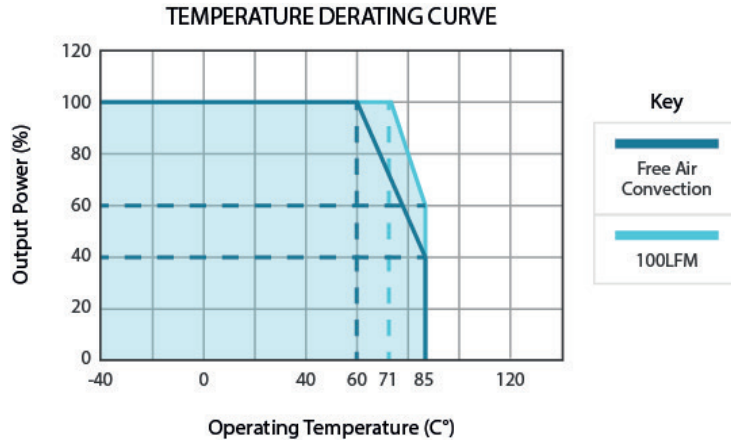

## EFFICIENCY CURVES

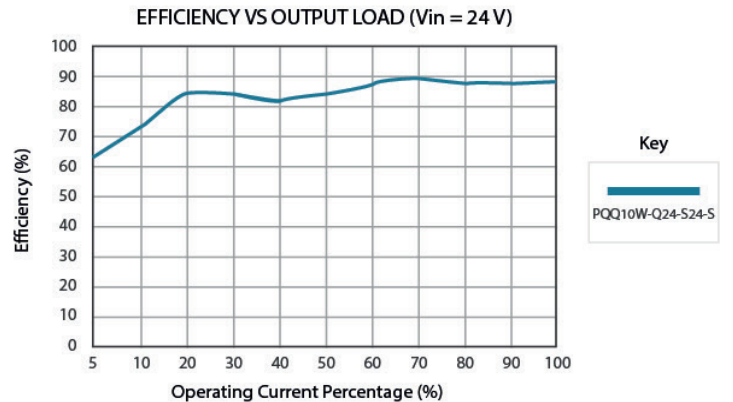
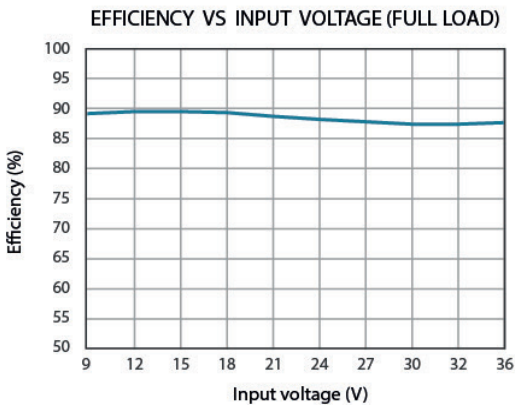
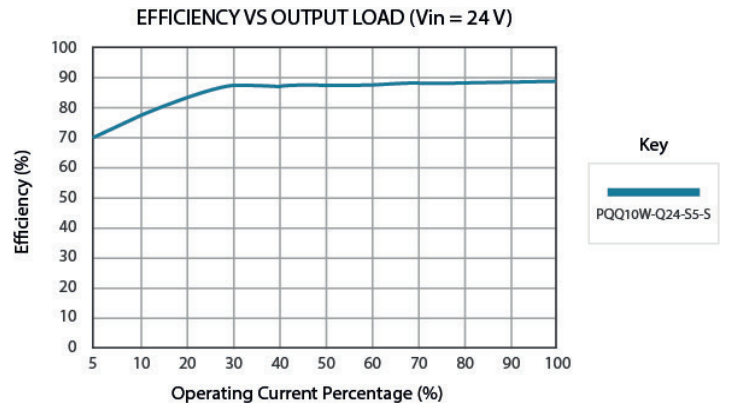
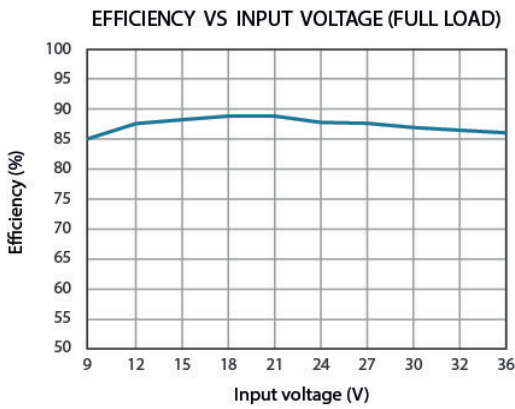

## APPLICATION CIRCUIT

Figure 1

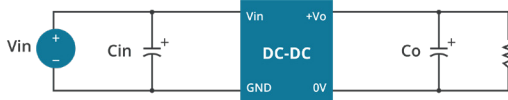
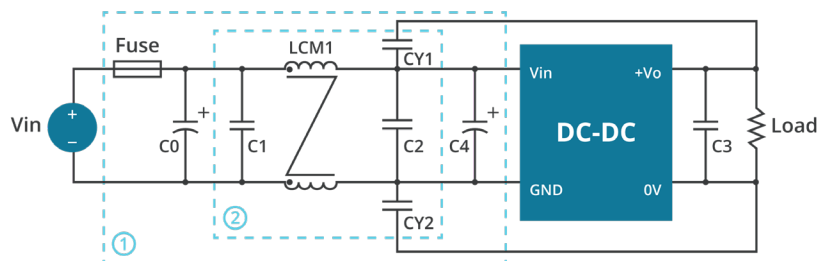

Table 1

Cin (μF)	Co (μF)
47	22

## EMC RECOMMENDED CIRCUIT

Figure 2



Note: For EMC tests part①was used for imunity and part②for emissions test.

Table 2

Model	Vin:24V
FUSE	Choose according to actual input current
C0, C4	330μF/50V
C1, C2	10μF/50V
C3	22μF/50V
LCM1	1.4-1.7mH (TN150-RH12.7*12.7*7.9)
CY1, CY2	1nF/2000Vac

## RIPPLE AND NOISE

Figure 3

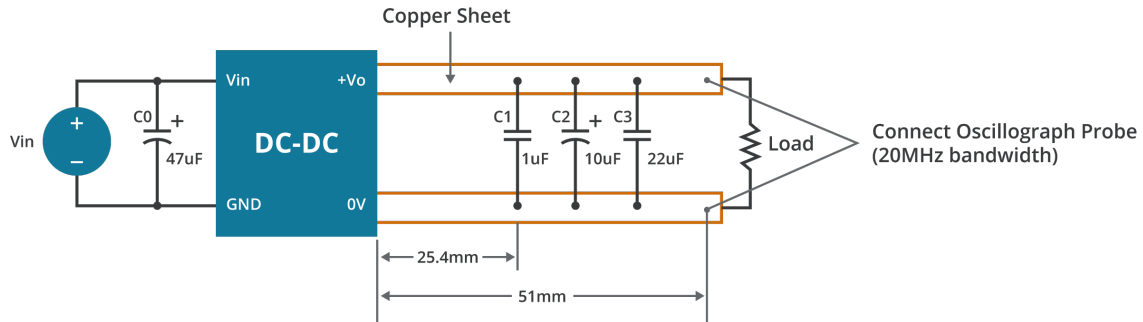

## REVISION HISTORY

rev.	description	date
1.0	initial release	09/29/2020
1.01	efficiency values updated and ripple and noise updated for 3 Vdc & 5 Vdc output models	09/26/2022
1.02	product image updated	10/17/2022
1.03	CE certification updated	11/22/2022
1.04	efficiency values updated	03/09/2023

The revision history provided is for informational purposes only and is believed to be accurate.



**Headquarters**  
20050 SW 112th Ave.  
Tualatin, OR 97062  
**800.275.4899**

Fax 503.612.2383  
**cui.com**  
techsupport@cui.com

CUI offers a two (2) year limited warranty. Complete warranty information is listed on our website.

CUI reserves the right to make changes to the product at any time without notice. Information provided by CUI is believed to be accurate and reliable. However, no responsibility is assumed by CUI for its use, nor for any infringements of patents or other rights of third parties which may result from its use.

CUI products are not authorized or warranted for use as critical components in equipment that requires an extremely high level of reliability. A critical component is any component of a life support device or system whose failure to perform can be reasonably expected to cause the failure of the life support device or system, or to affect its safety or effectiveness.