

SERIES: PDS1-S | DESCRIPTION: DC-DC CONVERTER
FEATURES

- 1 W isolated output
- smaller package
- single unregulated output
- 1,500 Vdc isolation
- short circuit protection
- extended temperature range (-40~105°C)
- antistatic protection up to 8kV
- high efficiency at light load
- efficiency up to 80%



MODEL	input voltage		output voltage (Vdc)	output current		output power max (W)	ripple and noise ² typ (mVp-p)	efficiency typ (%)
	typ (Vdc)	range (Vdc)		min (mA)	max (mA)			
PDS1-S3-S3-S	3.3	2.97~3.63	3.3	30	303	1	60	72
PDS1-S3-S5-S ^{1,*}	3.3	2.97~3.63	5	20	200	1	60	76
PDS1-S5-S3-S*	5	4.5~5.5	3.3	30	303	1	60	72
PDS1-S5-S5-S ^{1,*}	5	4.5~5.5	5	20	200	1	60	80
PDS1-S5-S9-S ^{1,*}	5	4.5~5.5	9	12	111	1	60	80
PDS1-S5-S12-S ^{1,*}	5	4.5~5.5	12	9	84	1	60	80
PDS1-S5-S15-S ^{1,*}	5	4.5~5.5	15	7	67	1	60	80
PDS1-S5-S24-S ^{1,*}	5	4.5~5.5	24	4	42	1	60	80
PDS1-S12-S3-S*	12	10.8~13.2	3.3	30	303	1	60	72
PDS1-S12-S5-S ^{1,*}	12	10.8~13.2	5	20	200	1	60	80
PDS1-S12-S9-S ^{1,*}	12	10.8~13.2	9	12	111	1	60	80
PDS1-S12-S12-S ¹	12	10.8~13.2	12	9	83	1	60	80
PDS1-S12-S15-S ^{1,*}	12	10.8~13.2	15	7	67	1	60	80
PDS1-S15-S5-S*	15	13.5~16.5	5	20	200	1	60	80
PDS1-S15-S12-S*	15	13.5~16.5	12	9	83	1	60	80
PDS1-S15-S15-S	15	13.5~16.5	15	7	67	1	60	80
PDS1-S24-S3-S*	24	21.6~26.4	3.3	30	303	1	60	72
PDS1-S24-S5-S ^{1,*}	24	21.6~26.4	5	20	200	1	60	80
PDS1-S24-S9-S ^{1,*}	24	21.6~26.4	9	12	111	1	60	80
PDS1-S24-S12-S ^{1,*}	24	21.6~26.4	12	9	84	1	60	80
PDS1-S24-S15-S ¹	24	21.6~26.4	15	7	67	1	60	80
PDS1-S24-S24-S ¹	24	21.6~26.4	24	4	42	1	60	80

Notes: 1. Model is UL approved.
 2. Ripple and noise are measured at 20 MHz BW by "parallel cable" method with 1 μ F ceramic and 10 μ F electrolytic capacitors on the output.
 3. * Discontinued model.

PART NUMBER KEY

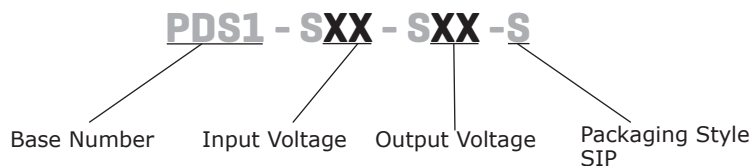

INPUT

parameter	conditions/description	min	typ	max	units
operating input voltage	3.3 Vdc input models	2.97	3.3	3.63	Vdc
	5 Vdc input models	4.5	5	5.5	Vdc
	12 Vdc input models	10.8	12	13.2	Vdc
	15 Vdc input models	13.5	15	16.5	Vdc
	24 Vdc input models	21.6	24	26.4	Vdc
surge voltage	for maximum of 1 second				
	3.3 Vdc input models	-0.7		5	Vdc
	5 Vdc input models	-0.7		9	Vdc
	12 Vdc input models	-0.7		18	Vdc
	15 Vdc input models	-0.7		21	Vdc
	24 Vdc input models	-0.7		30	Vdc
filter	capacitance filter				

OUTPUT

parameter	conditions/description	min	typ	max	units
line regulation	for Vin change of 1%				
	3.3 Vdc output models			±1.5	%
	all other models			±1.2	%
load regulation	measured from 10% load to full load				
	3.3 Vdc output models		18		%
	5 Vdc output models		12		%
	9 Vdc output models		8		%
	12 Vdc output models		7		%
	15 Vdc output models		6		%
	24 Vdc output models		5		%
voltage accuracy	see tolerance envelope curves				
switching frequency	100% load, nominal input voltage		100		kHz
temperature coefficient	100% load			±0.03	%/°C

PROTECTIONS

parameter	conditions/description	min	typ	max	units
short circuit protection ¹	3 & 24 Vdc input models; PDS1-S5-S24-S all other models: continuous, automatic recovery			1	s

Notes: 1. The supply voltage must be discontinued at the end of the short circuit duration

SAFETY AND COMPLIANCE

parameter	conditions/description	min	typ	max	units
isolation voltage	input to output for 1 minute at 1 mA max.	1,500			Vdc
isolation resistance	input to output at 500 Vdc	1,000			MΩ
safety approvals ²	certified to 60950-1: UL designed to meet 62368: EN				
conducted/radiated emissions	CISPR32/EN55032, class B (external circuit required, see Figure 1)				
ESD	IEC/EN61000-4-2, class B, contact ±8kV				
MTBF	as per MIL-HDBK-217F at 25°C	3,500,000			hours
RoHS	2011/65/EU				

Note: 2. See specific models noted on page 1

ENVIRONMENTAL

parameter	conditions/description	min	typ	max	units
operating temperature	see derating curve	-40		105	°C
storage temperature		-55		125	°C
storage humidity	non-condensing			95	%
temperature rise	at full load, Ta = 25°C		25		°C

SOLDERABILITY

parameter	conditions/description	min	typ	max	units
hand soldering	1.5 mm from case for 10 seconds			300	°C
wave soldering	see wave soldering profile			260	°C

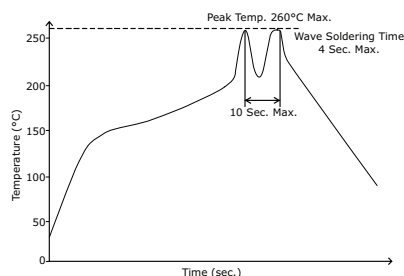

MECHANICAL

parameter	conditions/description	min	typ	max	units
dimensions	11.60 x 6.00 x 10.16 (0.457 x 0.236 x 0.4 inch)				mm
case material	plastic (UL94-V0)				
weight			1.3		g

MECHANICAL DRAWING

units: mm[inch]
tolerance: $\pm 0.25[\pm 0.010]$
pin section tolerance: $\pm 0.10[\pm 0.004]$

PIN CONNECTIONS	
PIN	Function
1	GND
2	Vin
3	0V
4	+Vo

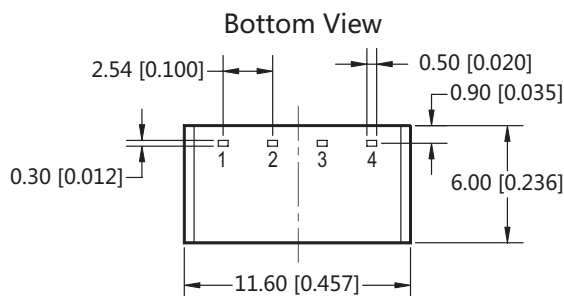
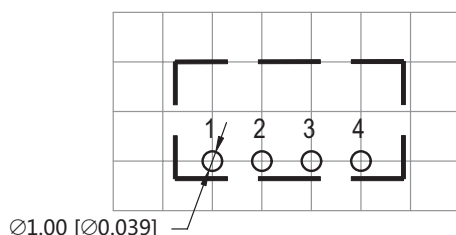
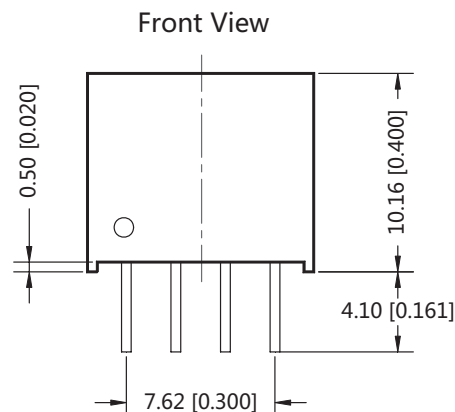

Note : Grid 2.54*2.54mm

DERATING CURVES

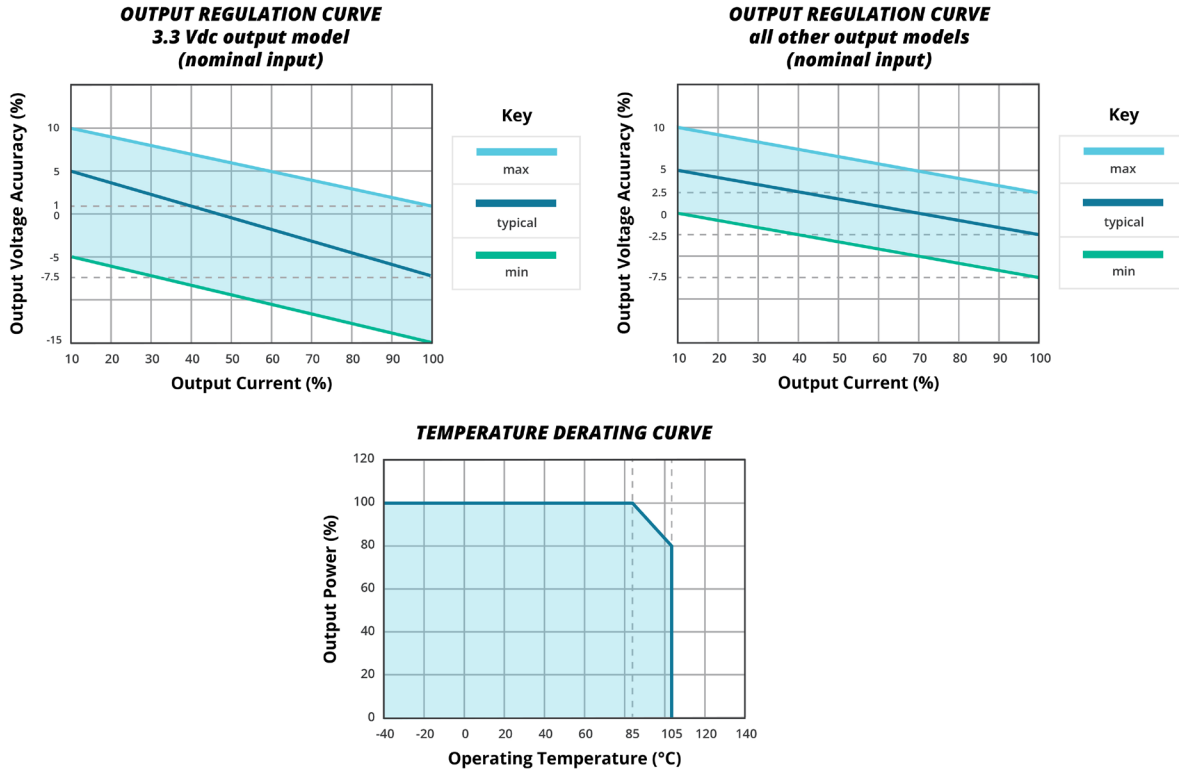

EMC RECOMMENDED CIRCUIT

Figure 1

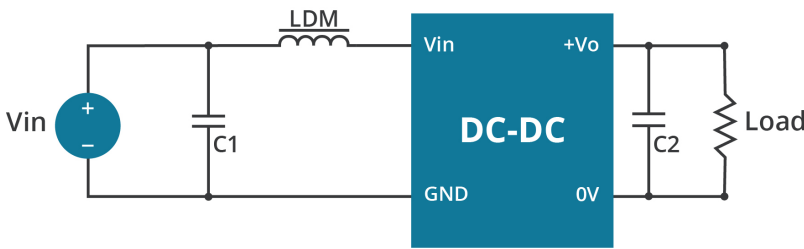

Table 1

Recommended external circuit components			
Vin (Vdc)	C1	C2	LDM
3.3	4.7μF/50V	10μF	6.8μH
5	4.7μF/50V	4.7μF	6.8μH
12	4.7μF/50V	2.2μF	6.8μH
15	4.7μF/50V	1μF	6.8μH
24	4.7μF/50V	0.47μF	6.8μH

TEST CONFIGURATION

Figure 2

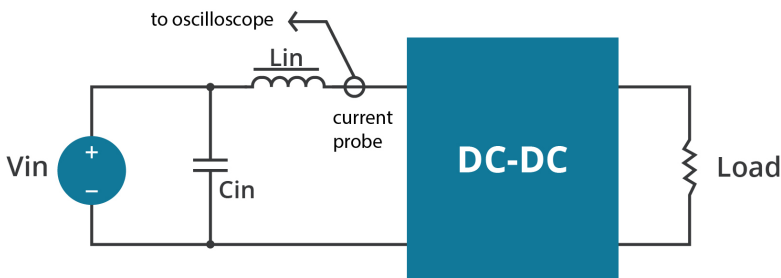

Table 2

External components	
Lin	4.7μH
Cin	220μF, ESR < 1.0Ω at 100 kHz

Note: 1. Input reflected-ripple current is measured with an inductor Lin and capacitor Cin to simulate source impedance.

APPLICATION NOTES

1. Output load requirement

To ensure this module can operate efficiently and reliably, the minimum output load may not be less than 10% of the full load during operation. If the actual output power is low, connect a resistor at the output end in parallel to increase the load.

2. Overload Protection

Under normal operating conditions, the output circuit of this product has no protection against overload. The simplest method to add this is to add a circuit breaker to the circuit.

3. Recommended circuit

If you want to further decrease the input/output ripple, you can increase the capacitance accordingly or choose capacitors with low ESR(see Figure 3 & Table 3). However, the capacitance of the output filter capacitor must be appropriate. If the capacitance is too high, a startup problem might arise. For every channel of the output, to ensure safe and reliable operation, the maximum capacitance must be less than the maximum capacitive load (see Table 4).

Figure 3

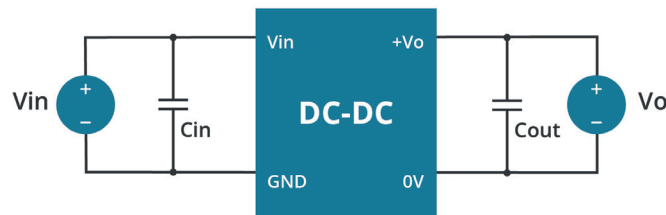

Table 3

Vin (Vdc)	Cin (μF)	Vout (Vdc)	Cout (μF)
3.3	4.7	3.3	10
5	4.7	5	10
12	2.2	9	4.7
15	2.2	12	2.2
24	1	15	1
--	--	24	0.47

Table 4

Vout (Vdc)	Max. Capacitive Load (μF)
3.3	220
5	220
12	220
15	220
24	220

Note:

1. Operation under minimum load will not damage the converter; however, they may not meet all specifications listed.
2. Max. capacitive load tested at input voltage range and full load.
3. It is recommended to use either ceramic capacitors or electrolytic capacitors on the input and the output. Using tantalum capacitors may increase the risk of failure.
4. All specifications measured at: Ta=25°C, humidity<75%, nominal input voltage and rated output load, unless otherwise specified.

REVISION HISTORY

rev.	description	date
1.0	initial release	03/19/2013
1.01	added model PDS1-S15-S12-S	07/29/2013
1.02	added model PDS1-S12-S3-S, updated spec	03/07/2014
1.03	added UL approval to some models	10/28/2014
1.04	updated tolerance envelope curves, corrected short circuit protection details	10/24/2018
1.05	safeties updated in features and safety line	01/18/2021
1.06	derating curves and circuit figures updated	07/06/2021
1.07	CE certification removed	11/01/2022
1.08	discontinued model PDS1-S24-S9-S	11/11/2022
1.09	discontinued model PDS1-S15-S12-S	02/02/2023
1.10	discontinued models	06/29/2023
1.11	discontinued models PDS1-S12-S5-S, PDS1-S24-S3-S, PDS1-S24-S5-S, PDS1-S3-S5-S, PDS1-S5-S12-S, PDS1-S5-S15-S, PDS1-S5-S24-S, PDS1-S5-S3-S & PDS1-S5-S9-S	01/11/2024
1.12	discontinued model PDS1-S5-S5-S	07/23/2024

The revision history provided is for informational purposes only and is believed to be accurate.



CUI INC

a bel group

Headquarters

15575 SW Sequoia Pkwy #100
Portland, OR 97224
800.275.4899

Fax 503.612.2383

cui.com

techsupport@cui.com

CUI offers a two (2) year limited warranty. Complete warranty information is listed on our website.

CUI reserves the right to make changes to the product at any time without notice. Information provided by CUI is believed to be accurate and reliable. However, no responsibility is assumed by CUI for its use, nor for any infringements of patents or other rights of third parties which may result from its use.

CUI products are not authorized or warranted for use as critical components in equipment that requires an extremely high level of reliability. A critical component is any component of a life support device or system whose failure to perform can be reasonably expected to cause the failure of the life support device or system, or to affect its safety or effectiveness.

Mouser Electronics

Authorized Distributor

Click to View Pricing, Inventory, Delivery & Lifecycle Information:

[CUI Inc.:](#)

[PDS1-S12-S12-S](#) [PDS1-S5-S5-S](#) [PDS1-S3-S5-S](#) [PDS1-S24-S12-S](#) [PDS1-S24-S5-S](#) [PDS1-S3-S3-S](#) [PDS1-S12-S5-S](#) [PDS1-S24-S15-S](#) [PDS1-S24-S3-S](#) [PDS1-S5-S12-S](#) [PDS1-S12-S15-S](#) [PDS1-S12-S3-S](#) [PDS1-S24-S24-S](#) [PDS1-S5-S3-S](#) [PDS1-S5-S15-S](#) [PDS1-S5-S24-S](#) [PDS1-S5-S9-S](#) [PDS1-S15-S15-S](#) [PDS1-S5-S7-S](#) [PDS1-S12-S9-S](#) [PDS1-S15-S5-S](#) [PDS1-S24-S9-S](#) [PDS1-S15-S12-S](#)