



CQB150W-110S SERIES 150 WATT 4:1 INPUT ISOLATED DC-DC CONVERTER

Features

- Efficiency Up to 92%
- Fixed Switching Frequency
- Regulated Outputs
- Remote On/Off
- Low No Load Power Consumption
- Fully Protected (OTP/OCP/OVP/UVLO)
- 3000Vdc I/O Isolation
- Operating Case Temperature -40 to +105°C
- Quarter Brick Size Meet Industrial Standard 2.28"x1.45"x0.5"
- CB Test Certificate IEC 60950-1 (Except 3.3&15Vout)
- UL 60950-1 2nd (Basic Insulation) Approval (Except 3.3&15Vout)
- EN 50155 Compliant with External Circuits
- Shock & Vibration EN 50155 (EN 61373) Compliant
- Fire & Smoke EN 45545-2 Compliant
- 3000m Operating Altitude
- Safety Meets IEC/EN/UL 62368-1



MODEL NUMBER	INPUT VOLTAGE	OUTPUT VOLTAGE	OUTPUT CURRENT		INPUT CURRENT		% EFF. (1)	CAPACITOR LOAD MAX.
			MIN.	MAX.	NO LOAD	FULL LOAD		
CQB150W-110S3V3	43-160 VDC	3.3 VDC	0 mA	30 A	10 mA	1.50 A	89	30000µF
CQB150W-110S05	43-160 VDC	5 VDC	0 mA	30 A	10 mA	1.50 A	91	30000µF
CQB150W-110S12	43-160 VDC	12 VDC	0 mA	12.5 A	10 mA	1.48 A	92	12500µF
CQB150W-110S15	43-160 VDC	15 VDC	0 mA	10 A	10 mA	1.50 A	91	10000µF
CQB150W-110S24	43-160 VDC	24 VDC	0 mA	6.3 A	10 mA	1.54 A	89	6300µF
CQB150W-110S28	43-160 VDC	28 VDC	0 mA	5.4 A	10 mA	1.54 A	89	5400µF
CQB150W-110S48	43-160 VDC	48 VDC	0 mA	3.2 A	10 mA	1.54 A	90.5	1000µF

NOTE:

1. Nominal Input Voltage 110 VDC.
2. An External Input Capacitor 220uF for All Models are Recommended to Reduce Input Ripple Voltage.
3. To Meet EN50155 and RIA12 refer to Application Note.

PART NUMBER

Series	Nominal Input Voltage	Number of Outputs	Nominal Output Voltage	Remote On/Off Logic	Mounting Inserts
CQB150W-	II	O	XX	L	-Y (Option)
CQB150W	110 : 110 VDC	S : Single	3V3 : 3.3VDC 05 : 05VDC 12 : 12VDC 15 : 15VDC 24 : 24VDC 28 : 28VDC 48 : 48VDC	None : Positive N : Negative	None : M3x0.5 Mounting Inserts -C : Clear Mounting Insert (3.2mm DIA.)

Part Number Example:

CQB150W-110S12N-C: Quarter Brick, 100W, 4:1 43-160Vdc Input, Single 12Vdc Output, Negative Logic, Clear Mounting Insert



CQB150W-110S Series

TECHNICAL SPECIFICATIONS

(All specifications are typical at nominal input, full load at 25°C unless otherwise noted.)

ABSOLUTE MAXIMUM RATINGS

PARAMETER	NOTES and CONDITIONS	Device	Min.	Typ.	Max.	Units
Input Voltage	Continuous	All	-0.3		160	V _{dc}
Input Surge Voltage	100ms	All			200	V _{dc}
Operating Case Temperature		All	-40		105	°C
Storage Temperature		All	-55		125	°C

INPUT CHARACTERISTICS

PARAMETER	NOTES and CONDITIONS	Device	Min.	Typ.	Max.	Units
Operating Input Voltage		All	43	110	160	V _{dc}
Input Under Voltage Lockout						
Turn-On Voltage Threshold		All	40.5	41.5	42.5	V _{dc}
Turn-Off Voltage Threshold		All	37	38	39	V _{dc}
Lockout Hysteresis Voltage		All		3.5		V _{dc}
Maximum Input Current	V _{in} =43V, Full load	All		4		A
No-Load Input Current	V _{in} =110V, I _o =0A	All		10		mA
Input Filter	Pi filter	All				
Inrush Current (I ² t)	As per ETS300 132-2.	All			0.1	A ² s
Input Reflected Ripple Current	P-P thru 12uH inductor, 5Hz to 20MHz	All		30		mA

OUTPUT CHARACTERISTICS

PARAMETER	NOTES and CONDITIONS	Device	Min.	Typ.	Max.	Units
Voltage Set Point Accuracy	V _{in} =110V, Full load, T _c =25°C	All	-1.0		+1.0	%
Output Voltage Regulation						
Load Regulation	Full load to no load	All			±0.2	%
Line Regulation	V _{in} =High line to low line, full load	All			±0.2	%
Temperature Coefficient	T _c =-40°C to 105°C	All			±0.02	%/°C
Output Voltage Ripple and Noise (5Hz to 20MHz bandwidth)						
Peak-to-Peak	Full load, 10uF tantalum and 1uF ceramic capacitors (for V _o =48V: Full load 10uF aluminum and 1uF ceramic capacitors)	3.3V _o			100	mV
		5V _o			100	
		12V _o			150	
		15V _o			150	
		24V _o			280	
		28V _o			280	
		48V _o			480	
RMS.	Full load, 10uF tantalum and 1uF ceramic capacitors (for V _o =48V: Full load 10uF aluminum and 1uF ceramic capacitors)	3.3V _o			40	mV
		5V _o			40	
		12V _o			60	
		15V _o			60	
		24V _o			100	
		28V _o			100	
		48V _o			200	
Output Current Range	V _{in} = 43 to 160V	See Model Number Table				A
Over Current Protection	Hiccup mode. Auto recovery	All	110	125	160	%
Over Voltage Protection	Limited voltage, % of nominal V _o	All	115	125	140	%
Short Circuit Protection		All	Continuous			
External Load Capacitance	Full load (resistive)	See Model Number Table				uF



CQB150W-110S Series

PARAMETER	NOTES and CONDITIONS	Device	Min.	Typ.	Max.	Units
Output Voltage Trim Range	$P_o \leq \text{max. rated power, } I_o \leq I_{o_max.}$	3.3Vout	-20		+10	%
		15Vout	-20		+10	
		Others	-10		+10	
Output Voltage Remote Sense Range	$P_o \leq \text{max. rated power, } I_o \leq I_{o_max.}$ % of nominal V_o	All			+10	%

EFFICIENCY

PARAMETER	NOTES and CONDITIONS	Device	Min.	Typ.	Max.	Units
100% Load	$V_{in}=110V$	See Model Number Table				%

DYNAMIC CHARACTERISTICS

PARAMETER	NOTES and CONDITIONS	Device	Min.	Typ.	Max.	Units
Output Voltage Current Transient						
Error Band	75% to 100% of $I_{o_max.}$ step load change $dI/dt=0.1A/us$ (within 1% V_{out} nominal)	All			± 5	%
Recovery Time						250
Turn-On Delay and Rise Time	Full load (constant resistive load)					
Turn-On Delay Time, From On/Off Control	$V_{on/off}$ to 10% V_{o_set}	All		30		ms
Turn-On Delay Time, From Input	$V_{in_min.}$ to 10% V_{o_set}	All		30		ms
Output Voltage Rise Time	10% V_{o_set} to 90% V_{o_set}	All		30		ms

ISOLATION CHARACTERISTICS

PARAMETER	NOTES and CONDITIONS	Device	Min.	Typ.	Max.	Units
Isolation Voltage	1 Minute; input to output	All			3000	V_{dc}
	1 Minute; input to case				2250	V_{dc}
	1 Minute; output to case				500	V_{ac}
Isolation Resistance	Input to output	All	100			M Ω
Isolation Capacitance	Input to output	All		1500		pF
	Input to case (base plate)			None		
	Output to case	3.3Vo		470		
		5Vo		470		
		12Vo		10000		
		15Vo		10000		
		24Vo		3000		
28Vo		3000				
48Vo		10000				

FEATURE CHARACTERISTICS

PARAMETER	NOTES and CONDITIONS	Device	Min.	Typ.	Max.	Units
Switching Frequency	Pulse width modulation (PWM), fixed	All	270	300	330	KHz
On/Off Control, Positive Remote On/Off Logic, Refer to -Vin Pin						
Logic Low (Module Off)	$V_{on/off}$ at $I_{on/off}=1.0mA$	All	0		1.2	V
Logic High (Module On)	$V_{on/off}$ at $I_{on/off}=0.0uA$	All	3.5 or Open Circuit		160	V
On/Off Control, Negative Remote On/Off Logic, Refer to -Vin Pin						
Logic High (Module Off)	$V_{on/off}$ at $I_{on/off}=0.0uA$	All	3.5 or Open Circuit		160	V
Logic Low (Module On)	$V_{on/off}$ at $I_{on/off}=1.0mA$	All	0		1.2	V
On/Off Current (for Both Remote On/Off Logic)	$I_{on/off}$ at $V_{on/off}=0V$	All		0.3	1	mA
Leakage Current (for Both Remote On/Off Logic)	Logic high, $V_{on/off}=15V$	All			30	uA
Off Converter Input Current	Shutdown input idle current	All		5	10	mA



CQB150W-110S Series

GENERAL SPECIFICATIONS

PARAMETER	NOTES and CONDITIONS	Device	Min.	Typ.	Max.	Units
Over Temperature Shutdown	Temperature at the center part of base plate, non-latching	All		110		°C
Over Temperature Recovery				100		
MTBF	I _o =100% of I _{o_max} ; MIL-HDBK - 217F_Notice 1, GB, 25°C	3.3Vo		875		K hours
		5Vo		720		
		12Vo		720		
		Others		840		
Weight		All		68		grams
Case Material	Plastic, DAP					
Base plate Material	Aluminum					
Potting Material	UL 94V-0					
Pin Material	Base: Copper Plating: Nickel with Matte Tin					
Shock/Vibration	MIL-STD-810F/EN 61373 Compliant					
Humidity	95% RH max. Non condensing					
Altitude	3000m Operating altitude, 12000m Transport altitude					
Thermal Shock	MIL-STD-810F					
Fire & Smoke	EN 45545-2 Compliant					
EMI	Meets EN 55011, EN 55032 & EN 50155 Compliant (with external filter)					Class A
ESD	EN 61000-4-2	Level 3: Air ±8kV, Contact ±6kV				Perf. Criteria A
Radiated immunity	EN 61000-4-3	Level 3: 80~1000MHz, 20V/m Level 2: 80~1000MHz, 3V/m for EN 55035:2017				Perf. Criteria A
Fast Transient	EN 61000-4-4	Level 3: On power input port, ±2kV, external input capacitor required Level 1: On power input port, ±0.5kV, external input capacitor required, for EN55035:2017				Perf. Criteria A
Surge	EN 61000-4-5	Level 4: Line to earth, ±4kV, Line to line, ±2kV (EN 50155) Level 1: Line to earth, ±0.5kV, for EN55035:2017 external components required				Perf. Criteria A
Conducted immunity	EN 61000-4-6	Level 3: 0.15~80MHz, 10V Level 2: 0.15~30MHz, 3V, 30~80MHz, 1V for EN 55035:2017				Perf. Criteria A
Magnetic Immunity	EN 61000-4-8	Level 1: 50Hz, 1A/m for EN55035:2017				Perf. Criteria A
Interruptions of Voltage Supply	EN 50155	Class S2: 10ms interruptions				Perf. Criteria B
Supply Change Over	EN 50155	Class C2: During a supply break of 30 ms				Perf. Criteria B
Application Note Link	CQB150W-110S Series App Notes					
Packaging Information Link	Packaging Information					



CQB150W-110S Series

Immunity to Environmental Conditions

Phenomenon	EN 50155; 2017 Reference Clause(s)	Reference Standard	Test Conditions	Result
Low Temperature Start-up test	13.4.4	EN 60068-2-1	Class OT6 Temperature: -40°C Duration: 2 hrs	Pass
Dry Heat Test	13.4.5	EN 60068-2-2	Class OT6 & ST2 Temperature: 85°C Duration: 6 hrs Extended temperature: 100°C Extended Duration: 10min	Pass
Low Temperature Storage Test	13.4.6	EN 60068-2-1	Temperature: -40°C Duration: 16 hrs	Pass
Cyclic Damp Heat Test	13.4.7	EN 60068-2-30	Temperature: 25°C - 55°C Humidity: 90% RH Duration: 48 hrs	Pass
Random Vibration Test	13.4.11	EN 61373	Temperature: 25°C±10°C Humidity: 50% ±25% RH Frequency range: 5 ~ 150 Hz Vertical: 1.01 m/s^2 Transverse: 0.450 m/s^2 Longitudinal: 0.700 m/s^2 Duration: 10 min / axis	Pass
Simulated Long Life Test at Increased Random Vibration Levels	13.4.11	EN 61373	Temperature: 25°C±10°C Humidity: 50% ±25% RH Frequency range: 5 ~ 150 Hz Vertical: 5.72 m/s^2 Transverse: 2.55 m/s^2 Longitudinal: 3.96 m/s^2 Duration: 5 hrs / axis	Pass
Shock Test	13.4.11	EN 61373	Temperature: 25°C±10°C Humidity: 50% ±25% RH Frequency range: 5 ~ 150 Hz ±Vertical: 30 m/s^2 ±Transverse: 30 m/s^2 ±Longitudinal: 50 m/s^2 Duration: 30ms x18 (Each axis 3 shocks)	Pass

EN 45545-2 Fire & Smoke Test Conditions

Item		Standard	Hazard Level
R22	Oxygen Index Test	EN 45545-2: 2013+A1:2015 EN ISO 4589-2: 2017	HL1, HL2, HL3
	Smoke Density Test	EN 45545-2: 2013+A1:2015 EN ISO 5659-2: 2017	HL1, HL2, HL3
	Smoke Toxicity Test	EN 45545-2: 2013+A1:2015 NF X70-100-1 and -2: 2006	HL1, HL2, HL3
R23	Oxygen Index Test	EN 45545-2: 2013+A1:2015 EN ISO 4589-2: 2017	HL1, HL2, HL3
	Smoke Density Test	EN 45545-2: 2013+A1:2015 EN ISO 5659-2: 2013	HL1, HL2, HL3
	Smoke Toxicity Test	EN 45545-2: 2013+A1:2015 NF X70-100-1 and -2: 2006	HL1, HL2, HL3
R24	Oxygen Index Test	EN 45545-2: 2013 EN ISO 4589-2	HL1, HL2, HL3
R25	Glow - Wire Test	EN 45545-2+A1:2016 EN 60695-2-11:2014	HL1, HL2, HL3
R26	Vertical Flame Test	EN 45545-2: 2013 EN 60695-11-10: 2013	HL1, HL2, HL3



CHARACTERISTIC CURVE

Power Derating Curve

CQB150W-110S3V3,24,28 Derating Curve without Heatsink (Vin=110V)

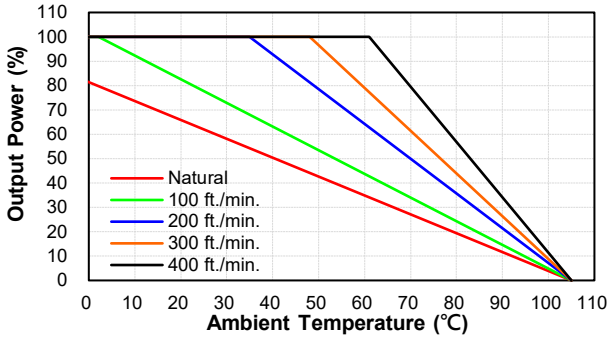

CQB150W-110S05,12,15 Derating Curve without Heatsink (Vin=110V)

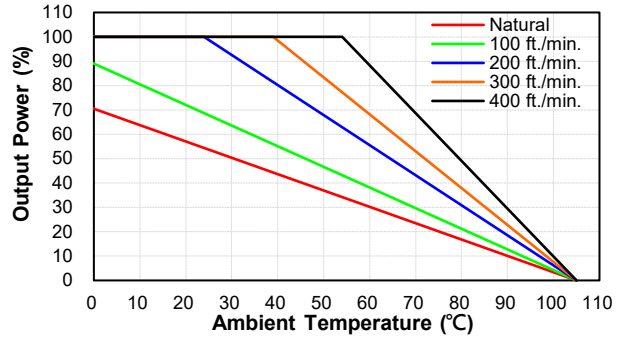

CQB150W-110S48 Derating Curve without Heatsink (Vin=110V)

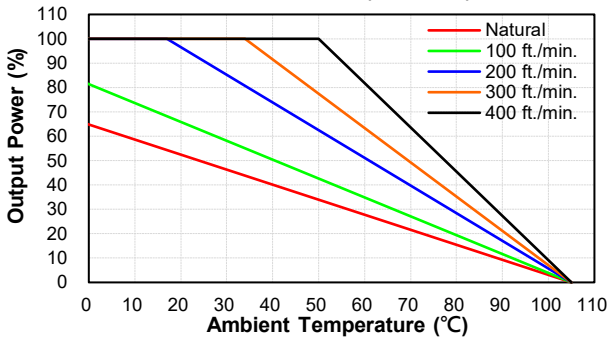

CQB150W-110S3V3,24,28 Derating Curve with Heatsink QBL127 (Vin=110V)

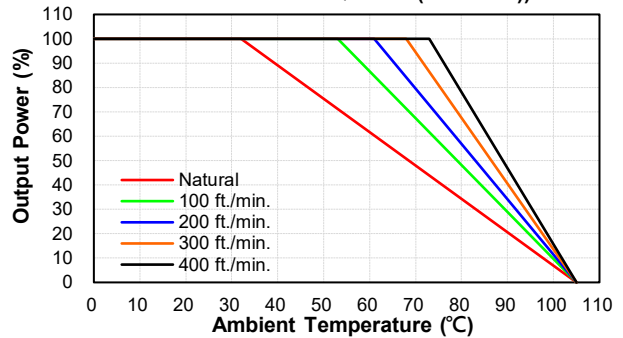

CQB150W-110S05,12,15 Derating Curve with Heatsink QBL127 (Vin=110V)

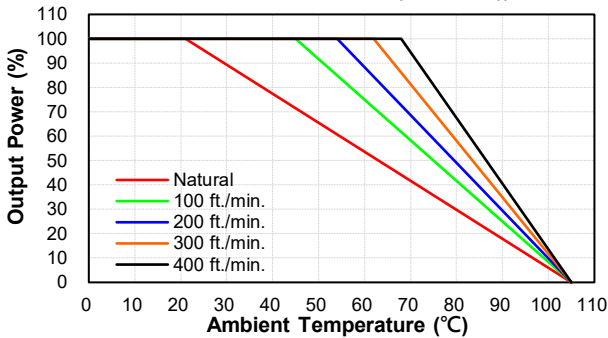

CQB150W-110S48 Derating Curve with Heatsink QBL127 (Vin=110V)

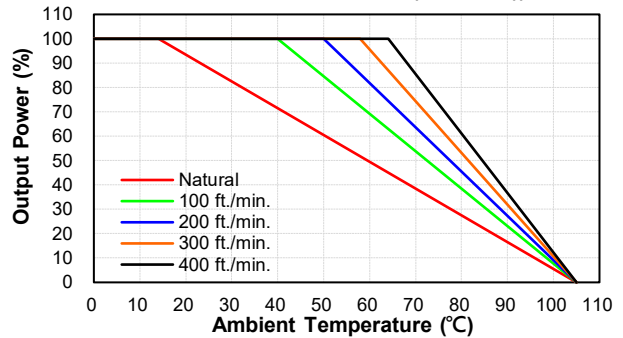

CQB150W-110S3V3,24,28 Derating Curve with Heatsink QBT210 (Vin=110V)

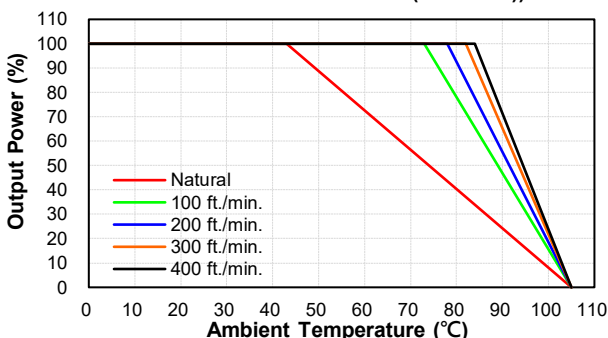

CQB150W-110S05,12,15 Derating Curve with Heatsink QBT210 (Vin=110V)

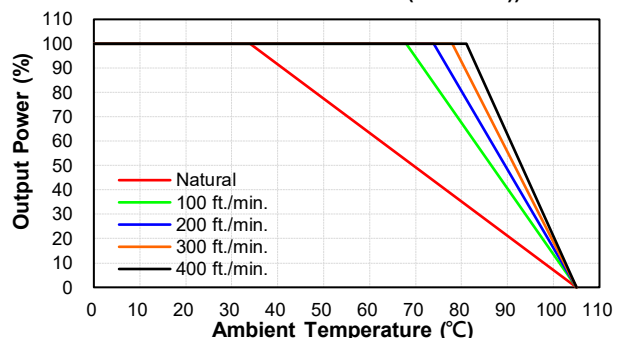



CQB150W-110S Series

CQB150W-110S48 Derating Curve with Heatsink QBT210 (Vin=110V)

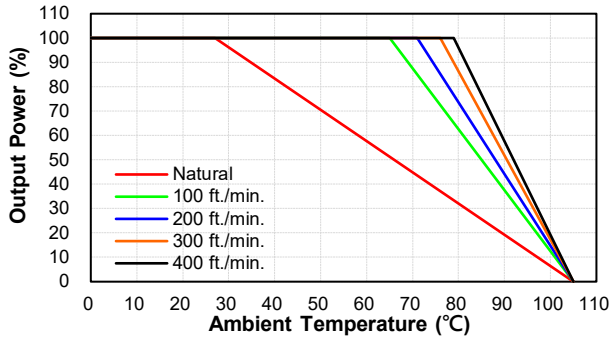

Performance Data

CQB150W-110S3V3 Eff Vs Io @25 Deg. C

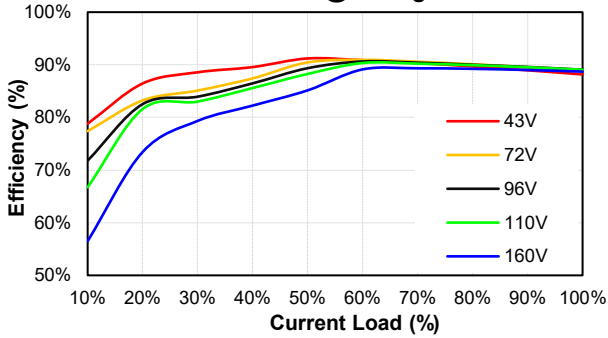

CQB150W-110S3V3 Pd Vs Po @25 Deg. C

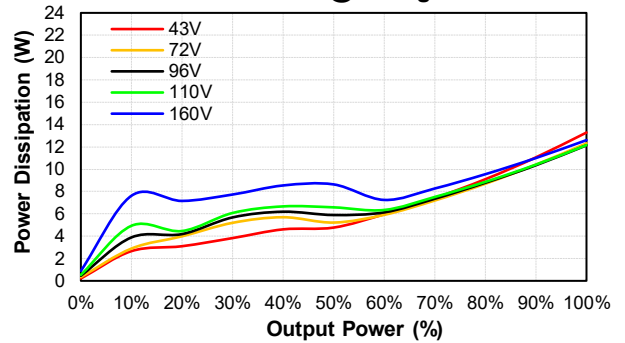

CQB150W-110S05 Eff Vs Io @25 Deg. C

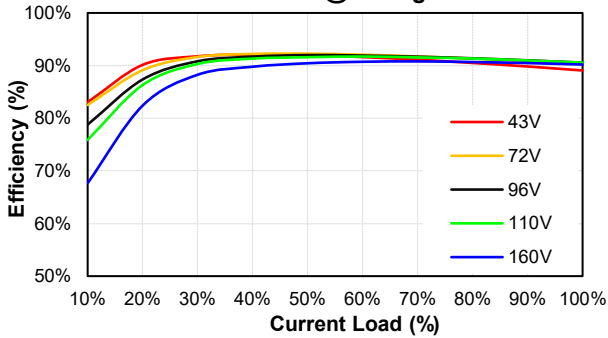

CQB150W-110S05 Pd Vs Po @25 Deg. C

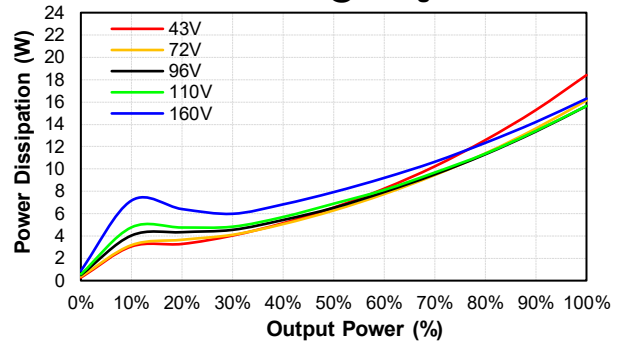

CQB150W-110S12 Eff Vs Io @25 Deg. C

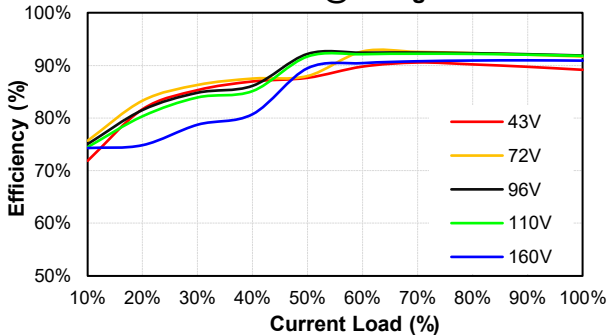

CQB150W-110S12 Pd Vs Po @25 Deg. C

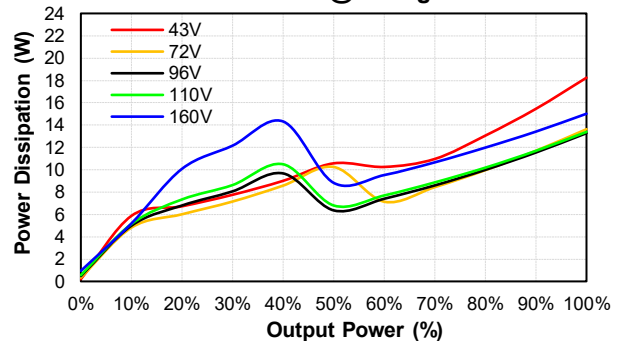



CQB150W-110S Series

CQB150W-110S15
Eff Vs Io @25 Deg. C

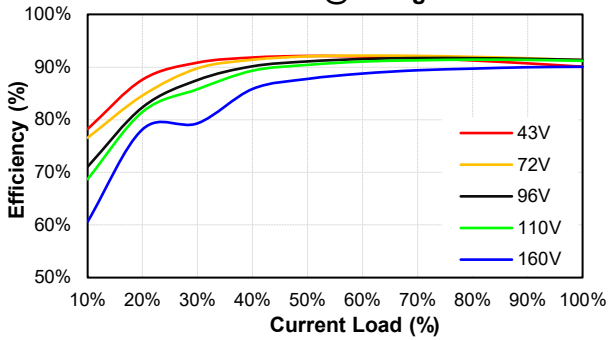

CQB150W-110S15
Pd Vs Po @25 Deg. C

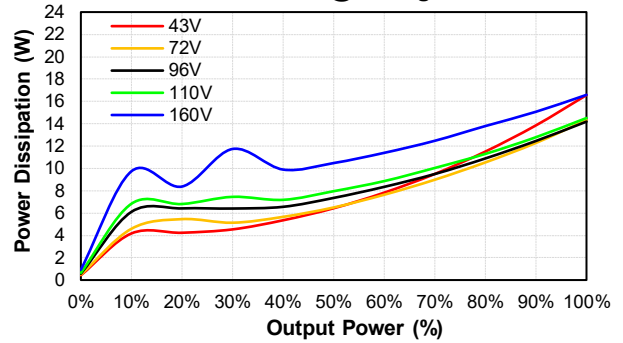

CQB150W-110S24
Eff Vs Io @25 Deg. C

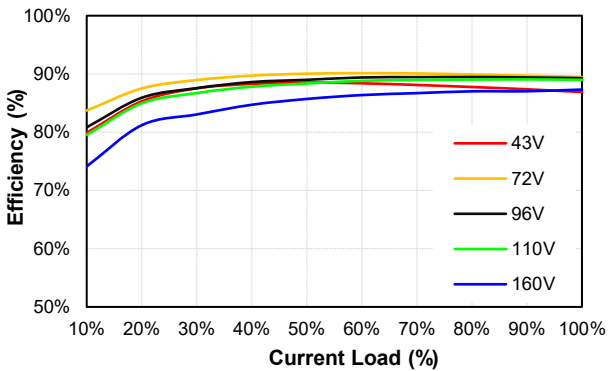

CQB150W-110S24
Pd Vs Po @25 Deg. C

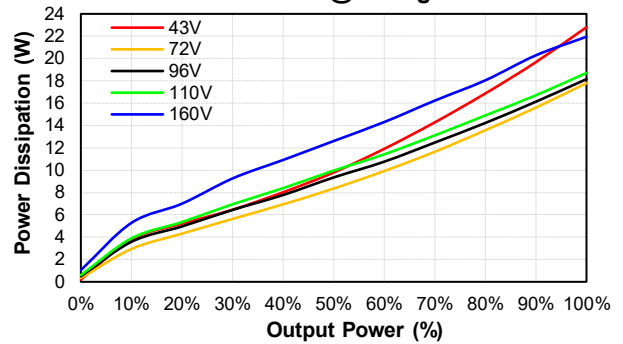

CQB150W-110S28
Eff Vs Io @25 Deg. C

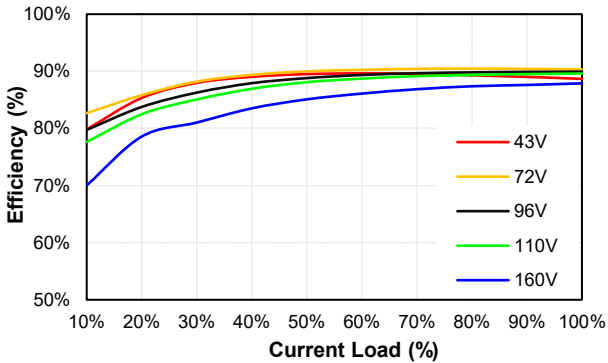

CQB150W-110S28
Pd Vs Po @25 Deg. C

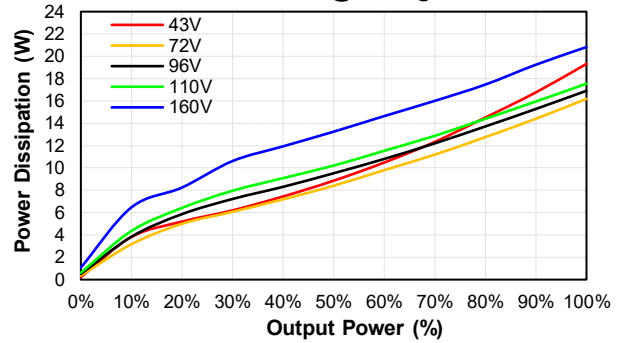

CQB150W-110S48
Eff Vs Io @25 Deg. C

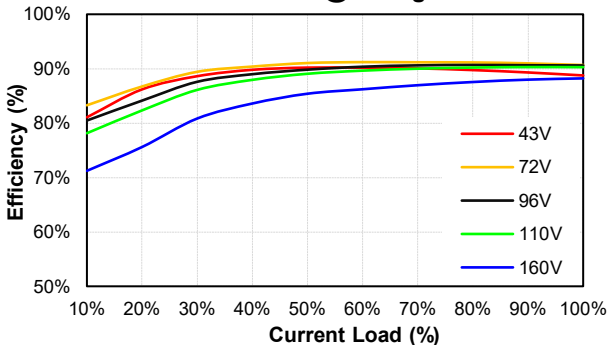

CQB150W-110S48
Pd Vs Po @25 Deg. C

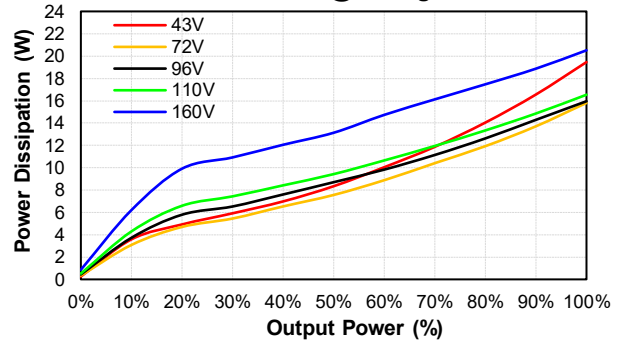



CQB150W-110S Series

MECHANICAL SPECIFICATION

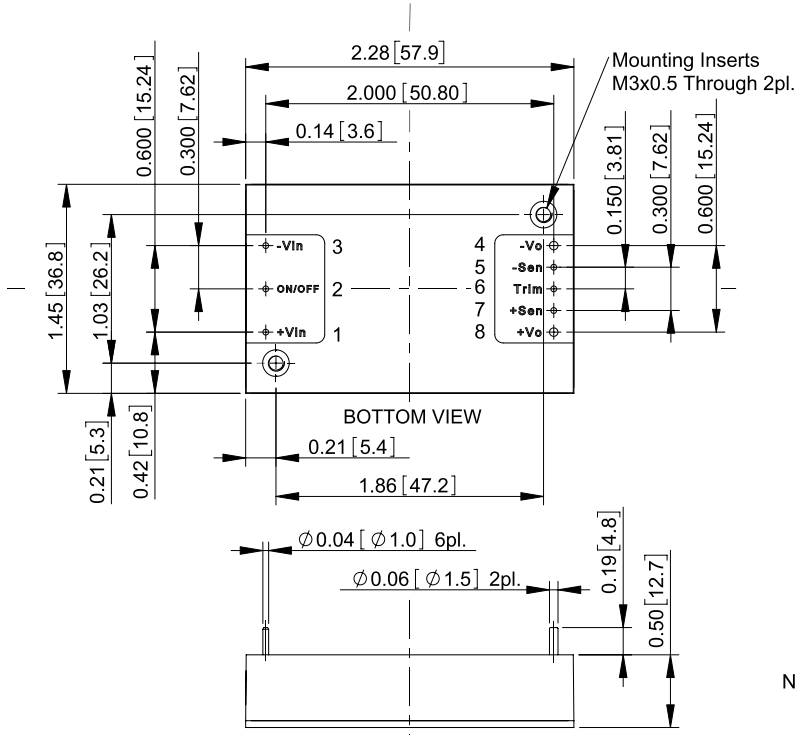

All Dimensions in Inches[mm]
Tolerance Inches: x.xx=±0.02, x.xxx=±0.010
Millimeters: x.x=±0.5, x.xx=±0.25

Pin Connection

Pin	Function
1	+V Input
2	On/Off
3	-V Input
4	-V Output
5	-Sense
6	Trim
7	+Sense
8	+V Output

Note: Pin Size is $\varnothing 0.04 \pm 0.004$ Inch [$\varnothing 1.0 \pm 0.1$ mm]
Pin Size is $\varnothing 0.06 \pm 0.004$ Inch [$\varnothing 1.5 \pm 0.1$ mm]

Mouser Electronics

Authorized Distributor

Click to View Pricing, Inventory, Delivery & Lifecycle Information:

[Cincon:](#)

[CQB150W-110S28N-C](#) [CQB150W-110S12N-C](#) [CQB150W-110S24N-C](#) [CQB150W-110S05N-C](#) [CQB150W-110S28-](#)
[C](#) [CQB150W-110S48N-C](#) [CQB150W-110S24-C](#)