



TIP120, TIP121, TIP122 TIP125, TIP126, TIP127

Complementary power Darlington transistors

Features

- Low collector-emitter saturation voltage
- Complementary NPN - PNP transistors

Applications

- General purpose linear and switching

Description

The devices are manufactured in planar technology with “base island” layout and monolithic Darlington configuration. The resulting transistors show exceptional high gain performance coupled with very low saturation voltage.



Figure 1. Internal schematic diagrams



Table 1. Device summary

Order codes	Marking	Package	Packaging
TIP120	TIP120	TO-220	Tube
TIP121	TIP121		
TIP122	TIP122		
TIP125	TIP125		
TIP126	TIP126		
TIP127	TIP127		

Content

1	Electrical ratings	3
2	Electrical characteristics	4
	2.1 Electrical characteristics (curves)	5
3	Test circuits	7
4	Package mechanical data	8
5	Revision history	11

1 Electrical ratings

Table 2. Absolute maximum rating⁽¹⁾

Symbol	Parameter	Value				Unit
		NPN	TIP120	TIP121	TIP122	
		PNP	TIP125	TIP126	TIP127	
V_{CBO}	Collector-base voltage ($I_E = 0$)	60	80	100	V	
V_{CEO}	Collector-emitter voltage ($I_B = 0$)	60	80	100	V	
V_{EBO}	Emitter-base voltage ($I_C = 0$)	5			V	
I_C	Collector current	5			A	
I_{CM}	Collector peak current	8			A	
I_B	Base current	0.12			A	
P_{TOT}	Total dissipation at $T_C \leq 25\text{ °C}$ $T_{amb} \leq 25\text{ °C}$	65			W	
		2				
T_{stg}	Storage temperature	-65 to 150			°C	
T_J	Max. operating junction temperature	150				

1. For PNP types voltage and current values are negative.

Table 3. Thermal data

Symbol	Parameter	Value	Unit
$R_{thj-case}$	Thermal resistance junction-case max.	1.92	°C/W
$R_{thj-amb}$	Thermal resistance junction-ambient max.	62.5	

2 Electrical characteristics

($T_{\text{case}} = 25\text{ °C}$; unless otherwise specified)

Table 4. Electrical characteristics⁽¹⁾

Symbol	Parameter	Test conditions	Min.	Typ.	Max.	Unit
I_{CEO}	Collector cut-off current ($I_{\text{B}} = 0$)	for TIP120/125 $V_{\text{CE}} = 30\text{ V}$ for TIP121/126 $V_{\text{CE}} = 40\text{ V}$ for TIP122/127 $V_{\text{CE}} = 50\text{ V}$			0.5 0.5 0.5	mA mA mA
I_{CBO}	Collector cut-off current ($I_{\text{B}} = 0$)	for TIP120/125 $V_{\text{CE}} = 60\text{ V}$ for TIP121/126 $V_{\text{CE}} = 80\text{ V}$ for TIP122/127 $V_{\text{CE}} = 100\text{ V}$			0.2 0.2 0.2	mA mA mA
I_{EBO}	Emitter cut-off current ($I_{\text{C}} = 0$)	$V_{\text{EB}} = 5\text{ V}$			2	mA
$V_{\text{CEO(sus)}}^{(2)}$	Collector-emitter sustaining voltage ($I_{\text{B}} = 0$)	$I_{\text{C}} = 30\text{ mA}$ for TIP120/125 for TIP121/126 for TIP122/127	60 80 100			V V V
$V_{\text{CE(sat)}}^{(2)}$	Collector-emitter saturation voltage	$I_{\text{C}} = 3\text{ A}$ $I_{\text{B}} = 12\text{ mA}$ $I_{\text{C}} = 5\text{ A}$ $I_{\text{B}} = 20\text{ mA}$			2 4	V V
$V_{\text{BE(on)}}^{(2)}$	Base-emitter on voltage	$I_{\text{C}} = 3\text{ A}$ $V_{\text{CE}} = 3\text{ V}$			2.5	V
$h_{\text{FE}}^{(2)}$	DC current gain	$I_{\text{C}} = 0.5\text{ A}$ $V_{\text{CE}} = 3\text{ V}$ $I_{\text{C}} = 3\text{ A}$ $V_{\text{CE}} = 3\text{ V}$	1000 1000			

1. For PNP types voltage and current values are negative.

2. Pulsed duration = 300 μs , duty cycle $\leq 2\%$

2.1 Electrical characteristics (curves)

Figure 2. Safe operating area

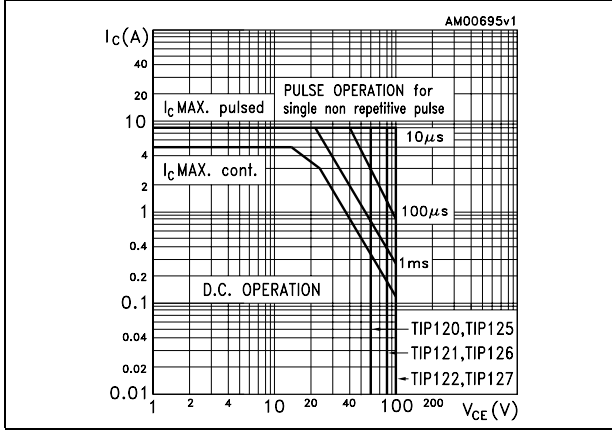

Figure 3. Derating curve

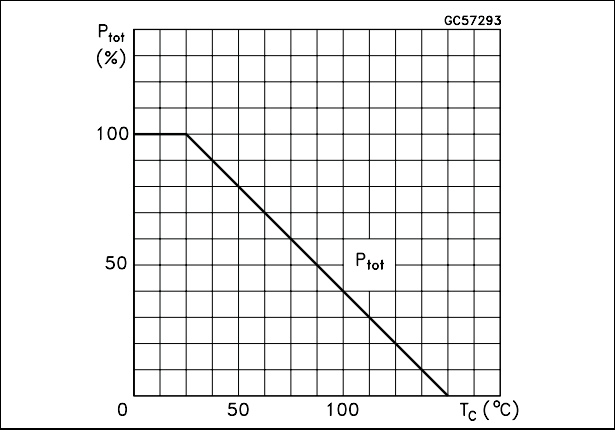

Figure 4. DC current gain for NPN type

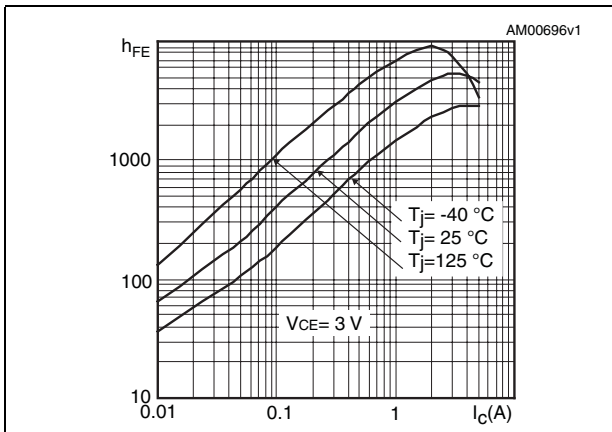

Figure 5. DC current gain for PNP type

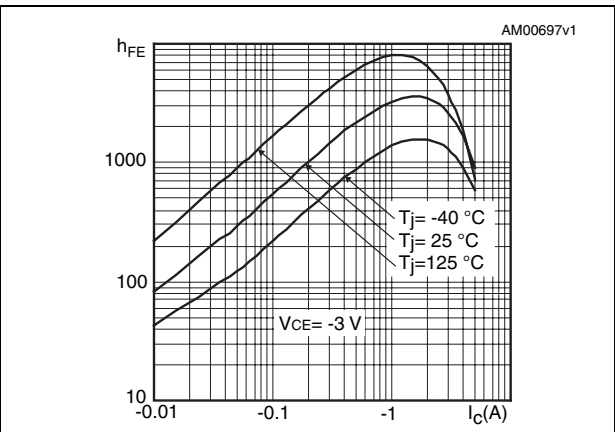

Figure 6. Collector-emitter saturation voltage for NPN type

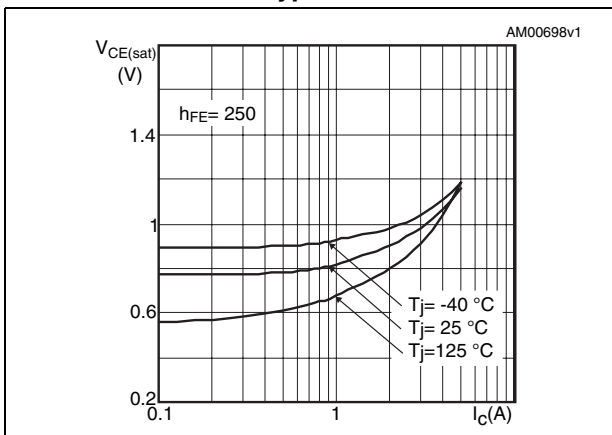

Figure 7. Collector-emitter saturation voltage for PNP type

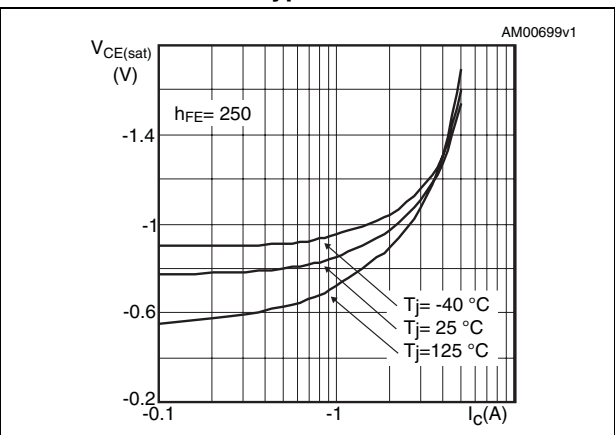

Figure 8. Base-emitter saturation voltage for NPN type



Figure 9. Base-emitter saturation voltage for PNP type

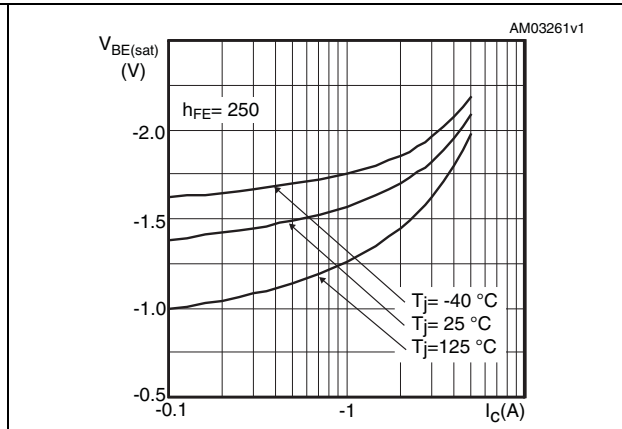

Figure 10. Base-emitter on voltage for NPN type



Figure 11. Base-emitter on voltage for PNP type

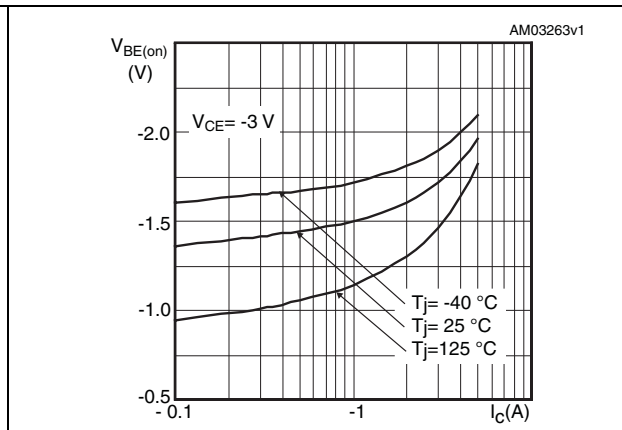

Figure 12. Switching time on resistive load for NPN type (on)



Figure 13. Switching time on resistive load for PNP type (on)

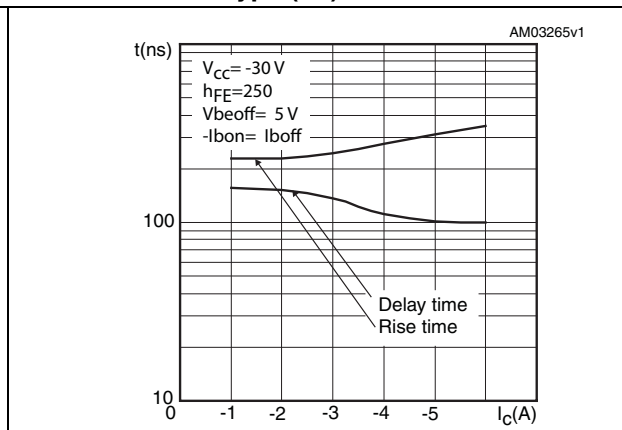

Figure 14. Switching time on resistive load for NPN type (off)

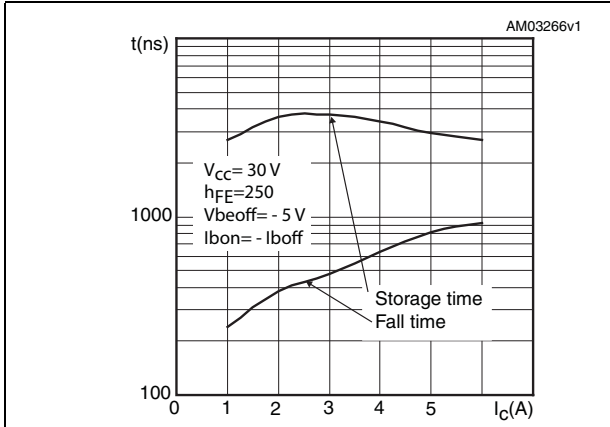

Figure 15. Switching time on resistive load for PNP type (off)

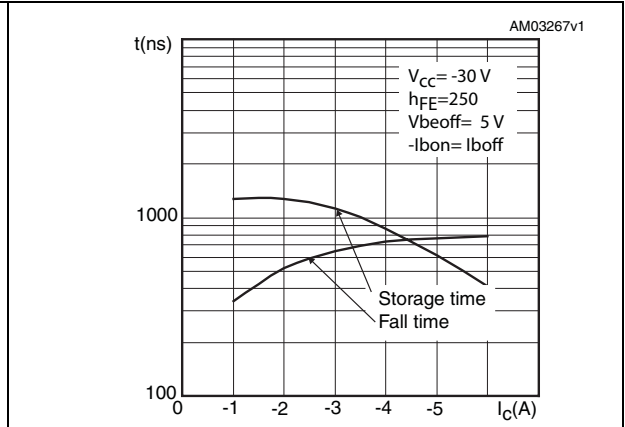

Figure 16. Capacitances for NPN type

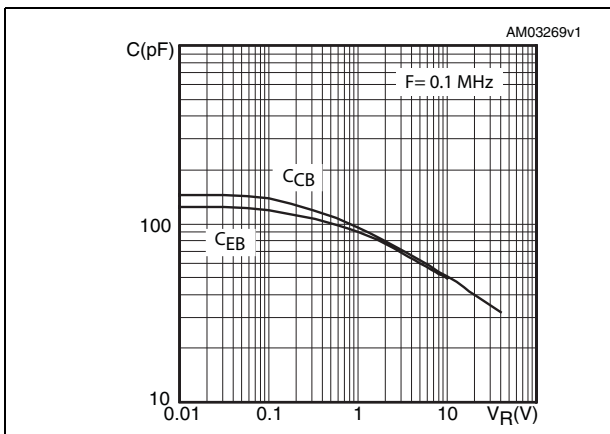
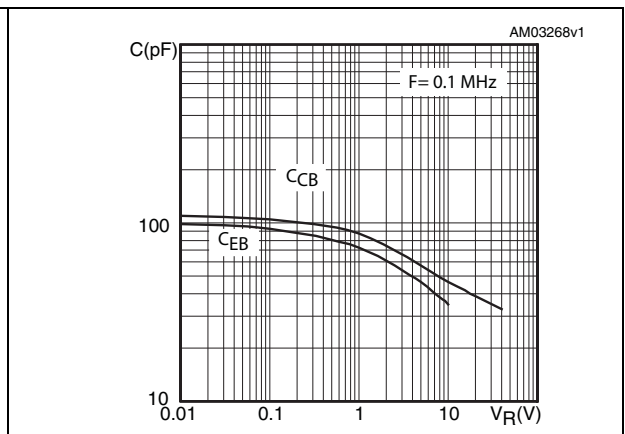

Figure 17. Capacitances for PNP type



3 Test circuits

Figure 18. Resistive load switching for NPN type



Figure 19. Resistive load switching for PNP type



4 Package mechanical data

In order to meet environmental requirements, ST offers these devices in ECOPACK® packages. These packages have a lead-free second level interconnect . The category of second level interconnect is marked on the package and on the inner box label, in compliance with JEDEC Standard JESD97. The maximum ratings related to soldering conditions are also marked on the inner box label. ECOPACK is an ST trademark. ECOPACK specifications are available at: www.st.com

TO-220 mechanical data

Dim	mm			inch		
	Min	Typ	Max	Min	Typ	Max
A	4.40		4.60	0.173		0.181
b	0.61		0.88	0.024		0.034
b1	1.14		1.70	0.044		0.066
c	0.48		0.70	0.019		0.027
D	15.25		15.75	0.6		0.62
D1		1.27			0.050	
E	10		10.40	0.393		0.409
e	2.40		2.70	0.094		0.106
e1	4.95		5.15	0.194		0.202
F	1.23		1.32	0.048		0.051
H1	6.20		6.60	0.244		0.256
J1	2.40		2.72	0.094		0.107
L	13		14	0.511		0.551
L1	3.50		3.93	0.137		0.154
L20		16.40			0.645	
L30		28.90			1.137	
∅P	3.75		3.85	0.147		0.151
Q	2.65		2.95	0.104		0.116



TO-220 type E mechanical data

DIM.	mm.		
	MIN.	TYP	MAX.
A	4.47		4.67
b	0.70		0.91
b1	1.17		1.37
c	0.31		0.53
D	14.60		15.70
E	9.96		10.36
e		2.54	
e1	4.98	5.08	5.18
F	1.17		1.37
H1	6.10		6.80
J1	2.52		2.82
L	12.70		13.80
L1	3.20		3.96
L20	15.21		16.77
øP	3.73		3.94
Q	2.59		2.89

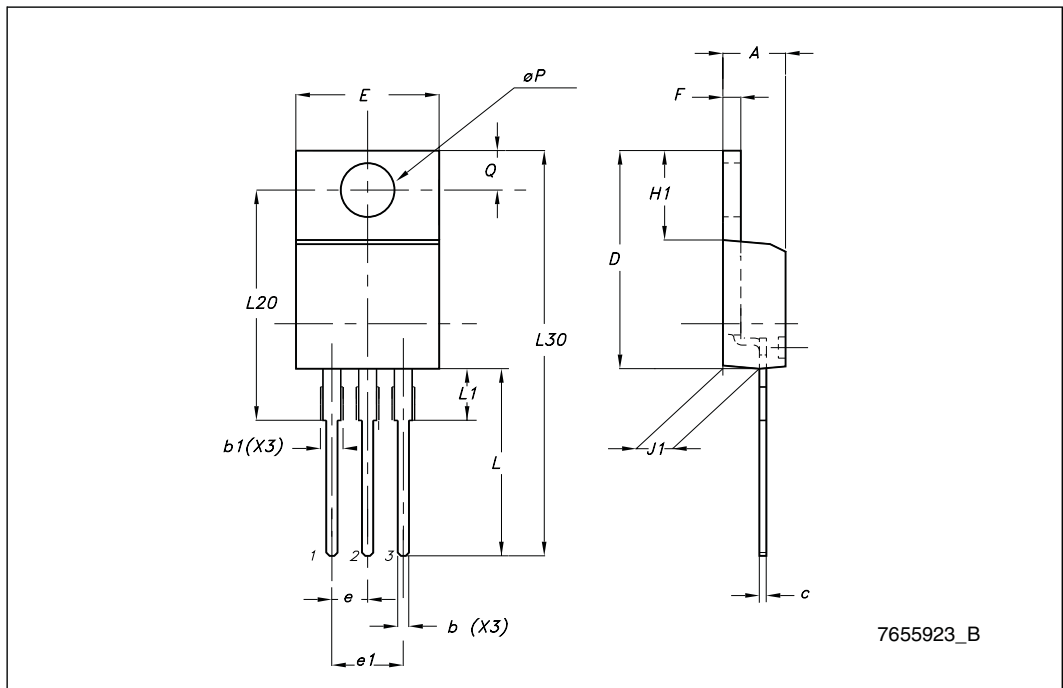

5 Revision history

Table 5. Document revision history

Date	Revision	Changes
21-Jun-2004	3	
25-Nov-2008	4	Inserted new Section 2.1: Electrical characteristics (curves)

Please Read Carefully:

Information in this document is provided solely in connection with ST products. STMicroelectronics NV and its subsidiaries ("ST") reserve the right to make changes, corrections, modifications or improvements, to this document, and the products and services described herein at any time, without notice.

All ST products are sold pursuant to ST's terms and conditions of sale.

Purchasers are solely responsible for the choice, selection and use of the ST products and services described herein, and ST assumes no liability whatsoever relating to the choice, selection or use of the ST products and services described herein.

No license, express or implied, by estoppel or otherwise, to any intellectual property rights is granted under this document. If any part of this document refers to any third party products or services it shall not be deemed a license grant by ST for the use of such third party products or services, or any intellectual property contained therein or considered as a warranty covering the use in any manner whatsoever of such third party products or services or any intellectual property contained therein.

UNLESS OTHERWISE SET FORTH IN ST'S TERMS AND CONDITIONS OF SALE ST DISCLAIMS ANY EXPRESS OR IMPLIED WARRANTY WITH RESPECT TO THE USE AND/OR SALE OF ST PRODUCTS INCLUDING WITHOUT LIMITATION IMPLIED WARRANTIES OF MERCHANTABILITY, FITNESS FOR A PARTICULAR PURPOSE (AND THEIR EQUIVALENTS UNDER THE LAWS OF ANY JURISDICTION), OR INFRINGEMENT OF ANY PATENT, COPYRIGHT OR OTHER INTELLECTUAL PROPERTY RIGHT.

UNLESS EXPRESSLY APPROVED IN WRITING BY AN AUTHORIZED ST REPRESENTATIVE, ST PRODUCTS ARE NOT RECOMMENDED, AUTHORIZED OR WARRANTED FOR USE IN MILITARY, AIR CRAFT, SPACE, LIFE SAVING, OR LIFE SUSTAINING APPLICATIONS, NOR IN PRODUCTS OR SYSTEMS WHERE FAILURE OR MALFUNCTION MAY RESULT IN PERSONAL INJURY, DEATH, OR SEVERE PROPERTY OR ENVIRONMENTAL DAMAGE. ST PRODUCTS WHICH ARE NOT SPECIFIED AS "AUTOMOTIVE GRADE" MAY ONLY BE USED IN AUTOMOTIVE APPLICATIONS AT USER'S OWN RISK.

Resale of ST products with provisions different from the statements and/or technical features set forth in this document shall immediately void any warranty granted by ST for the ST product or service described herein and shall not create or extend in any manner whatsoever, any liability of ST.

ST and the ST logo are trademarks or registered trademarks of ST in various countries.

Information in this document supersedes and replaces all information previously supplied.

The ST logo is a registered trademark of STMicroelectronics. All other names are the property of their respective owners.

© 2008 STMicroelectronics - All rights reserved

STMicroelectronics group of companies

Australia - Belgium - Brazil - Canada - China - Czech Republic - Finland - France - Germany - Hong Kong - India - Israel - Italy - Japan - Malaysia - Malta - Morocco - Singapore - Spain - Sweden - Switzerland - United Kingdom - United States of America

www.st.com

Mouser Electronics

Authorized Distributor

Click to View Pricing, Inventory, Delivery & Lifecycle Information:

[STMicroelectronics:](#)

[TIP122](#) [TIP120](#) [TIP125](#) [TIP127](#) [TIP121](#)